

Lawrence Berkeley National Laboratory

Recent Work

Title

Journal of Glenn T. Seaborg: Chief, Section C-1, Metallurgical Laboratory, Manhattan Engineer District, 1942-46 (Volume 2)

Permalink

<https://escholarship.org/uc/item/0cd8248m>

Author

Seaborg, G.T.

Publication Date

1992-08-01

PUB-112
Vol. 1
Reprinted 9/92

JOURNAL OF

GLENN T. SEABORG

Chief, Section C-1, Metallurgical Laboratory,
Manhattan Engineer District
1942-1946

April 19, 1942 - April 30, 1943

Lawrence Berkeley Laboratory
University of California

Prepared for the U.S. Department of Energy under Contract DE-AC03-76SF00098

REFERENCE COPY		PUB-112 Vol. 1
Does Not		Copy 1
Circulate		
	Bldg. 50	Library.

DISCLAIMER

This document was prepared as an account of work sponsored by the United States Government. Neither the United States Government nor any agency thereof, nor The Regents of the University of California, nor any of their employees, makes any warranty, express or implied, or assumes any legal liability or responsibility for the accuracy, completeness, or usefulness of any information, apparatus, product, or process disclosed, or represents that its use would not infringe privately owned rights. Reference herein to any specific commercial products process, or service by its trade name, trademark, manufacturer, or otherwise, does not necessarily constitute or imply its endorsement, recommendation, or favoring by the United States Government or any agency thereof, or The Regents of the University of California. The views and opinions of authors expressed herein do not necessarily state or reflect those of the United States Government or any agency thereof or The Regents of the University of California and shall not be used for advertising or product endorsement purposes.

Lawrence Berkeley Laboratory is an equal opportunity employer.

DISCLAIMER

This document was prepared as an account of work sponsored by the United States Government. While this document is believed to contain correct information, neither the United States Government nor any agency thereof, nor the Regents of the University of California, nor any of their employees, makes any warranty, express or implied, or assumes any legal responsibility for the accuracy, completeness, or usefulness of any information, apparatus, product, or process disclosed, or represents that its use would not infringe privately owned rights. Reference herein to any specific commercial product, process, or service by its trade name, trademark, manufacturer, or otherwise, does not necessarily constitute or imply its endorsement, recommendation, or favoring by the United States Government or any agency thereof, or the Regents of the University of California. The views and opinions of authors expressed herein do not necessarily state or reflect those of the United States Government or any agency thereof or the Regents of the University of California.

Journal
of
GLENN T. SEABORG
1942-1946

VOLUME 1

PREFACE

Some ten years ago it occurred to me that it might be interesting, and perhaps useful, to prepare a history of the research work of the many chemists who worked with me in the University of Chicago Metallurgical Laboratory during World War II. The work of these groups, which were affiliated under my direction in a unit which became known as "Chemistry Section C-I" as part of a broader Chemistry Division, was concerned with the development of chemical procedures for the extraction of plutonium, for the purification of plutonium, and, in the later phases, for research on the isotopes of other heavy elements including other transuranium elements. The idea for such a writing project came to me at the time of the reunion of Metallurgical Laboratory chemists at the University of Chicago on the occasion of the observance of the 25th anniversary of the first weighing of plutonium; the renewed contact with so many of my old friends on this day of nostalgia and reminiscence (September 10, 1967) imbued in me the desire to recapture, in some sense, more of those interesting days which in many ways I regard as the most exciting in my life.

When I explored this somewhat unorthodox idea with Joe Katz, my longtime friend and co-worker in the Metallurgical Laboratory, he encouraged me to proceed; more than that, and most importantly, he offered to lend some help. We both recalled that there should be many reports, notes of meetings, laboratory notebooks, etc., that should make such a task feasible. A perusal of the available material, mainly in the files at Argonne National Laboratory (successor to the Metallurgical Laboratory) and my files at the Radiation Laboratory in Berkeley, revealed an even greater potential than we had realized. Encouraged by this discovery, I decided to undertake the writing on a basis in which our activities would be described, as they had occurred, day by day. This, then, would amount to a reconstruction of a daily journal covering that period, starting with the date of my arrival in Chicago on April 19, 1942, and hopefully extending until my departure in May 1946.

Joe arranged to have a capable research assistant, Carol Flaumenhaft, who was spending a year's sabbatical (during 1969-1970) together with her husband at the Argonne National Laboratory, help me on this project. Carol located and collated an astonishing amount of the material with the help of Doral Buchholz, my former secretary at the Radiation Laboratory in Berkeley. We found some 60 categories of information, including a wide range of Met Lab Progress Reports, notes on meetings, an almost complete file of all the laboratory notebooks, personnel records, patent files, travel vouchers, organization charts, records of pile and cyclotron bombardments, health monitoring records, administrative bulletins, etc. Unfortunately, I did not keep a diary, but we were able to locate hundreds of notes I had taken to cover meetings, telephone calls, etc; these were often written in a style that amounted to a code (in order to protect the secret nature of the information), but fortunately I found it possible to decipher them. This was one of the most important categories of information, as was the file of meeting notes (such note taking wasn't inaugurated until 1943) which had been issued as informal reports and which fortunately usually included names of the attendees.

I searched avidly for diaries that might have been kept by any of the people who worked for me. Such a practice was, of course, frowned upon at the time, and unfortunately I had little success in locating such sources of information. A notable exception was a diary kept by Elwin Covey, a research assistant in my Section, covering his Chicago period from the date of his arrival in May 1942 until the date of his departure for Clinton Laboratories in August 1943 (a segment of a more extensive diary). Covey kindly placed at my disposal this diary, which was very helpful despite its limitations imposed by his non-research role. Another welcome exception was a very brief diary, actually an intermittent daily notation of a few words in a small pocket-size appointment book, kept by my wife Helen; this made it possible to include a large number of entries concerning our social life during most of the period 1942-1946 when we were in Chicago.

With much accumulated material to furnish a working base, I enlisted the help at AEC headquarters of Sydney Gaarder, who had worked with me in Met Lab Section C-I and later at Clinton Laboratories and the Hanford Engineer Works, to help gather more material and especially to help with

the writing. Syd was admirably suited to this task and produced an excellent first draft while on this assignment during 1970 and 1971. With the help of Robert L. Butenhoff, who also worked with me for a time in Met Lab Section C-I, Syd covered the months from April 1942 until early 1946.

My return to Berkeley in the fall of 1971 interrupted the task of refining this first draft due to the pressure of other duties. However, at this time I gathered material for a prelude to this account an "Early History of Heavy Isotope Research at Berkeley: August, 1940 to April, 1942" which was issued in June, 1976. When I returned to the task in 1974, I enlisted the help of Bernard Saunders, a physicist who had worked during the war on the electromagnetic uranium isotope enrichment process at both Berkeley and Oak Ridge. At this time Bernie and I expanded the scope considerably, making the project even more ambitious than envisioned while I was working on it in Washington.

The style evolved into this present format in which the entry for each day is written as though it was entered in a diary on the basis of information available to me at the end of the day. There is more reliance on quotations from letters, written or received, than would be usual for an actual diary, which is justified on the basis that this kind of information comes closest to emulating a diary. An exception to this style of diary imitation is the footnotes that are included to give additional background material; these go beyond the activities of Chemistry Section C-I, covering meetings that I did not attend, and hence often include information that I could not have had on those entry dates.

Essentially all of the events, and the dates on which they are recorded, are based on the numerous categories of documentation; only a very small portion is based on memory alone, and even then it is usually associated with related information based on documentation. Chicago newspapers for this period, available in libraries, and weather records were used to embellish the narrative with some additional information on current events.

To help me in this writing task I wrote and talked to many who participated with me in the Met Lab experience to seek their recollections to augment the documented record. Among those who responded with welcome information for this volume are Bernie Abraham, Edrey (Smith) Albaugh, Larry Asprey, George Boyd, Milton Burton, Elwin Covey, John and Lorraine

Crawford, the late Burris Cunningham, Norm Davidson, Jon Dixon, Paul Fields, Al and Kay Florin, Mark Fred, Mel Freedman, Albert Ghiorso, Larry Glendenin, Bertrand Goldschmidt, Orville Hill, Clark Hindman, Henry Hoekstra, Jerry Howland, Earl Hyde, the late Herb Hyman, Art Jaffey, Walter Jilek, Leonard Katzin, Bill Knox, Truman Kohman, Dan Koshland, Howard Lange, Steve Lawroski, John Malm, Dan Miller, Herman Robinson, Paul Schulze, Ben Scott, Jake Sedlet, Irving Sheft, Oliver Simpson, Clifford Smith, Ellis Steinberg, Don Stewart, Nate Sugarman, the late Stan Thompson, Frank Tompkins, Elton Turk, Pat Walsh, Louis Werner and John Willard. Since photography was not encouraged, the supply of illustrations is limited. Again Elwin Covey is an exception and most of the illustrations are due to him. Snapshots were also furnished by Iz Perlman and Luther Peery.

The project has grown to the point where publication requires several volumes rather than one volume as originally planned. The first of these, and I am not sure how many others there will be, is being published here under the title Met Lab Section C-I, April 1942-April 1943. I am indebted to E. Newman Pettitt, Sophie Stephens, John Farmakes, Harry Macy and Margaret Fieldhouse of the Argonne National Laboratory and ERDA Chicago Operations Office for help in gathering material, and to Sylvia Kihara, Margie Hollander, Kathleen Van Der Haeghen and Helen Seaborg for much help in putting this volume into publishable form.

APRIL 1942

Sunday, April 19, 1942

This morning at 9:30 a.m. Isadore Perlman and I arrived in Chicago aboard the City of San Francisco. Although our trip from Berkeley took almost two full days, we feel that the time has not been wasted. Many lively discussions ensued in the privacy of our bedroom and, with appropriate care, in the club car regarding ways to separate element 94 chemically from uranium (that will be neutron-irradiated in chain-reacting piles) and from the fission by-products that will be produced concurrently in the neutron-irradiation process. This overall problem of element 94 isolation will occupy most of our attention for some time to come. The work of my group in the Department of Chemistry at the University of California, Berkeley, during the period August 1940 to the present, has produced much of the background information which is the basis of the Metallurgical Project. (This is the code name for the project whose mission is to produce fissionable element 94 in sufficient quantity for use in a nuclear weapon, and the project is centered at the University of Chicago.)

Our research at Berkeley has resulted in the discovery of element 94, demonstration of the slow neutron fissionability of its isotope 94^{239} , discovery and demonstration of the slow neutron fissionability of U^{233} , spontaneous fission measurements on these isotopes, discovery of 93^{237} , isolation of and nuclear measurements on U^{234} , study of the chemical properties and methods of chemical separation and isolation of element 94, demonstration of the presence of small concentrations of 94 in nature and much related information.

I have known Perlman since our undergraduate days at UCLA. When I went to Berkeley to begin my graduate work, he also transferred to Berkeley to complete his work for a B.S. degree in chemistry. He later obtained his Ph.D. in physiology at Berkeley and after some postdoctoral work there joined my group in January and soon became a key man in this effort.

4/19/42

When we stepped into the street from the Chicago and Northwestern Railroad Station at Canal and Madison Streets the temperature was a cold 40°F, a rather sharp contrast to that in Berkeley when we left. Staring us in the face was the headline in the Chicago Sun, "Tokyo Fears New Bombings; Reports Fires in Four Cities" with sub-heads "Five-Hour Raid on Japanese Laid to Yanks" and "Capital, Yokohama, Kobe and Nagoya Blasted." The account went on to say, "Earlier Japanese broadcasts said attacks, which began at noon yesterday, were carried out by high-flying United States planes which swept in from several directions and started fires among the flimsy wood and paper homes of the heavily populated areas," and continued with, "Neither Washington nor General Douglas MacArthur's headquarters of the United Nations forces in Australia would say that Japan has been attacked by air."

We took a cab from the station to the Shoreland Hotel (55th Street at Lake Michigan) near the University of Chicago campus. We registered here and about noon returned to the downtown area via the Illinois Central commuter line. Following lunch we attended the Chicago Theater for a Sunday matinee and saw a stage show featuring Kay Kayser's band and a movie, "Design for Scandal," with Walter Pidgeon. We had dinner, returned here to our hotel, after which I wrote a letter to Helen, my bride-to-be.

This day marks my 30th birthday and a transition point in my life, for tomorrow I will take on the added responsibility of the 94 chemistry group at the Metallurgical Laboratory on the University of Chicago campus, the central component of the Metallurgical Project.

Monday, April 20, 1942

Iz Perlman and I are now official members of the Metallurgical Laboratory, University of Chicago campus (Figure 1), and my salary for the time being has been set at \$360 per month by Dick Doan, who has the title of Laboratory Director. I was shown to my new office in Eckhart Hall (Figure 2), headquarters of the University of Chicago Department of

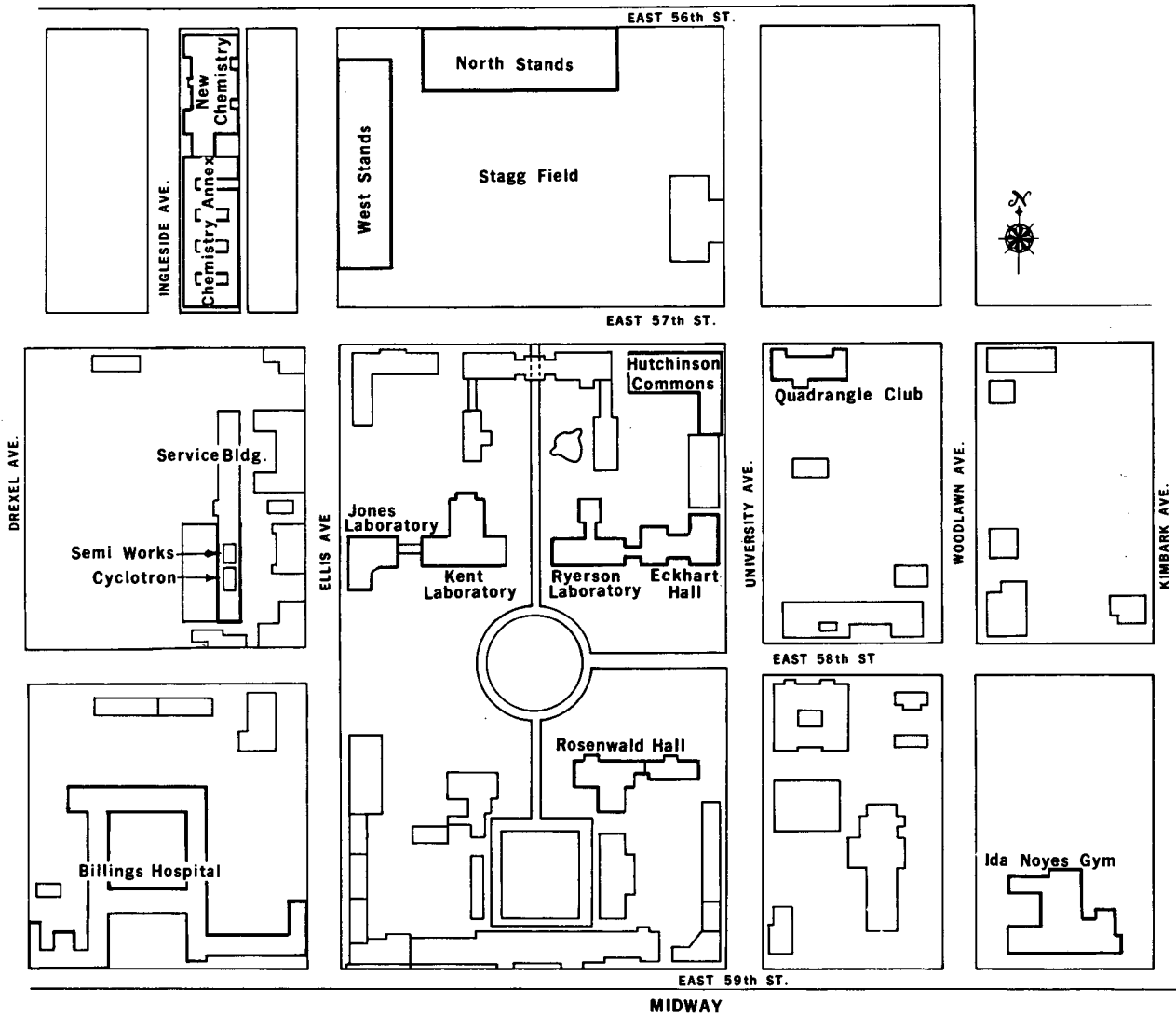

Fig. 1 Map of University of Chicago campus, 1942, with emphasis on buildings mentioned in text. (XBL 757-3432)

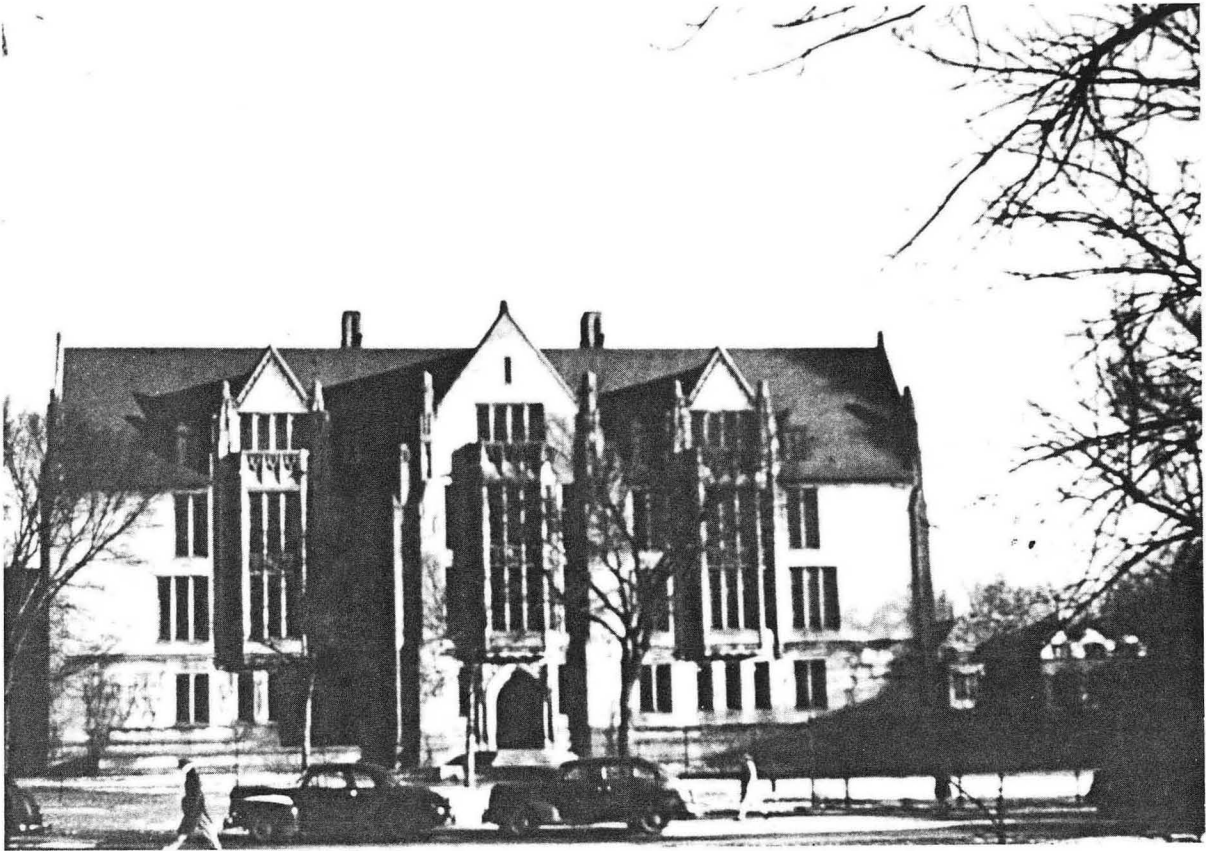

Fig. 2 Eckhart Hall. (CBB 768-7446)

4/20/42

Physics, on the campus; I was also introduced to my new but temporary secretary, Mrs. Lucartha P. Sullivan.

We went by to greet Arthur H. Compton, Director of the Metallurgical Project, in his office (Room 313, Eckhart Hall). We also met his secretary, Kay Tracy, a very competent woman who is obviously playing a key role in helping Compton in his duties. Norman Hilberry, serving as the chief assistant to Compton, has his office next door. The other main building of the Metallurgical Laboratory is Ryerson Laboratory (Figure 3), the other physics building on the campus; most of the participants in the Metallurgical Laboratory are housed in parts of these two buildings which are also still being used for University of Chicago classes.

So far, Iz and I are the only ones on the staff of the new chemistry group, and our laboratory space has not yet been assigned. One of the first orders of business today was to find a capable person to handle procurement and other technical services for my group. I suggested Elwin H. Covey of Berkeley to Joyce C. Stearns, the Lab's Personnel Director, and he responded immediately with a telegram to Covey, offering him the job. I spoke to Covey about this possibility last Friday, just before I left the Berkeley campus.

I had lunch at the Quadrangle Club with Hans von Halban, a former colleague of Curie-Joliot who is visiting here from the British Project, and with Joseph W. Kennedy, my colleague, who along with Arthur C. Wahl came here from Berkeley to attend the forthcoming (April 22-23) chemistry conference at the Metallurgical Lab. (Kennedy was my colleague on our Berkeley heavy isotope research program, and Wahl has just finished his Ph.D. thesis work on element 94 with me.) Halban urged us, as no doubt he has others, to think about how to produce U^{233} as an alternative explosive ingredient for the atomic bomb in case 94^{239} should prove to be inapplicable. I must say that Halban does not share my enthusiasm nor my optimism about the feasibility of separating element 94 in the low concentrations that we will be producing in the graphite-moderated piles. Before we parted I presented him with some reports covering the

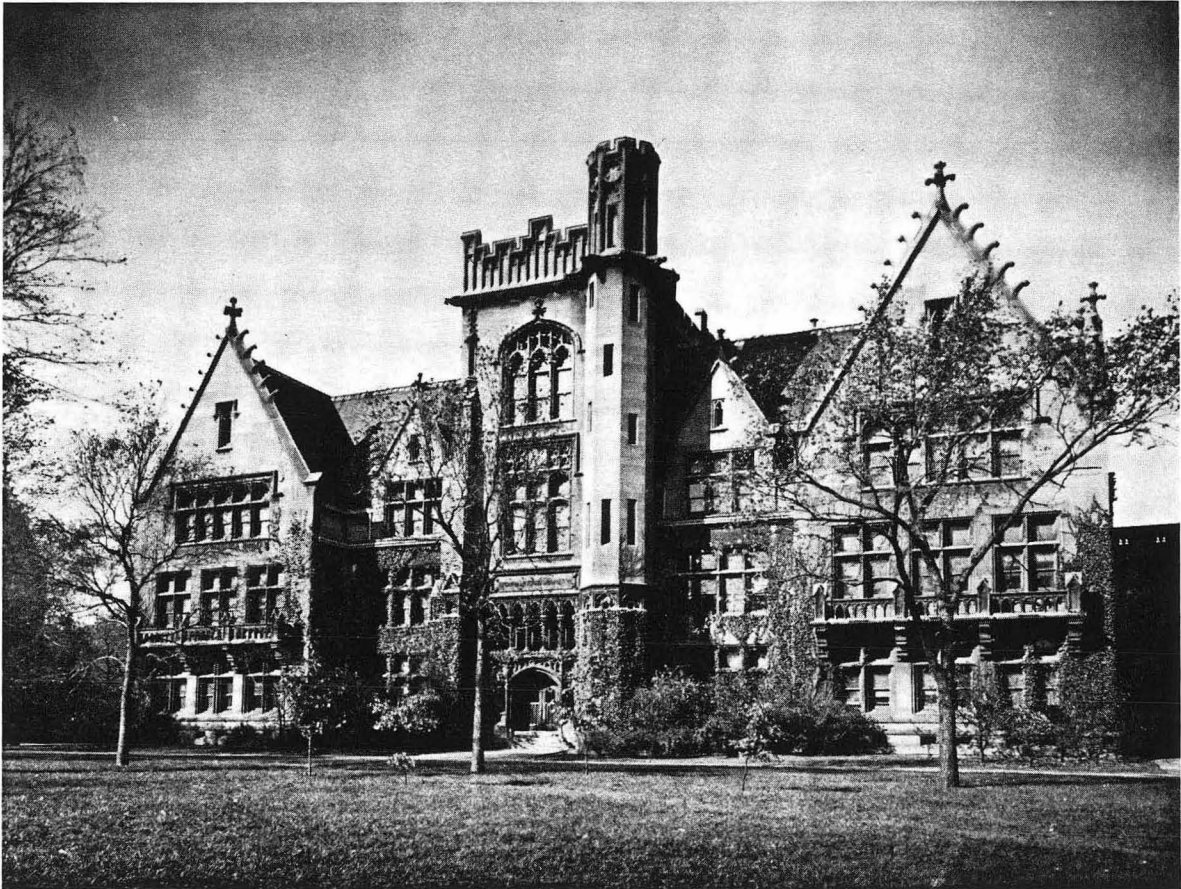

Fig. 3 Ryerson Laboratory (XBB 768-7448)

4/20/42

work of my group in Berkeley: "Chemical Properties of Elements 94 and 93" by G. T. Seaborg and A. C. Wahl; "Search for Elements 94 and 93 in Nature. Presence of 94^{239} in Pitchblende" by G. T. Seaborg and Morris L. Perlman; "Properties of 93^{237} " by A. C. Wahl and G. T. Seaborg; "Properties of U^{233} (Abstract)" by G. T. Seaborg, J. W. Gofman and R. W. Stoughton; "Production and Properties of 50-year Element 94" by G. T. Seaborg, A. C. Wahl and J. W. Kennedy; "Search for Spontaneous Fission in 50-year 94" by S. G. English and G. T. Seaborg; "Preparation of U^{234} Through UX_1 " by I. Perlman and B. J. Fontana; "Slow Neutron Fission of U^{234} " by J. W. Gofman and G. T. Seaborg; and "Szilard-Chalmers Process for Uranium" by D. S. Breslow and J. W. Hamaker.

Later I talked with John A. Wheeler, a theoretical physicist on the Project from Princeton University, well known as the co-author of the Bohr-Wheeler theory of fission, and whom I saw earlier this year when I visited the Met Lab at Compton's request in February. I gave him three reports: "Properties of 93^{237} ," "Properties of U^{233} (Abstract)" and "Search for Spontaneous Fission in 50-year 94," covering work of my group in Berkeley.

Iz and I had dinner at a restaurant on nearby 63rd Street, a street with many restaurants, stores and shops, a few movie houses, a streetcar line and an elevated train running overhead. This busy street is just a half block south of the Mira-Mar Hotel, where we intend to stay, and represents a rather substantial neighborhood business area. It includes two suburban railroad stations at which outgoing trains from downtown Chicago make stops, the nearby Woodlawn Station and the Englewood Station a few miles west. It is clear that we will have a good many of our meals, other than lunch, in the several restaurants of this location.

Tuesday, April 21, 1942

Perlman and I spent much of the day talking to our new colleagues, planning for our laboratory facilities and supplies and preparing for the conference on the chemistry of 94 that will begin tomorrow.

4/21/42

I also spent a good deal of time continuing my conversations with von Halban. Halban and I had a talk with Compton about the importance of U^{233} as an alternate of 94^{239} .

In my continuing conversation with Compton I raised the question of Ray Stoughton's continuing our neon work (code name for thorium- U^{233} project) in Berkeley. Compton is very eager that he do so, and with all possible speed, as it may play an important part in the general program of the future. As part of our research program at Berkeley, Gofman, Stoughton and I showed that U^{233} has a slow-neutron fission cross section about 25% greater than that of U^{235} . (Gofman is doing his Ph.D. research work with me at Berkeley, continuing there after my departure; he, together with Stoughton, working with me in a postdoctoral capacity, participated in the discovery and demonstration of the slow neutron fissionability of U^{233} .) Also, it may turn out that U^{233} is superior to 94^{239} because more secondary neutrons may be emitted during fission and it is easier to isolate chemically. I wrote to Ray informing him of this decision, which I am sure will please him.

Iz and I moved our personal belongings from the Shoreland Hotel to the Mira-Mar Hotel at 6218 Woodlawn Avenue, my permanent home in Chicago until Helen and I are married in a month or so.

Wednesday, April 22, 1942

Perlman and I had breakfast at the White House restaurant, just around the corner a half block east on 63rd Street. We found good service and adequate quality of food and so will probably patronize this restaurant in the future.

We then went to Room 316 of Eckhart Hall to participate in a two-day conference on chemistry for the 94 project, others present being George E. Boyd, James Franck, Norman Hilberry, Iral B. Johns, Kennedy, Perlman, Ernest W. Thiele, Harold C. Urey, Wahl, Wheeler, Eugene Wigner and H. A. Wilhelm.

4/22/42

Spedding, who is Director of Chemical Research for the Met Lab, although stationed at Iowa State College in Ames, Iowa, opened the meeting and outlined the agenda. He was most emphatic that we chemists keep clear in our minds that there are two goals and two goals only: first, to isolate element 94 from uranium irradiated with neutrons in the pile (the informal name for the uranium chain reactor); and second, to understand all the pertinent chemistry necessary for the construction and operation of the pile. Everything else must be secondary.

As for the first goal, work on the separation of 94 will be under my direction here at Chicago, Johns and Wilhelm at Ames, Kennedy and Wahl at Berkeley. We listed the following methods for the separation of 94 from uranium and fission products as the agenda for the discussion to follow: electrolysis, volatilization, precipitation, extraction between two phases, extraction of uranium leaving 94 behind, metallurgical, adsorption. The opinion was expressed that of these, electrolysis, volatilization, metallurgical and adsorption might be best since these methods could be more adaptable to remote control methods. I, however, expressed confidence in the use of precipitation.

Other subjects listed on the agenda for the forthcoming two-day discussion were fission products (the area in which Charles Coryell will specialize when he arrives at the Met Lab, as well as Johns at Ames), materials research (under Boyd at the Met Lab), processing of materials (Boyd and Herbert N. McCoy at the Met Lab), metallurgical (Wilhelm at Ames), hot testing of pile materials (Wilhelm at Ames), health protection of workers (Robert E. Rundle at Ames), effects of radiation on materials and theoretical considerations. Arrangements for the latter two areas of investigation are yet to be made.

In order to lay a background to show the conditions of high levels of radiations from fission products with which a chemical separation process will have to contend, Wheeler summarized his estimates of total energy liberated at various times up to a year after operation of a 5,000 kw pile for 30 days. This impressed us with the difficulties of dealing with the intense radioactivity involved and the consequent heat, and the requirement that all the operations must be simple and amenable to remote control.

4/22/42

It was pointed out that Compton and the Planning Board (Samuel K. Allison, Richard Doan, Enrico Fermi, Hilberry, Spedding, Leo Szilard, Thiele, Wheeler and Wigner) have decided that the chemistry of 94 is to have a special category of secrecy with the information to be circulated only among the chemists and the Planning Board.

At the end of these introductory considerations we talked about a new terminology for the heavy elements. At Berkeley we have been using the code names "silver" for neptunium (element 93) and "copper" for plutonium (element 94), but this is often confusing and we have been forced to resort to such expressions as "honest-to-God" silver and "honest-to-God" copper when referring to these elements themselves. It was agreed that the names "neptunium" and "plutonium" should not be used as code words for elements 93 and 94 because they might be revealing if overheard. A suggestion was made to base a code on the last digit in the atomic number and in the atomic weight of each isotope, e.g., 49 corresponds to 94^{239} , 39 to 93^{239} , 28 to 92^{238} , 25 to 92^{235} , etc. A motion was made and passed to recommend this numerical notation for consideration to the general group of those working on the project.

We concluded the morning session by discussing the role of each group. For instance, the four chemical groups here at Chicago will be headed by Charles D. Coryell, Boyd, Herbert N. McCoy and me. Coryell, coming to us from UCLA, will be concerned with the chemistry of the fission products. Boyd, a chemistry instructor at the University of Chicago, will have charge of the routine analyses and the chemistry associated with the purification of materials, as well as the room-temperature chemistry involved in the design and operation of the pile, and some work on the adsorption methods for the separation of 94. McCoy, an early investigator in natural radioactivity formerly at the University of Chicago, will be responsible for all chemistry connected with the processing of materials for the pile, in cooperation with T. V. Moore, head of the engineering group. My group primarily will study all methods of 94 separation. At Iowa State College, Ames, where Spedding has set up a branch of the Met Lab, there are three groups, led by Wilhelm, Johns and Rundle. Wilhelm's group will be concerned with the metallurgy of uranium and the metallurgical methods of separating 94 and fission products. Johns' group will be involved in 94 chemical

4/22/42

separation and the routine chemical control for metallurgy. Rundle must look into radiation effects and develop precautions for the radiation protection of workers.

We all had lunch at the Quadrangle Club—the University of Chicago faculty club. Since I will have the status of a visiting faculty member, I have decided to join this club. It is obviously an excellent place to have lunch because so many of the Metallurgical Laboratory people are members and frequent the place for lunch. Another convenient lunch spot is the Hutchinson Commons Room in the Student Union.

I opened the afternoon session with a discussion on the chemistry of element 94, reviewing first the possibility of an electrolytic separation of 94 from uranium and fission products, basing my remarks on our Berkeley experiments; we have indications that 94 is deposited on the cathode from aqueous solution much more easily when it is present in the oxidized state than when it is present in the reduced state—this forms the basis for a separation since the depositable elements can be removed when 94 is in the reduced state, after which 94 can be deposited more or less by itself when it is in the oxidized state. In connection with this discussion of electrolytic properties, I emphasized the importance of preparing 94 in the metallic form in order to determine its oxidation potential.

We discussed the possibility of a volatilization process for the separation of 94. I suggested studying the volatility of metallic 94 by bombarding uranium in the metallic form with deuterons and then heating in an inert atmosphere up to the melting point of uranium, about 1150°C , in order to ascertain whether or not metallic 94 can be volatilized. In connection with the possibility of removal of 94 from uranium and fission products by heating, I cited instances in which small amounts of radioactive substances have been removed in this way, for example, the volatilization of radioactive cadmium from deuteron-bombarded silver. I also proposed further investigation of the volatility of the oxides of 94, using higher temperatures and stronger oxidizing agents because the experiments at Berkeley so far have indicated that any higher oxide of 94, unlike its homologue osmium, is not volatile. I also mentioned the possibility of volatile fluorides and chlorides of 94. Urey emphasized

4/22/42

possible fluoride volatility methods, in which the uranium is removed as volatile uranium hexafluoride, which offers a method of separation from 94 whether or not 94 forms a volatile fluoride.

Precipitation methods were considered next. Perlman suggested the possibility of precipitating the 94 as the fluoride, with the aid of a rare-earth carrier, directly from the solution of uranium and fission products without an initial crystallization step to eliminate the bulk of the uranium. I suggested that, in addition to the insoluble fluoride, the possibility of an insoluble iodate, oxalate, etc., of the lower oxidation state of 94 be investigated. I also pointed out that the precipitation reactions of the higher oxidation state of 94 have not been investigated very much so far and that specific precipitating agents, such as organic reagents, are worth investigating.

The isolation of 94 by partition between two phases was discussed next, and it was agreed that partition between two liquid phases, with one phase being water, seems to offer good prospects for success. Solvents worth investigating appear to be diethyl ether, the chloro-ethers, the nitro-paraffins, methyl ethyl ketone, other ketones and diisopropyl ether. I pointed out that even down to concentrations of 10^{-12} M gallium chloride divides between diethyl ether and 6 N HCl in a ratio of 100 or 1000 to one in favor of the ether. The question was raised whether organic solvents might be destroyed by the intense radiation from fission products and Kennedy suggested the possibility of testing the effect of intense, heavily ionizing radiations by direct bombardment with the positive ion beam of the cyclotron.

Metallurgical methods were discussed by Spedding, one being the possibility of forcing oxygen through the molten metal in order to remove the oxides of 94 and some of the other elements in a slag; the possibility of selective 94 hydride formation and volatilization and selective chlorination was also discussed. The possibility of an adsorption method was considered, Boyd calling attention to the existence of new synthetic resins which pull ions out of solution, in contrast to previous materials which are able to remove only larger, organic molecules.

I outlined a procedure for isolating 94, which appears fairly certain of working in view of the experimental information obtained so

4/22/42

far. First, the bulk of the uranyl nitrate would be removed from the 94 by crystallizing it from aqueous solution as UNH. The 94 would then be isolated from the remaining uranium and other materials in solution by the method of precipitation from oxidizing and reducing media--the so-called oxidation-reduction cycle. First, the rare-earth and reduced 94 fluorides are precipitated together. The fluoride precipitate is then dissolved in sulfuric acid and, after addition of a strong oxidizing agent, the rare earth fluoride is again precipitated, carrying with it the fission products but leaving the 94 in solution in its higher oxidation state. Finally, the 94 is reduced to its lower oxidation state and precipitated as the fluoride. This oxidation-reduction cycle is based on our work at Berkeley and can be repeated to obtain additional separation of the 94 from fission products.

The afternoon session concluded with estimates being made of the number of men that might work on separations, and it was decided that in order to investigate all the methods a total of about forty investigators will be needed. It was agreed that the program should be augmented by investigations of the pure chemistry of 94, including experiments to determine the actual oxidation number of the oxidation states of 94.

Thursday, April 23, 1942

The Chemistry Conference concluded today, and I attended both the morning and afternoon sessions. Others present were Allison, Boyd, Johns, Kennedy, Perlman, Spedding, Szilard, Thiele, Urey, Wahl, Wheeler and Wilhelm. The morning meeting was primarily concerned with fission products. In order to aid in the discussion, Wheeler put on the board a complete chart of the fission products and of the relevant stable isotopes. The danger from the strongly radioactive gases produced was considered, it being suggested that a stack 200-300 feet high might be used to carry off the gases. It was decided it would be important to determine which of the elements in the region of the fission products have fairly long half-lives so that removal efforts can be concentrated on them rather than on the very long-lived or very short-lived isotopes.

4/23/42

It was estimated that about ten men will be needed for the fission product studies.

Boyd discussed the impurities in the intermediate pile and the gains to be realized by removing from the uranium and graphite gadolinium, boron, lithium, arsenic, chlorine and mercury, which have relatively large cross sections for neutron absorption. In connection with a discussion of thermochemistry and radiation, Spedding and I mentioned the advisability of more experiments on the physiological effects of radiation.

The concluding afternoon session was concerned with the testing of pile materials at room temperature and at high temperature, the radiation testing of the pile materials and of the chemicals used for extraction and isolation of the 94, the metallurgy of uranium and the need of the chemistry group for a top-rate theoretical chemist to make calculations of heat, radiation and gas liberation at each step of the various processes. The need to have a number of doctors and physiological chemists to look into the problem of protection from, and effects of, radiation on personnel was again emphasized.

From my standpoint, this two-day conference has not been very helpful, although it did give all of us an opportunity to learn about each other's program.

Also during the day I had a chance to discuss 94 extraction procedures with Tom Moore, a chemical engineer who is Eger Murphree's liaison man with Compton and to send Lyman J. Briggs (who is Director of the National Bureau of Standards and Chairman of the S-1 Uranium Committee) two recent reports dealing with the Berkeley work: "Slow Neutron Fission of U^{234} " by John W. Gofman and Seaborg, and "Szilard-Chalmers Process for Uranium" by David S. Breslow and John W. Hamaker.

I wrote to Helen just before I went to bed at about midnight.

Friday, April 24, 1942

I wrote James B. Conant (Chairman of the National Research Committee) in Washington about Gerhart Friedlander and how anxious I am to have him join our group, even though he will not receive his citizenship papers for about two months. Friedlander, born in Germany, worked closely with me at Berkeley for the last three years as a graduate student, and even before that as an undergraduate; moreover, he has been indirectly connected with the investigation of 94 since its discovery. I pointed out how urgent it is to employ him now and how indispensable he is if our work is to go ahead at a fast rate. I added that I am thoroughly convinced of Friedlander's trustworthiness and that I will gladly assume complete responsibility for him.

Other letters went to (1) Harrison Brown at Johns Hopkins, asking about his interest in joining our Chicago group; (2) the principal of the Alameda High School in California, requesting that he release Charles Blanchard from his teaching duties by May 15 so that he can join the Berkeley group full time for the summer, mentioning that we might bring him to Chicago instead, and saying that he would be working on a secret project of extreme urgency to the war effort; and (3) Kasimir Fajans of the Department of Chemistry, University of Michigan, asking if any of his students would like to join me here. I knew Brown as a brilliant undergraduate at Berkeley before he went on to obtain his Ph.D. degree at Hopkins. Blanchard was an effective part-time electronics man with my research group at Berkeley, and Fajans is one of the giants of the early days of investigation of natural radioactivity.

Spofford G. English arrived from Berkeley late this evening to join my group. He took up temporary quarters in the Mira-Mar Hotel. Spof is one of my graduate students and is co-author of our paper, "Search for Spontaneous Fission in 50-Year 94." He will be our expert on radiation counting and detection equipment and will immediately set up and put into operation the equipment that we arranged to have shipped here from Berkeley in order to insure an early start for our experimental program here in Chicago. He is a graduate student doing his research with me

4/24/42

with a year or so to go before he finishes the requirements for the Ph.D. degree; so he plans to spend the summer with us in Chicago and then return to Berkeley in the fall. There are two categories of scientists on the Project--Research Associates, who hold the Ph.D. degree or equivalent, and Research Assistants, holders of Bachelor's degrees. However, in view of his special background, English qualifies as a Research Associate.

Samuel Ruben, a chemistry instructor and my colleague at Berkeley, is in town for a few days, staying at the Mira-Mar Hotel, and I hope to spend some time with him. He and Martin Kamen discovered radioactive carbon (C^{14}) two years ago. Professor Wendell M. Latimer, Dean of the College of Chemistry at Berkeley and a good friend, also passed through Chicago today on his way to the annual meeting of the National Academy of Sciences in Washington, D.C.; I saw him only momentarily but expect to see more of him next Thursday when he passes through here on his way back home to Berkeley.

Scheduled to begin today at the Berkeley 60-inch cyclotron is the neutron bombardment of 210 pounds of $UO_2(NO_3)_2 \cdot 6H_2O$ (uranyl nitrate hexahydrate, which we refer to as UNH) for the production of 94^{239} . Martin Kamen has devised a special beryllium target for the 14-Mev deuteron beam. The target is almost completely surrounded by the uranyl nitrate; hence a good fraction of the neutrons will be absorbed. Irradiation will continue for two months and for a total of close to 50,000 microampere-hours, which should yield two or three hundred micrograms of 94^{239} .

I wrote a letter to Helen.

Saturday, April 25, 1942

English was placed on the payroll of the Metallurgical Laboratory this morning at a salary of \$225 per month.

4/26/42

According to Stearns' weekly report issued today, many new names were added to the Met Lab payroll list during the last two weeks. These include Allison, Arthur Snell, Louis Slotin and Wigner, as well as Perlman and me, who are all classified as Research Associates. In addition, Harold Lichtenberger, Gilbert Plass and John Plass were hired as Research Assistants.

M. D. Whitaker reports that the third exponential (so-called "intermediate") pile is now completed and a fourth is planned. ("Pile" is the colloquial Project name for the uranium chain reactor.) Also, the Columbia University pile is to be brought out here. Robert F. Christy and Eleanor Gish have estimated that the multiplication factor k is 0.94 for the first Chicago exponential pile and will be 0.96 for the third one, which is practically identical. Attainment of k -greater-than-unity is a prerequisite for a chain-reacting pile so this is a primary early goal for the Project using uranium-graphite so-called exponential piles. Measurements of these can be extrapolated to establish the value of k for an actual, operating pile.

Kennedy and Wahl left to return to Berkeley. They hope to visit Art's home in Iowa enroute.

My group has been allocated laboratory space on the top (fourth) floor of the Herbert A. Jones Laboratory, where barricades are being set up so our area can be isolated, with the help of a guard station at the entrance, from the normal University of Chicago Chemistry Department activities that are going on in the same building.

Sunday, April 26, 1942

I spent much of the morning reading the Chicago Sun (Marshall Field's newspaper). Today it includes much news on rationing and how it will be handled. The Sun appears to be a good newspaper, comparable with the San Francisco Chronicle, which I have been reading, and I will probably subscribe to the Sun.

Monday, April 27, 1942

Trying to recruit personnel for my group, I wrote to Darrell W. Osborne at the University of Wisconsin and Saul Winstein at UCLA, asking if they are interested in joining me; they were fellow chemistry majors at UCLA with outstanding scholastic records. I also wrote Lee DuBridge at the M.I.T. Radiation Laboratory for the names of any good men at the University of Rochester who might be interested in working on problems along the lines of artificial radioactivity and nuclear chemistry.

Our salary schedule here is the same as that at M.I.T. and Berkeley, set by the Office of Scientific Research and Development, I suppose to keep people from shifting about. A B.S. scientist without experience gets \$150 per month, and a Ph.D. gets \$100 more per month, plus \$25 per month for each additional year of experience. A faculty member who comes to us is offered a 20% boost in his university salary, plus a small cost-of-living allowance. So any inducement I offer to a potential member of my team must be largely on the merit of the job, and of course the true nature of the work cannot be divulged until after he is hired!

I wrote to Friedlander in Berkeley and asked him to send me a photograph or copy of the large wall chart of stable and radioactive isotopes that hangs in my office (Room 303) of Gilman Hall; also to send the samples of long-lived radioactive cesium that Margaret Melhase (one of my undergraduate research students) isolated from neutron-irradiated uranium, which we need for our investigations here. Another letter to Berkeley went to Professor Gilbert N. Lewis, who preceded Latimer as Dean of the College of Chemistry, whom I requested to write to Conant on Friedlander's behalf. I served as Lewis' personal research assistant for the two years immediately following receipt of my Ph.D. degree.

I wrote to Helen in the evening.

Tuesday, April 28, 1942

I dictated to Mrs. Sullivan some of the first draft of the complete report "Properties of U²³³" by G. T. Seaborg, J. W. Gofman and R. W. Stoughton. This will describe in detail our work at Berkeley on the discovery and determination of the slow neutron fissionability of U²³³.

Our chemists here will need a good supply of uranyl nitrate hexahydrate (UNH), and I informed Hilberry that while I was at Berkeley we found the best source to be that of the Shattuck Company in Denver--inexpensive and of high purity (four times recrystallized). He agreed to place an order for 600 pounds for the use of the chemists on the Project.

Perlman and English have spent most of their time while here discussing their research with me, acquiring chemicals, reagents, glassware, balances, assembling our counting equipment, and all kinds of other paraphernalia, and in general, preparing to put the show on the road. We have a good supply of the alpha-emitting 94 isotope with 50 years half-life, about 3 million disintegrations per minute, which has been shipped here from Berkeley, so we are ready to start our experiments immediately. This isotope, produced by the bombardment of natural uranium with deuterons (energy slightly less than 16 Mev) in the Berkeley 60-inch cyclotron, is the first isotope of element 94 to be discovered; it has not been assigned a mass number yet with the choice lying among 238, 235 and 236. This alpha-particle-emitting isotope was used by us at Berkeley for the study of the chemical properties of 94 by the tracer method and this will be its use here at Chicago. The particular bombardment in which this supply of tracer was produced earlier this month in Berkeley has the designation U-D,2; it was prepared by English in Berkeley and the solution has a content of 50-year 94 corresponding to about 30,000 alpha-particle counts per minute per cc or about 60,000 alpha-particle disintegrations per minute per cc.

This evening I listened to President Roosevelt's fireside chat on

4/28/42

the radio; he set forth a seven-point program of general principles for a national economic policy designed to keep down the cost of living.

Wednesday, April 29, 1942

This morning the Chicago Sun reports President Roosevelt as saying last night that the war effort "must not be impeded by the faint of heart" and "it must not be impeded by those who put their own selfish interests above the interests of the nation" and that the people in our country must make sacrifices. Included is a complete list of price control orders, including rents.

We have moved into Herbert A. Jones Laboratory (Figure 4), one of the two chemistry buildings (the other is Kent Laboratory where Boyd's Project work is housed) on the campus which are in the same row of buildings as the physics buildings, Eckhart Hall and Ryerson Laboratory. We are on the fourth floor and will occupy Rooms 401, 402, 403, 404 and 405 (Figure 5). Room 402 (designed for use as a two-man private research lab) will be converted to serve as our counting room to house our alpha, beta and fission counters, etc. I will share Room 403 (built to serve as a room for high temperature chemistry) with Spedding as an office; the room will be divided into two parts by a partition. (Mrs. Sullivan will remain in Eckhart Hall and maintain my files there until I find it convenient to find another secretary and move all of my activities, including correspondence, phone calls, etc., to Jones Laboratory.) Room 404, a large room with several fume hoods and five long laboratory benches with sinks, is capable of accommodating a substantial number of chemists; it was designed to serve as an inorganic preparation room and will serve our purposes admirably. Room 405 is a little dark room capable of being converted into a special purpose laboratory. Room 401, like Room 402, also was designed for use as a two-man private research laboratory; it is equipped with fume hoods and we will use it as a general purpose laboratory.

Our initial supply of counting equipment has been shipped from Berkeley. In Room 402 we will set up our alpha-particle and fission

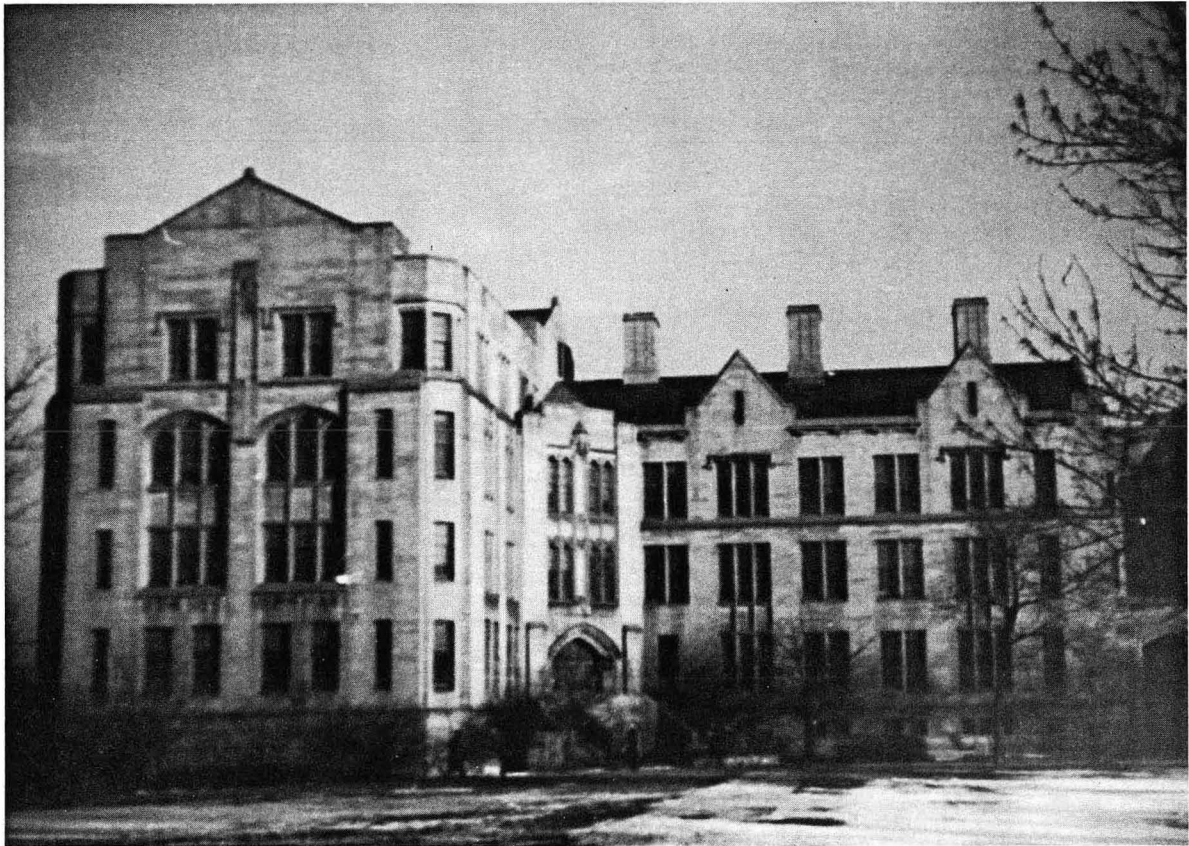

Fig. 4 Herbert A. Jones Laboratory. Our laboratory space on top (fourth floor) of wing at left. Roof top work area at right end of right wing. (XBB 768-7453)

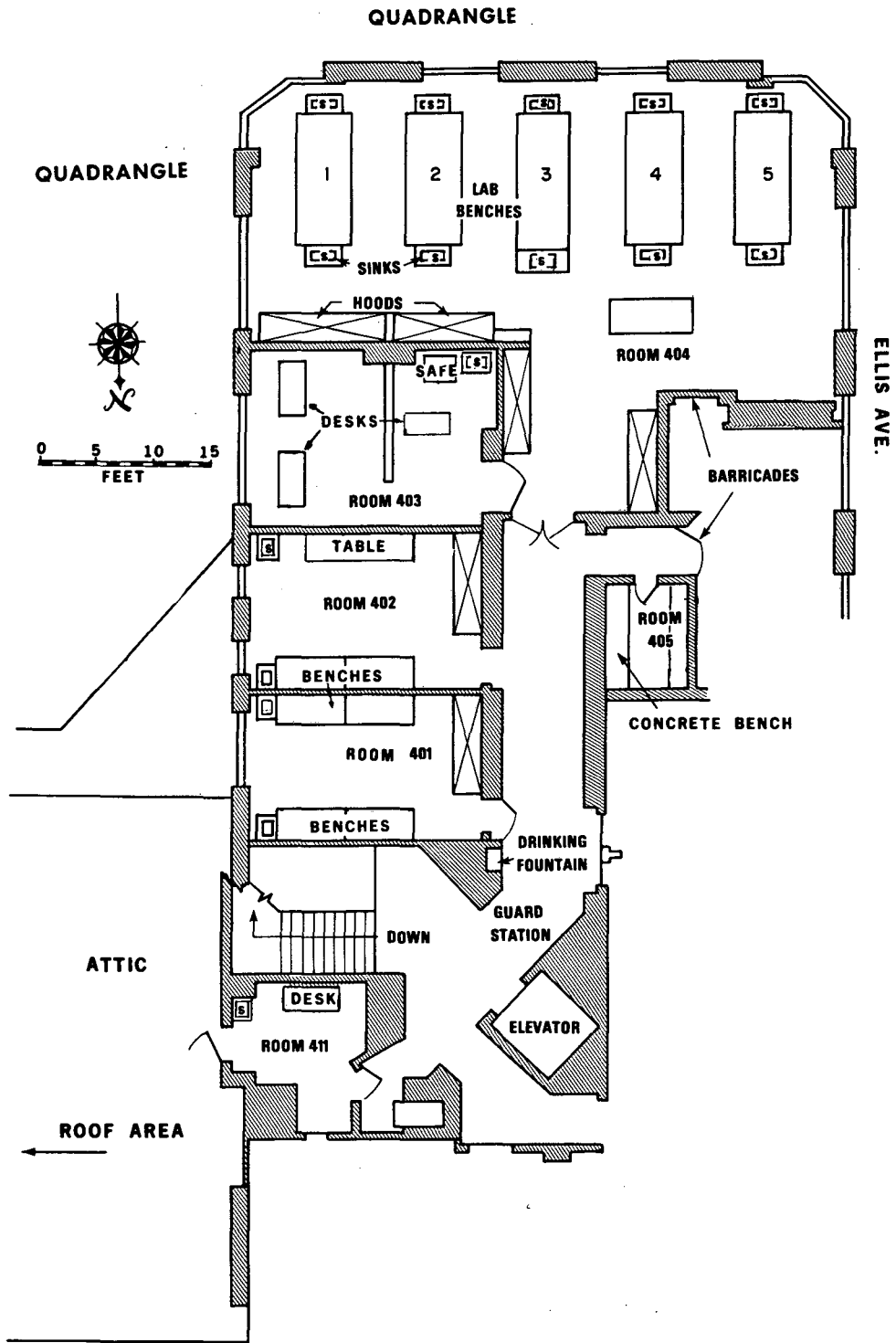

Fig. 5 Floor plan of space occupied by our group on fourth floor of Jones Laboratory (as it developed during our first few months of occupancy.) (XBL 758-3804)

4/29/42

counting ionization chambers, our beta-particle counters and attendant amplification and recording equipment, as well as our electroscopes. We will have a screened window alpha-counting ionization chamber which will be equipped with a magnet for bending out high intensity beta particles that might be present in the alpha-particle-emitting samples; this can also be used as a "low geometry" alpha particle detector, with or without intervening screens, with the magnetic field off. For the measurement of alpha-emitting samples of intermediate density, we will have an ionization chamber with an arrangement to have the samples placed nearer the screened window; this setup also has provision for interposing additional screens between sample and ionization chamber to allow measurement of samples of higher intensity. In addition, for determining the absolute counting rate of alpha-particle-emitting samples we will have an ionization chamber of the "inside" type in which the sample is placed on one electrode inside the ionization chamber; the geometrical efficiency of this has been determined in experiments at Berkeley to be approximately 45% by counting the alpha particles of a weighed uranium sample (200 micrograms) placed in the identical position. We will have a numbering system for our alpha particle counters in which the first will be designated BC-1, the second BC-2, etc.; this is based on a numbering system we had at Berkeley, B-1, B-2, etc., with the addition of C to stand for Chicago. A special variation of the "inside" chamber will be used for our fission measurements using Ra-Be neutron sources.

For the counting of beta-particles and gamma-rays we will use Geiger-Müller counters and Lauritsen quartz-fiber electroscopes of the type we used at Berkeley. Our calibrated (30% counting efficiency) Geiger-Müller counters are of the bell jar type, about 5 cm long and 3 cm in diameter, with a central wire extending down to within a few mm of a thin mica window at the bottom end; below the window is a sample holder arrangement consisting of a number of slots at increasing distances to allow radiation absorbers to be placed between the sample and the window when the sample is placed in a lower slot. For our Geiger-Müller counters we will use a numbering system ZC-1, ZC-2, etc., based on the numbering system we used in Berkeley (Z-1, Z-2, etc.) with the introduction of C to stand for Chicago. The cylindrical outside

4/29/42

container of the air-filled Lauritsen quartz-fiber electroscope is made of aluminum with a window of thickness about 3 mg/cm^2 at the bottom for the entrance of the radiations from the sample; we add a sample holder arrangement consisting of a number of slots at increasing distances from the window to allow the interposition of radiation absorbers when the sample is placed in a lower slot. The rate of discharge is measured in terms of the rate of movement of the quartz fiber so the intensity of radioactive samples is recorded in terms of "divisions per second." For our electroscopes we will use the numbering system EC-1, EC-2, etc. We also plan to reproduce our Berkeley apparatus consisting of an ionization chamber (air-filled or freon-filled) connected to a General Electric FP-54 vacuum tube amplifier (electrometer) and galvanometer with resistance and shunt arrangements to vary the sensitivity of the galvanometer reading over a wide range.

The space is more than adequate for the time being, but I hope to have about twenty people in my group before long, and then we will fill it to capacity and even be too crowded.

We are setting up the labs with what meager equipment we have on hand; considerably more is on order. Some of the University lab classes meet in this building, but we are rather isolated on the top floor; and as for protecting ourselves from anyone who might wander in, we have barricades setting off our suite of rooms and will soon have guards stationed at the entrance to our area. We can come up to the fourth floor either by elevator or by a rather ornate winding staircase. Like everyone else on the Project, it is a daily ritual for us to wear badges to identify ourselves.

Harrison Brown wrote; he is interested in my offer of a job and is willing to come to Chicago if necessary to talk things over. His contract as an instructor of chemistry at Johns Hopkins expires June 30.

I sent a telegram to Helen in California asking her to send me the original carbons of my 1/28/41 and 3/7/41 letters to Philip H. Abelson and Lyman J. Briggs announcing the discovery of element 94, which I need to give to Gregory Breit here at the Met Lab to hold for post-war publication in the Physical Review.

4/29/42

The weather has been quite hot during the week, has hovered around 85° most of today and yesterday. Tonight in my warm hotel room I wrote to Helen complaining that I have received only four letters from her.

Thursday, April 30, 1942

The first thing I did this morning was to move my office from Eckhart Hall to Room 403, Jones Laboratory; Mrs. Sullivan, although still handling my secretarial needs, is remaining in Eckhart Hall.

Perlman also has moved into the new facilities; he plans to do his work in the large Room 404 and also to share my office. He immediately began to synthesize UF_4 , incorporating 50-year 94 tracer, using UNH (uranyl nitrate hexahydrate) for a starting material. The UF_4 will be used in the 94 volatility experiment which Harrison Brown will perform at Johns Hopkins University. This is one of the chemical investigations on 94 that I proposed in my letter to Compton, March 31, a suggestion made by Urey in a letter to Lawrence last January. The idea is that after element 94 is made in the pile the mixture of 94, uranium and fission products could be treated with fluorine so that UF_6 would be formed. If the fluoride of 94 is found to be volatile, then it and the uranium hexafluoride can be separated from the fission products and later separated from each other. And if it is not a volatile substance, then a method would be provided for separating the uranium from the mixture of 94 and fission products. Brown's task will be to fluorinate a sample of Perlman's UF_4 (prepared by precipitation) which contains a tracer amount of 50-year 94, after which the volatile UF_6 and non-volatile residue will be returned to us to determine the disposition of 94 tracer in the experiment.

English has also moved into Jones Laboratory. He will divide his time between Room 404, for his chemistry experiments, and Room 402, where he will supervise the counting experiment.

Norman Bonner sent me from Berkeley his final report, dated April 25, 1942, for the undergraduate chemistry courses 180H and 199 taken

4/30/42

under my direction at the University, entitled "Precipitation of UX_1 from Solutions Containing Large Amounts of Uranium." This paper describes his work done at Berkeley during January-April 1942 in collaboration with Isadore Perlman, Beppino J. Fontana, René J. Prestwood and Charles Auerbach on the isolation of high intensity samples of UX_1 for the preparation of U^{234} .

I received an invitation to be a dinner guest, along with other speakers, at the annual meeting of the New York Section of the ACS (American Chemical Society) on Friday, May 8, where I am scheduled to speak; I accepted the invitation for this speaking engagement before I left Berkeley to move to Chicago.

Professor Wendell M. Latimer, on his way home to Berkeley from Washington, visited the Project today, and he and I met with Compton (preceded by a meeting between Compton and me alone) to discuss a contract, with Latimer as Principal Investigator, to continue the 94 work I began and supervised in the Berkeley Department of Chemistry. Compton agreed on Latimer's role and thought it could be worked out with Ernest O. Lawrence, Director of the Radiation Laboratory at Berkeley. Compton also told me that he wants to continue to use the 45-inch cyclotron at Washington University, St. Louis, to produce samples of 94 for our work here, just as we have been doing in Berkeley, and he has initiated the request. Targets of uranium metal will be bombarded with deuterons to give 50-year 94, and hundreds of pounds of UNH will be exposed to neutrons to produce experimental quantities of the longer-lived 94^{239} . I have the rather far-out idea that perhaps we can produce and isolate sufficient 94^{239} in cyclotron bombardments to make it possible to work with element 94 in the pure state on the ultramicrochemical scale. Alexander Langsdorf and Harry W. Fulbright are in charge of the cyclotron at St. Louis.

Later, Latimer and I talked about some of the more promising students in the Chemistry Department at Berkeley who might be induced to come to Chicago to work for me. In particular, there are Ralph A. James and William J. Knox who will get their B.S. degrees next month. Another person we discussed was Daniel E. Koshland, Jr., who received his B.S.

4/30/42

from Berkeley last year and is now working for Shell Development Company in Emeryville, California. Latimer remarked that Koshland was in the top two percent of his class and held, during his senior year, the prestigious James Monroe McDonald Scholarship. He said he would get in touch with all three. He mentioned that his Chemistry Department will have a new batch of 16 Ph.D.'s next month, among them Wahl and Friedlander who both did their Ph.D. work under my direction. My aim is to get Friedlander here as soon as this business about his security clearance is resolved.

After Latimer took leave I addressed letters to Briggs in Washington and Brown in Baltimore, telling of my plans to visit them on May 6, morning and afternoon, respectively. I decided to take advantage of my planned visit to New York City to visit them in Washington and Baltimore enroute. I had numerous contacts with Briggs, in his capacity as Chairman of the U.S. Uranium Committee (the S-1 Committee), in connection with my research program on element 94 and other heavy elements at Berkeley. My interest in seeing Brown, of course, is to discuss plans for joining my group in Chicago and for the joint fluorination experiment that we have under way.

Tonight I attended and spoke at the regular Thursday evening Project Seminar for Research Associates. This is an interdisciplinary seminar in which current research plans and progress are discussed; several speakers are scheduled for each meeting. I gave a summary of the research we have performed at Berkeley.

When I returned to my hotel I found a nice long letter from Helen. I wrote her a long letter in return, including an apology for my impatient letter of yesterday.

MAY 1942

Friday, May 1, 1942

I went to the Chicago and Northwestern Railroad Station on Canal Street to meet Joseph G. Hamilton, who arrived at 9:30 a.m. from Berkeley on the City of San Francisco. We took part in a luncheon meeting at the Quadrangle Club with Compton and others, and Joe had a chance to discuss his own program. He is director of biomedical research in Lawrence's program in Berkeley, and as an M.D., he is interested in the ingestion of radioactive isotopes and their uptake in organs. He was the first to use radioiodine as a diagnostic tool in thyroid disorders. Joe and I discussed the proposed contract with the Berkeley Chemistry Department, and his reaction to it was favorable. Joe is in charge of the 60-inch cyclotron at Berkeley which will continue to be used by the Berkeley group and also by my Metallurgical Laboratory chemistry section for some of our experiments. We also talked about Compton's plan to use the Washington University cyclotron, and he agreed to visit St. Louis and see what changes need to be made to achieve maximum efficiency.

I received an April 29 letter from Friedlander saying a photographer has been called in to photograph the isotope chart in Room 303 of Gilman Hall and that I will receive the negatives.

I received from Berkeley the original carbons of my 1/28/41 and 3/7/41 letters to Abelson and Briggs announcing the discovery of element 94 and took the relevant excerpts around to Gregory Breit to hold for post-war publication. (Breit is coordinator of the Project's basic experiments on fast neutron reactions at several universities.) I also spoke to him about getting our letter of May 29, 1941, to Briggs announcing the discovery and measurement of fissionability of 94^{239} into

5/1/42

official custody for eventual publication in the Physical Review*; he assured me he would try to arrange it.

I made a long distance phone call to Berkeley and talked to Kamen about our 60-inch cyclotron bombardment schedule. I also spoke to Helen, and later I sent her a telegram apologizing for my complaining letter of Wednesday which she should receive about as soon as she receives the letter.

While I was writing to Helen in my hotel room in the evening, I was interrupted by another phone call from Kamen, who had further questions about our cyclotron bombardments.

Saturday, May 2, 1942

Perlman completed his preparation of the UF_4 sample incorporating 50-year 94. It weighs 7.2 grams and contains an amount of 94 corresponding to an estimated 20,000 alpha counts per minute, but this needs be determined by actual measurement. He divided the sample into two halves--3.6 grams in each. I will ask Brown to fluorinate one of these samples, even though we have not yet completed arrangements for his joining my group. I plan to deliver the sample to him in Baltimore next Tuesday, after my session with Briggs and others in Washington, and then go on to New York.

I heard from Stearns' office that Elwin Covey has accepted our job offer. I wrote to him urging that he join us as soon as possible.

*The January 28, 1941, report, "Radioactivity of Element 94 from Deuterons on Uranium," by G. T. Seaborg, E. M. McMillan, J. W. Kennedy and A. C. Wahl, was eventually published in Physical Review, 69, 366 (1946); the March 7, 1941, report, "A New Element: Radioactive Element 94 from Deuterons on Uranium," by G. T. Seaborg, A. C. Wahl and J. W. Kennedy, was eventually published in Physical Review, 69, 367 (1946); the May 29, 1941, report "Properties of 94(239)," by J. W. Kennedy, G. T. Seaborg, E. Segrè and A. C. Wahl, was eventually published in Physical Review, 70, 555 (1946).

5/2/42

The Met Lab now has 153 employees, half of whom are Research Associates and Research Assistants. Because of the manpower shortage, there are also 20 high school boys. There are 50 persons working on exponential, or intermediate, piles in the West Stands Laboratory, including Walter H. Zinn and Enrico Fermi who just arrived last month from Columbia University in New York. The Columbia intermediate pile is being shipped here, and the graphite and uranium oxide will be used in the construction of future piles.

The Project Planning Board met today, attended by Allison, Compton, Doan, Fermi, Hilberry, Moore, Spedding, Szilard, Thiele, Wheeler and Wigner. Moore reported on the problem of finding a site for the production pile and for the chemical extraction plant. Because of electric power and water supply the most promising so far seem to be the Grand Coulee area in the State of Washington and Tennessee Valley between Watts Bar and Norris Dam. A site on the Clinch River in Tennessee was discussed, which has the advantage of a nearby railroad. Many comments were made about the size of the power plant, the heat exchanger, the chemical extraction plants, laboratory location and waste disposal. Fermi expressed doubt that water could be used as a cooling agent because of its effect on the chain reaction. Compton stressed the urgency of choosing a site, because operation of the pilot plant is scheduled to start by January 1 of next year; he will send two men from the Laboratory to investigate.

A discussion of the value of k , the multiplication factor, followed. Christy's latest calculations give 0.95. Wigner and Fermi anticipate a gain of 0.12 by the removal of hydrogen, nitrogen and other impurities, improvement in geometry, the use of uranium metal instead of oxide, bringing the value to 1.07. Compton estimated that this value corresponds to a pile having a volume equal to that of a 17-foot diameter sphere.

Sunday, May 3, 1942

Under a New Delhi dateline in this morning's Sun, I read the headline "Mandalay's Defenses Crumble." Speculation is that the fall of Burma is imminent.

Monday, May 4, 1942

Coryell arrived today to start work at the Met Lab as head of the group working on the chemistry of fission products. He has left his position as Instructor of Chemistry at UCLA; I knew him there and also when he was a graduate student at Caltech. His laboratory space will be in Kent Chemical Laboratory, the chemical laboratory building adjoining Jones Laboratory, and will be centered in the large student chemistry laboratory, Room 303. He will stay at the Mira-Mar Hotel until he is joined by his wife Gracemary.

I continue to be greatly concerned about recruitment, and in today's mail there were some interesting letters. Darrell Osborne is doing some research for Tennessee Valley Authority at the University of Wisconsin; he wants to continue his teaching there because he feels that the training of chemists is of paramount importance. DuBridge wrote that when he read my letter of April 27 he had to suppress a smile. All the University of Rochester men that I inquired about are at work on defense projects there or else have been pulled away to other projects. He went on to say—which probably sums up the job situation for the U.S. at large—"The country has been pretty well surveyed I believe for men trained in nuclear physics; and you will, no doubt, have difficulty finding anyone except graduate students who have not completed their work, but who might be interested in discontinuing it for the duration of the war in order to get into a war problem." Pretty gloomy!

But there were some bright rays. Forwarded from Berkeley was a letter from my friend Paul Saunders whom I knew at Berkeley during his undergraduate days as a chemistry major; now at Caltech, he said that although he is only four months away from the completion of his Ph.D.

5/4/42

thesis, he would like to consider an offer of employment from me. There was also a telegram from Melvin Calvin in Berkeley asking if I could use Sam Aranoff. Aranoff is an exceptionally able chemist who will be getting his Ph.D. in biochemistry this month.

Most of the day was spent in completing the dictation of the report on "Properties of U^{233} " that I started last Tuesday.

John W. Hamaker, another of my graduate students in the Berkeley group, specializing in microchemistry, sent me a short progress report of his work. He also enclosed a list of the microchemical equipment he has ordered in Berkeley, which he prepared at my behest.

Compton's message got through to the cyclotron people at Washington University, and they say they are set up and ready to take element 94 production orders from us. Hamilton arrived and gave them instructions as to the changes that will be necessary to give the desired irradiations with the maximum efficiency.

The University of Chicago Chemistry Department holds weekly seminars on Monday afternoons, and I talked there today. I talked on artificial radioactivity and the use of tracers but managed to cover only half the ground I had planned. As a consequence, they invited me to come back and finish my talk next Monday afternoon. During the coffee session before the talk I met or renewed acquaintance with many of the faculty of the Chemistry Department—Herman Schlesinger, James Franck, Warren Johnson, Thorfin Hogness, Fraser Young, William Harkins and Herbert Brown. Harkins described to me his early work in nuclear science and indicated that on the basis of this he should probably have at least shared credit for the discovery of the neutron. I also met some of the younger men, graduate students and men working on Schlesinger's secret projects (the synthesis of volatile compounds of uranium that might substitute for uranium hex-fluoride, etc.), including Joe Katz, Arthur Bond, Henry Hoekstra and James Gilbreath.

Tonight I wrote to Helen again.

Tuesday, May 5, 1942

Perlman's wife Lee and 1-1/2 year old daughter Judy arrived today by train from Los Angeles; so Iz won't be staying at the Mira-Mar any more. He has found an apartment on Drexel Boulevard quite close to Jones Laboratory.

Milton B. Burton, from New York University, visited the Met Lab today, at Spedding's invitation, to investigate his possible interest in joining the Chemistry Division to be in charge of a group studying the effects of radiation on pile and chemical extraction materials. Burton is an expert in photochemistry and well qualified to take on this task. I was delighted to see him this morning and recalled with him his sabbatical year at Berkeley about five years ago when we became well acquainted. In fact, we carried on collaborative research, at a distance, on the applications of radioactive tracers to a photochemical problem during the intervening years.

The time has now come to get approval for continuation of my Berkeley program for the next six months, starting July 1. I sent Latimer a summary of the proposed budget and projects and suggested that he show it to Lawrence after making any desired changes, with the suggestion that this program be carried out in the Chemistry Department and be under direct contract with the Metallurgical Project rather than as part of the unrelated Lawrence electromagnetic isotope separation project.

In the summary, I divided the program into three projects. No. 1 concerns the further investigation of the fission properties of U^{233} and methods of separating it from large amounts of thorium. I stated that U^{233} may be superior to 94^{239} for three reasons: it might have a lower spontaneous fission rate, more secondary neutrons from fission might be liberated and its chemical isolation might be easier, since its chemical properties are known with certainty and since there would not be the large amount of extremely radioactive fission products to complicate the chemical procedure. No. 2 calls for further investigation of the chemical properties of elements 93 and 94, as well as a search for elements

5/5/42

93 and 94 in nature. Lastly, No. 3 relates to the preparation of U^{234} and measurement of its fission properties.

For project No. 1, I suggested Stoughton and Gofman; for No. 2, Morris Perlman, Friedlander or substitute, Gofman, R. B. Duffield and Hamaker; and for No. 3, Beppino J. Fontana, Glenn E. Sheline, René J. Prestwood and Ned R. Reed or Oscar A. Cook. In addition there will be laboratory helpers Gayle E. Adams and A. Tanzillo and laboratory technician Stanley T. Abrams, plus a shop man and clerical help. The proposed salary budget for the six months comes to \$16,000. Expenses for running the project, including equipment, salary overhead and cyclotron time to produce U^{233} and 50-year 94 brings the total proposed budget to \$44,000. I believe this program will be approved by the authorities in Washington, and I hope that Compton and Lawrence will agree to this method of funding it.

I prepared a letter to Gofman to be used in transmitting the rough draft of the write-up on U^{233} as soon as Mrs. Sullivan types it. I asked that Stoughton as the other co-author have a look at it too. In my talks with Halban he convinced me that we should be bombarding solid thorium nitrate rather than the saturated solution that we used last time. I asked Gofman to convey this information to Stoughton, who should prepare a solid thorium nitrate sample of about 75 pounds and use the same geometrical arrangement employed by Kamen, Wahl and Kennedy in the big neutron bombardment of uranium that is under way to produce experimental quantities of 94^{239} .

I acknowledged the April 28 letter from Saunders and yesterday's telegram from Calvin. I told Saunders I would like very much to have him in my group, to let me know his decision as soon as possible, and that he will be granted draft deferment if he accepts a position. I told Calvin that I am interested in Aranoff but don't think we have things in shape to handle many more men at present because there is still the question of space and because major equipment must still arrive.

I dropped into Breit's office and inquired further about getting the letter of May 29, 1941, into official custody for its eventual

5/5/42

publication in the Physical Review (the same request I made of him last Friday) and he told me that arrangements are being made.

At 4:30 p.m. I boarded the Capitol Limited for Washington, D.C., and wrote to Helen enroute.

Wednesday, May 6, 1942

At 8:40 a.m. I arrived in Washington and took a cab to the National Bureau of Standards, where I met with Briggs and H. T. Wensel, Technical Aide, OSRD Uranium Section S-1, to discuss my work in Berkeley on the Uranium project.

After lunch in downtown Washington, I took the one o'clock train to Baltimore, where I visited Harrison Brown, Robert D. Fowler and others at the Johns Hopkins University Chemistry Department. I gave Brown the 3.6-gram sample of UF_4 incorporating the 50-year 94 tracer, and I asked him to fluorinate it and return both the product and residue to me in Chicago. It was arranged that he will join my group at the Met Lab about June 1, and I suggested that he send me diagrams of his fluorine generator so we can get our shops started on fabricating one as quickly as possible.

The evening train brought me to Jersey City, where I crossed the Hudson River via ferry on a bus and arrived at Grand Central Station at about 10:15 p.m., then checked into the nearby Commodore Hotel. The neon lights in the city have been dimmed, a sharp contrast to the bright lights I saw here during my visit last August. I again wrote to Helen while enroute on the train.

Thursday, May 7, 1942

After breakfasting at the Commodore Hotel I rode a cab to Columbia University. John R. Dunning and I conferred about our talks to be given

5/7/42

at the ACS meeting tomorrow. We then got together with Eugene T. Booth, Aristid V. Grosse and others and talked about their research programs. It was Dunning, with his colleagues Booth and Grosse, who first confirmed, using a sample of U^{235} isolated by Alfred O. C. Nier in his mass spectrograph, that it is this isotope of natural uranium that fissions under slow-neutron bombardment. We all had lunch at the Faculty Club where I saw my Berkeley friends Bill Libby, Earl Long and Phil Schutz. I then visited the University labs and saw Harold C. Urey and his research program. Urey is a member of the S-1 Section—the OSRD Section on Uranium—and heads the program to separate U^{235} by gaseous diffusion methods.

Around four o'clock I returned to the hotel for a conference with Thon about the "Annual Tables," for which I am scheduled to provide a "Table of Isotopes," and arranged to send him a copy of my planned Review of Modern Physics "Table of Isotopes" when it is ready. After this I went out and rented a tuxedo plus accessories for tomorrow night (at a cost of \$5).

Perlman called me at the hotel from the Met Lab to bring me up to date. The uranium metal targets that were sent to Washington University to determine the yield of 50-year 94 were bombarded with 12 Mev deuterons for a total of 500 microampere-hours yesterday and the day before. Next we will set up to irradiate large quantities of UNH with neutrons from their cyclotron to produce 94^{239} in as large a quantity as possible.

I dropped by the Picadilly Circus Bar and heard "The Three Suns" and had dinner at a grill on Broadway. It was a lonely evening, and I was happy to return to my hotel and write to Helen.

Friday, May 8, 1942

The peregrinator Joe Hamilton is in New York, and over breakfast at

5/7/42

my hotel this morning we talked about his trip to Canada, his recent St. Louis visit and other matters. We parted briefly while I took a cab to the offices of the Standard Oil Development Company of New Jersey at 26 Broadway, where I had an 11:00 appointment with Eger V. Murphree, a chemical engineer and their director of research. He is Chief of the Planning Board of chemical engineers of the S-1 Committee and also heads the group to investigate U^{235} separation by centrifuge methods. In his capacity on the Planning Board Murphree has an interest in the 94 separations problem. He visited me in Berkeley the first week of April, and I was able then to show him something of the chemical program we had under way. In particular, we discussed the possibility of isolating 94 from uranium and fission products by the methods of crystallization and electrolysis. We spent a pleasant but intense half hour exchanging ideas about the chemical extraction of 94. According to Compton's timetable, not only must a chain reaction be produced by the end of this year, but by the end of next year a pilot plant to manufacture 94 must be operating and quantities of 94 extracted from its uranium. Murphree is the true go-getter type; if the Project falls behind in schedule, it will not be from his lack of dedication or enthusiasm.

From here I taxied to the Faculty Club at Columbia University, where Joe and Dunning and I had lunch with our many friends and acquaintances. Later in the afternoon Joe and I taxied back to the Commodore Hotel, were joined later in my room by Dunning, and Dunning and I donned our tuxedos for tonight's performance--our talks at the ACS meeting. Joe, John and I took a cab to the Hotel Pennsylvania with lantern slides in hand and were greeted by a bulletin board poster announcing the annual meeting of the American Chemical Society, New York Section, Inc. Displayed in bold letters was the quaint but provocative invitation, "Ladies Are Welcome." Dunning and I, as the two speakers of the evening, were treated to dinner with members of the New York ACS Section in the hotel's Cafe Rouge; Charles Spivak's orchestra entertained with dinner music. Then at eight o'clock we rode up to the Salle Moderne on the 18th floor where the actual meeting was held.

I was the first on the program, and after a brief introduction by Ralph H. Muller, the Chairman, I addressed my audience on the topic,

5/8/42

"Applications of Artificial Radioactivity to Chemistry, Biology and Medicine." My talk opened with a description of the discovery of artificial radioactivity by the Curie-Joliot in 1934, just eight years ago, and I went on to review the types of artificial radioactivity now known and stated that there are 370 species of artificial radioactivities, produced in about 700 different nuclear reactions. I discussed the application of these isotopes to the study of exchange reactions and reaction mechanisms, including uses in analytical chemistry. I spoke of those elements not found in nature, elements 43 and 85, but needless to say, did not dare touch on the transuranium elements. I also reviewed some carbon-11 experiments, especially those dealing with the mechanism of photosynthesis. In conclusion, I described applications of radioactive isotopes to biology and medicine, including an explanation of how radio-autography is used in biology and medicine.

Dunning was next on the podium and he gave a lively demonstration-lecture entitled, "Production and Detection of Radioactive Isotopes." He demonstrated the use of counters, ionization chambers and photographic emulsions and followed through a typical isotopic tracer technique. A. Benedetti-Pichler from the Department of Chemistry, Queens College, Flushing, New York, was in the audience. We had a chat and agreed to get together for a longer talk tomorrow in my hotel. I have previously communicated with him because he is one of the pioneers of ultramicro-chemistry and can be of great help to me.

In the course of the evening I had a chance to talk with Milton Burton and to urge him to join us at the Met Lab. He indicated that he has decided to do so. I also saw and talked with many other friends, including Victor La Mer, Earl Long, Bill Libby, A. V. Grosse and Phil Schutz.

After the meeting Dunning, Joe, Libby, Grosse, Long and I went to "Jimmy Kelley's" in Greenwich Village and to the "Cafe Society Downtown," featuring Teddy Wilson's orchestra. I returned to the Commodore Hotel and fell into bed at 4:00 a.m. It was an exhausting day.

Saturday, May 9, 1942

My visitor, Benedetti-Pichler, arrived at 11:00 this morning. We talked until noon, then continued over lunch at the hotel. Although I could not describe to him the particular project I have in mind, I told him I hope to enter his field of ultramicrochemistry. He promised to send me a list of the most essential equipment required for my venture into the ultramicroscale world of chemistry. In order to pursue the chemical study of pure 94 with the minute amounts that can be produced in cyclotron bombardments, it will be necessary to work with volumes of solutions of the order of 10^{-5} to 10^{-1} milliliter to correspond to quantities of 94 in the range of a few micrograms; it will also be necessary to handle precipitates in this range. We also discussed the highly-qualified Michael Cefola, a former student of Benedetti-Pichler, who is on the staff of the Department of Chemistry at New York University, and I decided to make Dr. Cefola an offer to join us in Chicago. He will be an asset in setting up ultramicrochemical equipment and using it for our investigations. I still believe it is feasible to study the chemical properties of pure 94 produced in cyclotron bombardments; all the chemical investigations so far have been conducted on the tracer scale.

To my delight, I have received three letters from Helen during my stay in New York. I wrote to her this afternoon in an exuberant mood.

I had dinner at the Mexican Xochitl Restaurant on 46th Street near Broadway with the Libbys and the Schutzes; later I went to the Grand Central Station and at 10:00 p.m. boarded the New York Central train to Chicago which left at 11:30 p.m. It will take me back to Chicago with arrival scheduled at 4:00 tomorrow afternoon.

Sunday, May 10, 1942

Enroute to Chicago, I had breakfast and lunch in the diner, spent the remainder of the time reading newspapers which are filled with

5/10/42

descriptions of our victory over the Japanese in the "Battle of the Coral Sea." I also heard over the radio in the lounge car the inspiring speech by Winston Churchill which was scheduled for this afternoon. I again wrote to Helen. We arrived in Chicago at 4:00 p.m. on schedule, and I went immediately to Jones Laboratory to check my mail, found several letters from Helen, which prompted me to write her again.

Monday, May 11, 1942

When I returned to my office in Jones Laboratory this morning I found a letter from Paul L. Kirk, an associate professor of biochemistry at Berkeley. It was in reply to my inquiry about a microchemist who might be available for my program. He endorses Burris B. Cunningham highly; Cunningham has a Ph.D. in biochemistry and is especially skilled in ultramicrochemistry. He said he would be reluctant to see him go because he is counting on him as a key man in a program he is trying to organize in Berkeley. Another complication is that the two of them are working intensively on a general reference book on microchemistry. Kirk, however, has not been successful yet in getting a war project; so Cunningham may be available. He mentioned that he himself might come if I really need him.

Also, there was a response from Professor Fajans at the University of Michigan to my letter of April 24. He said that none of his students is available for positions here, that Amos Newton is with Eastman Kodak, Adolf Voigt is teaching at Smith College, and Johnson is doing chemical work for the cyclotron physicists. He did suggest one prospect, however, Bertrand L. Goldschmidt, who came to the U.S. about a year ago and is living in New York City; formerly he was associated with the Curie Laboratory in Paris. Unfortunately for my purposes he is a French citizen; but like Friedlander, who is also an alien, he is worth pursuing.

Today Iz is hard at work on an experiment involving the separation of element 94. He wants to verify the results of an investigation that he made in Berkeley the early part of last month on the possibility of

5/11/42

crystallizing out most of the uranium as nitrate from a mixture of uranium, fission products and 94. This is the kind of mixture that will be removed from the pile if a chain reaction proves feasible.

I wrote to Wahl in Berkeley and asked him to send me about half the fission product residue from the large neutron bombardment we made last summer, from which sample "F" was prepared (the 2-microgram 94^{239} sample that Emilio Segrè and I used to measure the fast neutron fission cross section of 94^{239}); the residue is for use by Coryell here and by Fajans at the University of Michigan. Half should be the rare earth fraction, and half should be the other fission products. I explained that Frank H. Spedding, Coordinator of Chemical Research at the Met Lab, is most eager that the study of fission products get started as soon as possible.

In the late afternoon I spoke again at the Chemistry Department seminar at the University of Chicago to complete my talk on artificial radioactivity and its applications in research. Because the Chemistry Department is not part of the Met Lab, I have to refrain here from mentioning the transuranium elements. In the preceding social session, Harkins talked further to me about his pioneer research in nuclear science, and I met additional members of the Department.

Tuesday, May 12, 1942

My group in the Met Lab Chemistry Division has been designated as Group I.

As Benedetti-Pichler promised, he sent lists of the equipment we will need for work on a gamma (microgram) scale. He advised us to get a Satorious microchemical balance so that when we construct our own ultra-microbalance, we will be able to calibrate it in terms of absolute mass. He also recommended a simple petrographic microscope and a binocular microscope of the Greenough type. In his letter he put in another good word for Cefola.

Much of today was set aside for correspondence. I wrote a letter

5/12/42

to Harrison Brown as a supplement to the telegram sent today by Stearns offering him a position starting June 1. I reminded him to send the diagrams of the fluorine generator so we can get the shops started on it as soon as possible. Another letter went to Donald E. Hull, who is on the Department of Chemistry faculty at the University of Minnesota (and was a roommate of mine in graduate school at Berkeley), asking about his interest in joining me if a position becomes available. I told him that probably he would have to take a leave of absence for a whole year as it is my guess that the project here will last the duration of the war. I added that the work here is extremely interesting and that I think it is the most interesting research work in which I have ever been engaged. Sometimes I feel a little apprehensive about inviting such people to give up their secure university positions and come to work at the Met Lab. They must gamble on the future of their careers, and how long they will be diverted from them no one knows. There is a statement of rather common currency around here and Berkeley that goes something like this: "No matter what you do with the rest of your life, nothing will be as important to the future of the World as your work on this Project right now."

Next I wrote separate letters to Stoughton, Gofman and Kennedy in Berkeley. I will quote at length from each of them, as this will summarize to some extent some of the matters I am concerned with at present.

To Ray Stoughton: "I hope that by now you have received the fifty pounds of material (thorium nitrate) which was ordered for your work. I presume that you are preparing this for the large neutron bombardment by removing the Pa²³¹ from it. I think that the 75 pounds of nitrate which we should have will be bombarded in this next long bombardment. It will not be possible to start the bombardment for several weeks yet because of the other large bombardment which is going on at the present time, but it will be well to prepare the containers for the material and make all the other necessary preparations for the bombardment. In the matter of preparing the containers you can probably get some ideas from looking at the arrangement that Kamen is using; in fact, probably you have already done this since I mentioned it to Gofman in a letter which I wrote

5/11/42

a week or so ago. I also suggested that this next bombardment be made with the solid thorium nitrate....

"Dr. Hamilton is returning to Berkeley in a few days with a zirconium residue which he obtained from the Port Hope plant. There is a strong possibility that this will contain a good deal of Pa²³¹. We would like to have you determine its Pa²³¹ content and then after that we can decide whether it might be worth while preparing another 5 or 10 micrograms of very pure, uranium- and thorium-free Pa²³¹. It appears likely that such a large amount of Pa²³¹ may be an essential item in our future program."

To Gofman: "I received your report on the fast neutron measurements yesterday. I think that it is a very fine piece of work; you and Friedlander are certainly to be congratulated for having done so well. I had already discussed with Professor Compton the general problem of U²³³ and it was agreed that this isotope is going to eventually play a very important role in the program....

"Dr. Hamilton has with some difficulty talked the New York representatives of the Port Hope people into letting us have another one-gram Ra-Be source, guaranteed leak-proof and contamination free. This is to be sent to Berkeley and the source which you now have is to be retained until this new source comes. It is my suggestion that you defer starting this new fast neutron program which I have been discussing above until the arrival of this new source. There are, of course, the number of things which I have mentioned that might be done in the meantime.

"I hope that you have been able to find a little time to work on the electrolysis of 94, but I can see that these fast neutron measurements must have taken a great deal of your time. I do think, however, that these electrolysis experiments are among the most important which are being done in the entire program of study of the chemical properties of element 94. It is the remote-control possibility that makes this type of procedure so important.

"I should like to hear from you your ideas concerning the continuance of the fast neutron measurements which I have outlined above.

5/12/42

I suppose also I will receive back the manuscript which I sent you last week with your and Stoughton's corrections on it.

"I want to emphasize very much the desirability of your being very careful in the handling of the secret letters which I have been writing to you. These should be locked up in your filing cabinet or, if you feel uncertain about this, you might ask Professor Latimer to lock them up for you in his safe. There is, as you will notice, quite a large part of the whole program of necessity discussed in these letters.

"By the way, do you have enough platinum sheet; if you do not, we can send you some since we now have a good stock."

To Joe Kennedy: "We are now moved into our domain on the fourth floor of Jones Laboratory and a large percentage of equipment is arriving. However, things are moving a little slower than I had hoped; and the problem of space is rapidly becoming as acute if not more so than it was in Berkeley. Still the only men here are English and Perlman, but I have located a number of others who will begin arriving from now on. Actually we did not have enough equipment on hand to begin to use more men until about now anyway. Covey, James and Knox are arriving from Berkeley next week—I think, I hope. Harrison Brown is coming up from Johns Hopkins at the end of the month and there are a few other men with whom the arrangements are still only in the tentative stage....

"I have seen quite a lot of Joe Hamilton during the last week or so. I run into him nearly every other day in Chicago or New York or some-place. He is in Chicago this morning and is leaving for Washington this afternoon; beyond that I don't know his official plans but I have a feeling that he will be moving around in the East indefinitely.

"Joe went down to St. Louis for me to arrange the details of the big neutron bombardment down there which Professor Compton is anxious to get under way. In this connection I have written to Prestwood asking him to ship directly and immediately to Alex Langsdorf 300 pounds of his ether-purified uranyl nitrate hexahydrate. We have on order a large amount of the nitrate and as soon as this comes we will ether-purify it here in Chicago and ship 300 pounds to Prestwood to replace that which we are stealing from him.

"You probably know about the fast neutron measurements that Gofman

5/12/42

has been making on U^{233} . It is fairly certain that U^{233} is going to play an important role in the general program in the future and Gofman has been doing a swell job so far. However, one of the chief sources of error is due to the small weight (1.3 micrograms) of the enriched U^{235} sample which you loaned to us. Do you have a sample containing some 5 or 10 micrograms of U^{235} , and only some four or five times as much U^{238} , which you could loan to Gofman for a few weeks?"

My day didn't end until midnight when I wrote Helen a shorter letter than usual.

Wednesday, May 13, 1942

I received a letter from Dan Koshland of the Shell Development Company inquiring about job possibilities. Koshland is the honors graduate of 1941 from the College of Chemistry whom Latimer recommends so highly. I responded, indicating that there is a good chance he will be invited to join our group.

The Washington cyclotron is presently operating only one shift per day. To get irradiations from there as fast as we can I got in touch with Langsdorf who will see if the staff can be increased to permit a 16-hour operation, and perhaps even a 24-hour operation. It is hoped that the irradiation of our big sample may be started this coming week.

I received three letters from Helen today, a result of pile-up in the mails, and wrote a contented reply to her several questions.

Thursday, May 14, 1942

Latimer wrote from Berkeley about my program there. He said that he has talked to Lawrence about it, and Lawrence is quite willing that the individual projects be set up as separate contracts through Compton. Latimer returned my program proposal with his endorsement, although he

5/14/42

thought it might be advisable to cut my budget of \$44,000 by ten percent. He mentioned also that Morris Perlman appears to want to work with Wahl and Lawrence and get out of this program. He hopes I will visit Berkeley soon.

After reading Latimer's letter I wrote to Perlman expressing my surprise and puzzlement over his desire to change positions. I suggested we discuss the whole matter when I come to Berkeley in about two weeks.

Friday, May 15, 1942

Most of my working day was spent at Northwestern University, where I had the opportunity of meeting and lunching with Professors Don Yost, Frank Gucker and Francis Blacet and also Dick Dodson. They have National Defense Research Committee contracts and thus we could speak freely about some of our common problems, one being recruitment. Don Yost and I talked about Theodore T. Magel, who received his Ph.D. in 1941 at Berkeley, where I knew him well. Magel is now in Urbana at the University of Illinois working on an NDRC project, although he is now on Northwestern's payroll. We agreed that Magel would be more useful to my group than to Yost's because of his Berkeley background and that I should make him an offer.

While I was gone, Spof English made sure that the University of Chicago cyclotron is not contributing to our Geiger counter background in 402 Jones, our counting room. His counter tube (ZC-1) is shielded with a 1-1/2 inch lead cylinder, and he got 50 counts/min background whether the cyclotron was operating or not. At the same time, Boyd got the same result in their counting room, 305 Kent Laboratory. Thank God for the granite walls in these buildings!

There was some mail piled up on my desk when I returned. One of the letters was from Brown. He said he has fluorinated Perlman's UF_4 mixture and sent the products and residue to me by express May 13. The

5/15/42

reaction went very nicely for Brown. After one hour of treatment with two fluorine generators, all the volatile material went over into the trap. He cautioned us not to open the trap under water because the hex gas will not react immediately with the water so that much will be lost in the bubbles. He suggested a procedure in which we first cool the trap in liquid air.

Iz has just about completed the crystallization experiment. He started the experiment Monday with 225 grams of uranyl nitrate hexahydrate (UNH) in water in a volume of 200 cc. To this he added as tracer some 50-year 94 that we brought from Berkeley. Ten percent of this solution was set aside to determine the amount of 94 alpha particle activity that was present. The remaining 180 cc of solution was slowly evaporated over steam and subjected to a two-stage crystallization procedure such that 90% of the uranium was removed. Element 94 was then isolated from this remaining mother liquor and from the original uranyl nitrate solution by the standard oxidizing and reducing procedure of precipitating the rare earth fluorides. By comparing alpha counts of the two 94 samples he shows that 62% of the 94 remains in the mother liquor, which now contains only 10% uranium. The result is identical to the one that Iz got the first time he ran the experiment in Berkeley last month. This six-fold concentration of 94 alpha activity promises a simple first step for the extraction of 94 from a mixture in which the major component is uranium.

A chemist, a former Berkeley colleague, wrote that he is interested in a position with me, but he made a number of impossible conditions about his working hours. I will have to write him that we have meetings two or three nights a week where attendance is mandatory for the successful prosecution of our work and that the group, working as a team on some experiments, may soon have to work Saturdays and Sundays, if not around the clock. I think he is lost to us. I also heard from Cefola and Saunders. Cefola will come, but he needs a letter from me to his Chemistry Department Chairman, W. C. MacTavish, in order to get a leave of absence; he may be able to join us the first or second week in June. Saunders has decided to stay at Caltech as he has been put in charge of

5/15/42

the chemical work on a new problem connected with the war effort; also he hopes to write up his thesis and get his degree by December.

Milton Burton arrived to start work late this afternoon and checked into the Mira-Mar Hotel where he will live until his wife Frances joins him. Spedding, English and I had dinner here in the hotel with him, which gave us an opportunity to acquaint him with his impending responsibilities. His laboratory space will be in Kent Chemical Laboratory.

Again my day went to midnight, when I wrote Helen and told her I will probably leave here on May 26 for my visit to Berkeley.

Saturday, May 16, 1942

At ten this morning I left what I was doing in Jones Laboratory and went over to Eckhart Hall to greet Elwin Covey, newly arrived from Berkeley, and get him off to a good start as a Laboratory Assistant. When he was finished with the usual security procedures—photographs, fingerprints, temporary badge and the signing of the Espionage Act—he came to my office; we strolled across campus to lunch at Hutchinson Commons, accompanied by Burton, English and Perlman.

Friedlander's security clearance has come up again. Compton and I had a long conference over it, and he told me that on his last visit to Washington he discussed the matter with Conant, but apparently no progress has been made. I was authorized to tell Friedlander—which I have just done in a letter—that he will be the Number One man if permission is granted for an alien to work for me, meaning that should only one alien be selected, that person will be Friedlander. Later I went to see Stearns in his office and I urged him to hire Magel; Stearns said he would make the offer today. I followed up this conversation with a letter of my own to Magel, informing him of my conversation with Yost at Northwestern yesterday, and alerting him to the impending formal offer from Stearns.

5/16/42

I replied to Cefola's letter, saying that Stearns was writing to MacTavish today regarding his leave of absence from New York University. I agreed to his time of arrival on the job the first or second week of June but asked if he would come to Chicago next week for a day or two at our expense. There is now a considerable delay in procuring material of all sorts, and so it would be expeditious if he comes here now to help us order all the apparatus and ancillary equipment that he will need for his ultramicrochemistry work.

Wahl wrote about the fission product residue he is sending from Berkeley at my request. In the wax bottle I will find a little more than half of the aqueous extract (containing all the fission products except the rare earths) from the 14,000 microampere-hour neutron bombardment of 1900 grams of UNH that yielded 94^{239} sample "F"; this extract has the rare earth fluorides removed by centrifugation. Also there will be a lusteroid tube, and I will find in it about one-third of the rare earth (Ce and La) fluorides from the bombardments that yielded 94^{239} samples "F" and "L". The rare earth fluorides were combined by Gofman in Berkeley in March during a procedure wherein he further reduced their 94^{239} content. He reminded me that the bombardment that yielded "F" took place during June of last year, and the bombardment that yielded "L" (15,000 microampere-hour neutron bombardment of 1200 grams of UNH) took place during March of last year.

Leo Levanas, a UCLA chemistry classmate of mine, wrote a cordial and humorous letter suggesting that we get together for dinner whenever I visit Los Angeles. Winstein, acting on my letter of April 27, had informed Leo of my need for a good chemist. His interest is piqued as he has only the vaguest notion of what we are up to here. He presented, however, a number of valid reasons for retaining his present job.

I have been hunting for an apartment for Helen and me and today found an available one on Woodlawn Avenue, on my regular route to Jones Laboratory. This is in "Oxford Apartments" at 6128 Woodlawn Avenue, about a block north of the Mira-Mar Hotel. I rented it immediately for occupancy by June 1. It is furnished and the rent of \$62.50 per month

5/16/42

includes maid service. It is small but will suffice until we can find something better.

Burton and I had dinner together at the White House restaurant on 63rd Street, and Covey went with us. Afterwards I wrote a note to Helen and told her about some of my recent activities, including my locating and renting an apartment for us.

Sunday, May 17, 1942

After spending the morning writing reports, I had lunch with English and Covey shortly after one o'clock, and then English and I walked over to our lab. The day was beautiful and clear. I continued writing during the afternoon. I wrote to Helen in the evening.

Samuel K. Allison has issued his weekly report, "Status of Research Problems in Experimental Physics." Experiments on the intermediate piles, Nos. 4 and 5, have been completed and two more will soon be constructed. Three carloads of material and equipment were received from Columbia University in connection with the transfer of their S-1 activities. The crates and cartons were hauled from the freight train to the West Stands Laboratory by truck and most of them have now been opened. There were some 1200 cartons, a large number of which contained graphite bricks and uranium oxide cylinders. Most of the cylinders and bricks were placed directly on pile No. 5 as they were unpacked. The whole structure is geometrically identical to the last Columbia University pile. It consists of the uranium oxide in 3-inch cylindrical holes the units being in a simple cubic lattice with 8-inch sides. The value of k is close to 0.99.

Monday, May 18, 1942

Ralph James, who received his B.S. degree in chemistry at Berkeley early this month, arrived from Berkeley to join my group as a Research

5/18/42

Assistant. His salary was set at \$150 per month. He will work in Room 404 of Jones Laboratory. We put him to work immediately to help English at laboratory bench no. 1. They are starting today to process our first bombardment in the Washington University (St. Louis) 45-inch cyclotron-- the 500 microampere-hour deuteron bombardment of uranium metal performed on May 5 and 6. They dissolved about half of the deuteron-bombarded uranium from which they plan to separate the 50-year 94, using our standard oxidation-reduction cycles with rare earth (La-Ce) carrier, in order to determine its yield. A knowledge of the yield from 12-Mev deuterons, to compare with the yield from 14-Mev deuterons in the Berkeley 60-inch cyclotron, might enable us to make an isotopic assignment of the 50-year 94, to mass number 238 or 235. They set aside the other 50% of the deuteron-irradiated uranium with the aim of later performing volatility experiments on its contained 94.

Brown sent a letter saying that he will report for work two weeks from now and will soon forward the drawings and specifications for the fluorine generator. His package arrived also, containing the fluorination products of Perlman's UF_4 mixture. When we opened it, we found a copper boat to which was stuck a white powder residue, and a brass trap containing the UF_6 distillate. Perlman spent the rest of the day finishing his crystallization work, but tomorrow he will take the UF_4 products and start the alpha particle measurements to locate the disposition of 94 in this fluoride volatility experiment. He hopes to have some results by the end of the week.

The mail brought a May 15 letter from Dan Koshland, indicating extreme interest in joining my group and asking what procedures to follow in notifying his local draft board. I asked Stearns to send Koshland a formal offer and to handle the draft board matter.

In the many personal letters that Helen and I have exchanged since my moving to Chicago, we have often discussed our impending marriage; finally we decided that the most propitious time for the ceremony will be the first week in June. Helen has already resigned from the University of California Radiation Laboratory, effective May 30. I

5/18/42

expect by then everything will be running smoothly in the lab here under Perlman's direction. While in California I hope to do some recruiting as well as spending time with Latimer and my colleagues on the Berkeley project.

I wrote letters to both my friends, Saul Winstein and Leo Levanas, suggesting that they come to see me at my parents' home in South Gate, California (9237 San Antonio Avenue) on Friday, June 5. Perhaps I can persuade at least one of them to sign on with me here. They are both outstanding chemists and would be extremely helpful to the Project.

The U^{233} report went back to Gofman with the corrections and additions he has suggested so he could mark any final changes in the manuscript.

Breit resigned today and will be leaving the Met Lab. He and Compton disagree over security practices. He feels these should be more strict and an alien like Enrico Fermi shouldn't be allowed so much freedom of action. Breit is a theoretical physicist, and in addition to his duties here he has coordinated the fast-neutron experiments being conducted around the country. He is disillusioned because he is not getting the Government support he thinks these activities require. I don't know about his future plans.

I again wrote Helen as my last act late tonight, having received two letters from her today, one at the Met Lab and one at the hotel.

Tuesday, May 19, 1942

All the group leaders are now expected to submit weekly reports which are due at noon on Tuesdays. My first report today is entitled, "Report of Week Ending May 16, 1942. Group I: Chemistry of 94," and describes Perlman's experiments on the crystallization procedure for concentrating 94 from a UNH solution. This is Report No. CC-79, the CC standing for "Chicago Chemistry."

5/19/42

I had lunch at the Quadrangle Club, where I have been elected to membership. The Club was formed in 1895 for members of the University who are interested in literature, science or art, and is for the purpose of mutual improvement and social recreation. Ernest Lawrence came by my table and shook hands with me—Helen told him last Saturday of our coming marriage and suggested she terminate her position as his secretary at the end of the month. The cat was out of the bag, so to speak; so I told Compton and Burton of my plans, who had overheard Lawrence congratulating me. At last my secret is out, which I have guarded as closely as anything pertaining to the War Effort.

Lawrence was particularly friendly, and it is the first time he has visited the Met Lab since I came here. I showed him around our Jones Laboratory area and then went with him by taxi to the railroad station, meanwhile discussing business such as the progress of our work on 94 extraction and the Latimer Berkeley contract. I could tell he was privately assessing our progress in producing and isolating 94 against his own isolation of U^{235} , and I must confess I was doing the same. Already the mass spectrograph using the old 37-inch cyclotron at Berkeley, which he calls the "calutron," is spawning micrograms of uranium enriched in U^{235} . As for element 94, the total world production is only a few micrograms, and so far none has been isolated in pure form. Lawrence is excited about stepping up his program next month, because then he expects to start operation of a new calutron using the brand new 184-inch cyclotron magnet, which reposes on the hill in back of the campus.

Today marks the first day of the second month I have been here. Lately I have been worried about Frank Spedding, the Director of Chemical Research here at the Met Lab, spending so much time at Iowa State University, Ames, Iowa, where he is in charge of a fast-growing associated project; he is trying to run the Chemistry Division's program here—the work of the groups under Coryell, Burton, Boyd and me—in absentia. The pace of the work is much too fast to make this feasible. Burton and Coryell feel the same way. They elected me a committee-of-one to speak to Compton; so I made an appointment for tomorrow morning with Compton.

5/19/42

I am now giving a course in nuclear chemistry for Met Lab members, so many of whom have had no previous experience in nuclear research. My lectures are scheduled for 8:30 p.m. in Room 316, Eckhart Hall. My first lecture tonight was on the fundamental properties of nuclei. It was satisfying to see such a good turnout.

When I wrote to Helen tonight I described my meeting with Lawrence and why the subject of our wedding is now "declassified." Earlier today I dashed off a short letter to her suggesting that she arrange to hire as a secretary for the Berkeley chemistry group her friend Lois Moquin, whom she recommended in response to my request that she try to find a suitable candidate for that position.

Wednesday, May 20, 1942

I went to Compton's office in Eckhart Hall today, and we discussed a number of items. He opened our conference by saying he has discussed the Berkeley Chemistry Department Contract with Lawrence, who agrees with this method of operation. The contract will be with the Metallurgical Project and the amount will be \$44,000, as I recommended. I asked whether a project for Professor W. F. Giaucque of the Berkeley Chemistry Department will be approved, and he said it will not. (This means C. S. Garner, originally scheduled to go with Giaucque if such a project materialized, will continue on Metallurgical Project work either with the Berkeley group or with my group here.)

I then brought up the administrative problems of the Chemistry Division. I asked about the future roles of Coryell, Burton and me in the direction of the chemical program.

Then Compton turned to another question. In about six months a mature chemist of national reputation will be needed to take charge of the whole chemical program in Tennessee; the level of responsibility would be about equal to Compton's present position. I suggested Latimer. (I believe that he will make this recommendation to Conant.) I also suggested that he try to bring Gilbert N. Lewis, the long-time Dean of

5/20/42

Chemistry at Berkeley, to the Metallurgical Laboratory as a consultant this summer--he said he will try to arrange this.

My conference with Compton lasted about an hour and a quarter, and I believe it was very productive. After the meeting I dictated a letter to Latimer, summarizing the discussion about the contract and informing him that Compton has a proposal in mind about him and that I would reveal it to him on May 29, the day I arrive in Berkeley.

My other correspondence was mostly about employment. Magel, I am happy to note, accepted a position with us and will join my group June 1. He would like to come here and meet with me this week. I wrote to E. F. Orlemann, an instructor at the University of California in Berkeley and a former colleague, concerning my forthcoming visit to Berkeley and suggested that we talk about his joining my group here; I discussed this with him last month before I left Berkeley. I sent letters to C. S. Garner and Morris Perlman, who are in the Berkeley group, saying that I wish to see them during my forthcoming visit. To Garner I gave a standing invitation to become a member of my group here any time he wishes.

In the late afternoon I went to the Met Lab picnic in Ida Noyes gymnasium. Once inside we forgot the cold and rain, so many activities were going on--ball, ping pong and bowling, for instance. There were many young people about, all having a lively time. We had a box supper and then sang songs. A highlight of the evening was the rather sedate Compton himself playing "Don't Sit Under the Apple Tree" on his banjo. I missed Helen and so wrote her a letter as soon as I got home, telling her about my interesting meeting with Compton, the Met Lab picnic, etc.

Thursday, May 21, 1942

Kennedy wrote in response to my letter of May 12. He said he will give Gofman the enriched U^{235} as I requested. Spedding wants him to spend a month or two at his laboratory in Ames, helping them start a 94 tracer program. In my reply I discouraged him from considering the move, pointing out that Compton has not approved the program and that to

5/21/42

staff another such program adequately, such as here and at Berkeley, is not feasible. He said that Hamilton returned to Berkeley and that the St. Louis bombardment will be off to a fast start. He was somewhat upset by Berkeley's pace—he indicated, sarcastically, that it might take up to a year to get the microampere-hours of bombardment that he wants. He terminated his letter with the remark, "Rumor has it spread around rather definitely (though not at all widely) that your trip back here this month will not be for business alone." So I asked him not to increase the "width" but leave that to the discretion of the other party concerned.

The 300 pounds of UNH was shipped from Berkeley today to go to St. Louis for our neutron bombardment.

I have learned that Halban would like to bring his University of Cambridge heavy-water research team here, but this seems unlikely for security reasons. Also, because of the political rivalry between the U.S. and Britain, he may end up in Canada. Both Urey and Halban are pushing to use heavy water instead of graphite (Fermi's idea) as the moderator for a pile.

I wrote my usual late evening letter to Helen.

Friday, May 22, 1942

Cefola was in town today at my request. He came here thinking he would be analyzing materials for impurities at the micro or ultramicro level. I told him, unofficially and confidentially, about element 94 and how he will have to deal with it after isolating only a few micrograms. We looked for a good spot that would be vibration-free for the microbalances and settled on Room 405 (a former darkroom) in Jones Laboratory which has a concrete bench. We discussed ordering micro-manipulators and microscopes and how to procure German-made Zeiss equipment. He said he will report to work here in about three weeks. Magel showed up, too, to go through some of the equipment preliminaries;

5/22/42

he will start June 1. The drawings and specifications for the fluorine generator arrived from Brown as he promised. We ordered the items on his list and placed a shop order for the things that Brown wants to have built.

I had dinner with the Perlman's at their apartment on Drexel Boulevard, the best dinner since my arrival in Chicago. After my return home I wrote to Helen. Three letters from her arrived today, a pleasant concentration of news due to pile-up in the postal service.

Saturday, May 23, 1942

William J. Knox, who received his B.S. degree in chemistry from Berkeley early this month, arrived today to join my group as a Research Assistant. He will work in Room 404, Jones Laboratory, and will receive the standard \$150 per month. I have asked him to work with Perlman in order to give him some tutoring and guidance. Now Perlman has Knox as a helper working with him at laboratory bench no. 2. Perlman has set up his desk against the wall at the south end of the area between laboratory benches 1 and 2. The large fume hoods are opposite laboratory benches 1 and 2 in a convenient location for English's and Perlman's work.

Iz has now completed his assay of the white powder residue from the fluorination of the UF_4 to which 50-year 94 tracer was added. Starting last Tuesday, he carefully brushed the residual powder away from the copper boat. Of the 3.6 grams of UF_4 that Brown had fluorinated, about 0.5 gram (probably a mixture of CuF_2 and ZnF_2) remained in this residue. He dissolved the residue in HNO_3 and washed the boat with additional nitric acid. The 94 was isolated from the combined solutions by the standard rare-earth fluoride oxidizing and reducing procedure. The alpha count was 4,950 counts per minute. Next he took a gram of UF_4 containing the 94 tracer (from the same batch as that used in the fluorine treatment) and went through the same procedure. This assay shows that the amount of 94 alpha activity in the other 3.6 grams is roughly

5/23/42

equal to that in the dissolved residue, showing that hardly any of the 94 went over into the distillate. Iz will check the activity in the distillate on Monday.

While I was writing to Helen this evening, Knox came by to see me in my hotel room. We had an hour's chat which helped us get acquainted. He has a girl friend in Berkeley and is worried about the separation. I am well impressed with him. I feel very fortunate to have found people like Knox, James and Covey to join my group. The three of them have taken up temporary living quarters in the Mira-Mar Hotel.

Sunday, May 24, 1942

I took a walk to nearby Jackson Park with Burton, did some writing and ended the day with a letter to Helen.

Monday, May 25, 1942

Today Iz set about isolating the 94 from the distillate in the copper trap by the standard method. He found only 20 counts/minute in the entire fraction! Compared with the 4,950 counts/minute in the residue, this certainly confirms the non-volatility (or slow rate of formation) of plutonium fluoride in its higher oxidation state(s). Unless there are unforeseen factors, we think the possibility of a large-scale operation should be considered.

John Willard came down from the University of Wisconsin today at Spedding's invitation. Spedding, Burton and I had lunch with him at the Quadrangle Club. Spedding offered him a position at Ames and I offered him a position with my group at the Met Lab. He prefers to come to the Met Lab and has written to Stearns asking if he can come for the summer.

Tuesday, May 26, 1942

I prepared the second weekly report (No. CC-94) entitled, "Report of Week Ending May 23, 1942, Group I: Chemistry of 94," discussing Perlman's and Brown's work on the fluorination experiment, and offering the conclusion that the non-volatility of the fluoride in the higher oxidation state (or states) of 94 might offer the basis for a method of removing the bulk of uranium when it is mixed with element 94 and fission products.

We find the use of "copper" as a code word for 94 too awkward. So in my report I state: "For convenience, whenever a formula of a compound of 94 is written we will use the chemical symbol 'Pu' for 94 (corresponding to the name plutonium) and we will assume an oxidation number of +4 for its lower (fluoride insoluble) oxidation state."

Professor Merle Randall of the Berkeley Chemistry Department is in Chicago today and spent some time with us. I discussed with him his program for enriching deuterium and oxygen isotopes by the distillation of water.

I telephoned John Willard at the University of Wisconsin Chemistry Department in Madison to explore further the possibility of his joining my group. He is carrying on research with "hot atoms" produced in nuclear reactions and thus is one of the few people with a background of experience that is relevant to our research program. I have followed his research program and have served as a referee on one of his papers. He is interested but would prefer to accept only a summer appointment until he has a chance to judge the relative importance of the work here and in Madison. I suggested that he write to Stearns about this and indicated that I will call him again upon my return from California.

Tonight at seven o'clock I gave the second lecture of my evening course on nuclear chemistry. The time was earlier than the regularly scheduled 8:30 p.m. in order that I might catch my train. My topic was on the nature of nuclear reactions. Compton was in the audience and he

5/26/42

saw me alone in his office afterwards. We talked about the reorganization of the Laboratory and my status as group leader, a continuation of a talk we had earlier in the day. He said he has decided to have me and my group work independently, but he is not sure about the details of the arrangement—he will work this out soon. We finished the conversation at 8:30, and Iz drove me at a hectic pace to the Chicago and Northwestern Railroad Station. We arrived with only thirty seconds to spare before the San Francisco Overland departed at 9:00 p.m. for Berkeley. While I am gone, Iz will oversee the affairs of my group. He plans to experiment on whether or not plutonium in tracer amounts co-precipitates with uranium in uranium peroxide.

Wednesday, May 27, 1942, and Thursday, May 28, 1942

I worked on writing reports and reading Project material during most of the day and evening while enroute to Berkeley on the Overland.

Friday, May 29, 1942

The train arrived in Berkeley at 7:15 a.m. and Helen was at the station to greet me. Melvin Calvin, good friend that he is, got up early to be there also. He told us of his girl friend, Genevieve Jemtegaard, and we are anxious to meet her. We had what might be termed a "jolly" breakfast and then drove to the campus. While Helen and I were walking near Gilman Hall, we ran into Professor G. E. Gibson, under whom I took my Ph.D. in Berkeley. In his absent-minded way he said, "Say Glenn, when will you be going to Chicago?" The War will be over before he realizes how much the University is involved.

Later this morning Latimer and I sat down in his office to talk about the Berkeley program. It was then that I told Latimer that Compton is thinking of having him take charge of the whole chemical program in Tennessee. Latimer was pleased and said he would help all he could. I also conveyed the message that Compton will support Latimer's application

5/29/42

for a chemistry program to be carried out in Berkeley, its chief objective being the study of the chemistry of plutonium.

After lunch at the Faculty Club I visited Gofman and Friedlander, in Room 307, Gilman Hall. We discussed their role in doing further experiments for the Berkeley program. They will measure fast-neutron fission cross sections of 94^{239} , U^{233} , U^{235} , U^{238} and Pa^{231} , using a one-gram Ra-Be source of neutrons; we are acquiring another one-gram Ra-Be source from the Canadian Radium and Uranium Company in New York, to replace the one we purchased from them because this is leaking radon which contaminates our counting instruments. I also discussed with Gofman his work on the chemistry of 94 to which he is devoting an increasing amount of his time; we at the Met Lab are especially interested in his electrolysis experiments which seem to show that 94 in an acetate buffer solution is deposited on the cathode (presumably as an oxide) at a higher rate when it is present in the oxidized state than when it is present in the reduced state. I also discussed with him the final touches on our joint report (with Stoughton) on the properties of U^{233} , which will be issued as a Met Lab "CC" report. I also tried to encourage Friedlander to be patient regarding my attempts to obtain security clearance for him so he can join me at the Met Lab.

I had a talk with Joe Kennedy about the status of his work on the isolation of enriched U^{235} and the large neutron bombardment at the 60-inch cyclotron to produce 94^{239} . I then saw Hamilton and reviewed his work at St. Louis helping to set up our cyclotron bombardments and investigating the possibility of recovering Th^{234} (UX_1) as an additional source of U^{234} for our Berkeley program; we also discussed the arrangements for the Metallurgical Project's continuing use of the Berkeley 60-inch cyclotron.

Tonight Helen and I had dinner with her mother at her apartment (on Ashby Avenue near Telegraph). I spent the night at the Faculty Club, which will be my residence until I leave for Los Angeles, with Helen, next Thursday night.

Saturday, May 30, 1942

Today is Memorial Day.

The papers are filled with hate. Today's headlines say, "Czech Slaughter Begun by Nazis," and the San Francisco Chronicle urges that we "bomb Tokyo some more," saying that we will surely be bombed in retaliation for our Tokyo air raid--and if we are, well, we can take it. The Japanese Minister of Justice admits that our American raid over Tokyo last month terrorized the Japanese people and their officials fear further lowering of public morale. Authorities in the United States are also acting out of fear. Already 100,000 Japanese-Americans have been cleared from their homes and farms along the Pacific Coast, or are under orders to move.

I spent much of the day visiting the fellows in the group whose research on heavy isotopes I directed before I left Berkeley to go to Chicago in April. They are all still working on the third floor of Gilman Hall (except Wahl who is working in Room 120, Gilman Hall). Gofman and Friedlander are working part of the time in Room 234, Old Chemistry Building, where they are measuring the fast neutron fission cross sections of heavy isotopes using our one-gram Ra-Be neutron source. The chemical identification of element 94, corresponding to its discovery, took place in February of last year in Room 307 (Figure 6). The measurement of the radioactive properties of the 50-year 94 and 94^{239} early last year, and of U^{233} early this year, took place in Room 303, which houses our counting equipment and served as my office before I left Berkeley. These isotopes were produced by use of the 60-inch cyclotron in Crocker Laboratory. The slow neutron fissionability of U^{233} was first demonstrated using a Ra-Be source of neutrons.

This was Helen's last working day at the University of California Radiation Laboratory. We spent the afternoon and evening with Melvin and his new friend Genevieve.

5/30/42

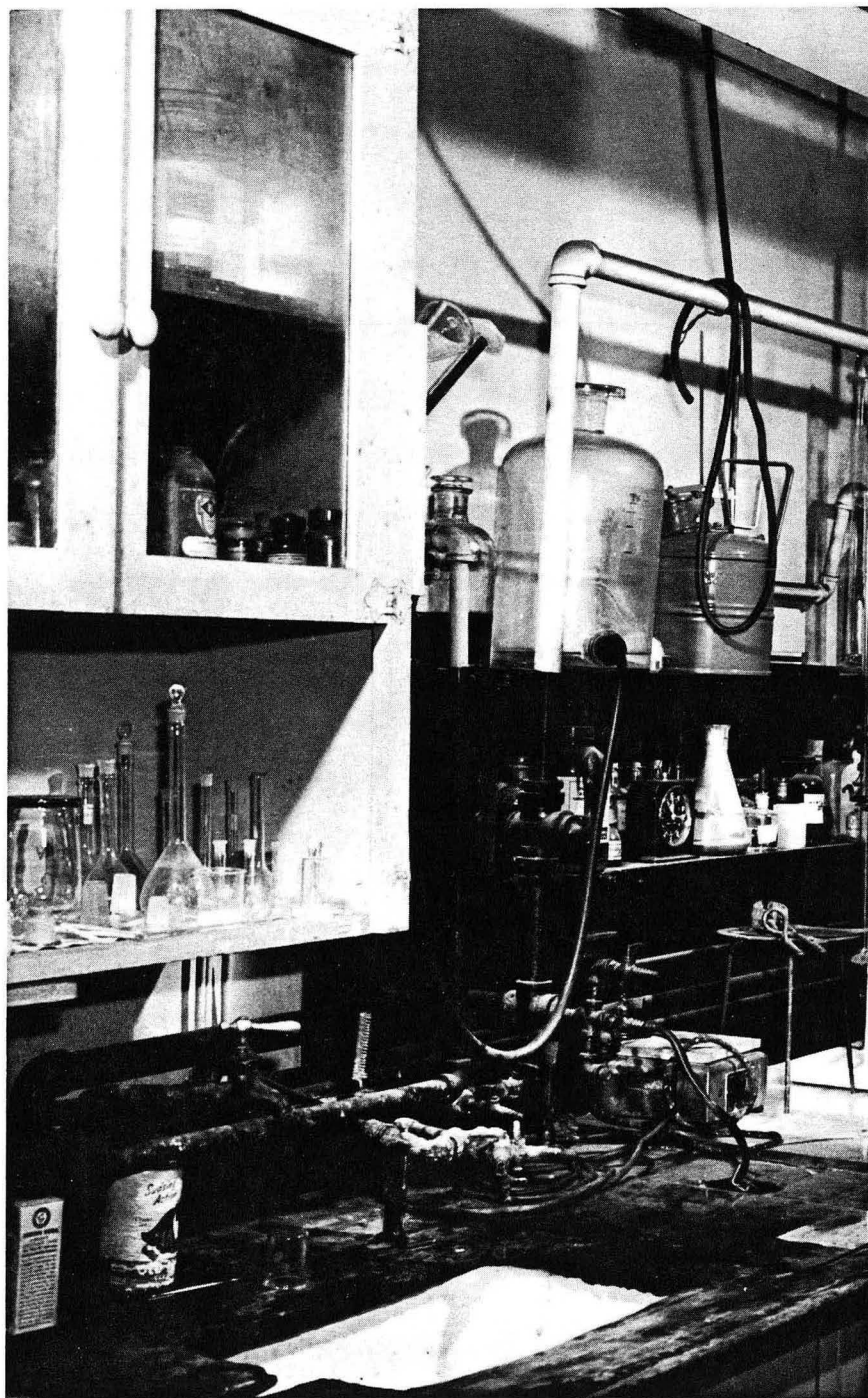

Fig. 6
Room 307,
Gilman Hall,
UC Berkeley
campus. (Photo-
graph taken
February 21,
1966, when the
room was still
much the same
as it was at the
time of the
first chemical
identification
of plutonium.)
Morgue 1962-38

Sunday, May 31, 1942

This afternoon Helen and I attended a cocktail party in our honor given by the Latimers at their home at 810 Euclid Avenue. This is in recognition of our marriage next week and many members of the Chemistry Department faculty, and their wives, were there including the Gibsons, Lewises, Rollefsons, Eastmans, Porters, Stewarts, Olsons, Pitzers and Joe Kennedy.

JUNE 1942

Monday, June 1, 1942

There are huge headlines in today's San Francisco Chronicle: GREATEST RAID IN HISTORY. 1000 Bombers Raze Cologne. British Drop Six Million Pounds of TNT in 90 Minutes; Nazi Industrial Heart Left in Flames.

This morning I went to the Department of Biochemistry in Life Sciences Building where I talked with Paul Kirk with whom I exchanged letters a month ago. He introduced me to Burris B. Cunningham, his recent Ph.D. student, an expert ultramicrochemist, and the one that he recommended so highly in his letter. Because Cunningham is the type of man that my group needs, I offered him a job on the spot, and he accepted. He will be able to report to work July 1. I am still pursuing my rather far-out idea that it will be possible to produce enough 94 through the bombardment of uranium with cyclotron neutrons so that we can isolate it and study it in pure form by ultramicro techniques. Of course I could say nothing of this to Kirk and Cunningham.

I also spent much of the day with the members of my old group on the third floor of Gilman Hall. I spoke with Wahl about his progress in studying the chemical properties of element 94 and with Clifford Garner, who has joined the group since my departure last April and who is carrying on, along with Norman Bonner, my program to search for 94^{239} in uranium ores. Garner, from the University of Texas, is an old friend whom I have known since his graduate student days at Caltech, and for whom I arranged a position with the Berkeley group. Bonner, who participated in our discussions, just finished his undergraduate work in chemistry and worked with me before my departure on the isolation of U^{234} , via the 24-day Th^{234} (UX_1) intermediate, from large amounts of UNH. I also talked with Morris Perlman, who worked with me on the isolation of small quantities of 94^{239} from pitchblende ore and who explained why he has decided to shift to Joe

6/1/42

Kennedy's program where he is urgently needed to help on the chemical programs associated with the separation of U^{235} by the electromagnetic method (Lawrence's program).

Tuesday, June 2, 1942

Ray Stoughton, who is working in Room 311, and I went over the work that he has been doing on the Berkeley project. We also had a chance to talk about our joint paper, co-authored by Gofman, on the properties of U^{233} . We expect its publication as a Laboratory Report in a week or so. It will be rather long; it sums up all our investigations on U^{233} , including the various experiments performed to measure the radioactive and fission properties of U^{233} and the chemical procedures followed.

We also discussed future experiments on the separation of thorium-232, protactinium-233 and uranium-233 by the fluorination method. I proposed that he prepare some thorium fluoride incorporating 7-day U^{237} tracer and then send it to us at Chicago for fluorination. We will then return it so that he can identify the U^{237} to see whether it will be found in the volatile uranium hexafluoride fraction as expected. In addition, we discussed the optimum ratio of hydrogen to thorium for his forthcoming large bombardment of thorium with neutrons at the 60-inch cyclotron to produce more U^{233} , and parent Pa^{233} , for experimentation purposes. Ray is a good Ph.D. chemist and enthusiastic about his participation in the program.

Helen and I were invited to the Kenneth Pitzers' for dinner at 12 Eagle Hill. Many of our Berkeley friends were there, but I regret that we will not be able to see all of our friends before we depart on Thursday.

Wednesday, June 3, 1942

I spent the day talking with the fellows on the third floor of Gilman Hall. I discussed with Beppino J. Fontana, whom I hired as a member of my Berkeley group early this year, his progress on the isolation of U^{234} ,

6/3/42

via 24-day Th^{234} (UX_1), from large amounts of UNH. Gofman will use the U^{234} to measure its fission properties. I also talked with René Prestwood, who just finished his undergraduate work in chemistry at Berkeley and who worked with me as a research student on the problem of isolation of U^{234} . He is engaged in the purification of large batches of UNH by the ether extraction method and furnished us with 300 pounds of purified UNH for our neutron bombardment at the St. Louis cyclotron. This work on ether purification of UNH and the extraction of UX_1 , with which Isadore Perlman was associated before he left Berkeley, is taking place in Room 301.

In addition, I talked with John Hamaker about his plans to commence an ultramicrochemical program of investigation of the chemical properties of 94 and with Glenn Sheline, who will also be engaged in this program. Hamaker has been doing his graduate work under my direction, and Sheline is an outstanding recent Berkeley Ph.D. in physiology whom I hired for the Berkeley chemistry group just a few weeks before I left. They are working, along with Robert Duffield, in Room 305.

This evening Ernest and Molly Lawrence took Helen and me, along with Don Cooksey and Milicent Sperry, dinner-dancing at the Mark Hopkins in San Francisco. We enjoyed the music of Henry King and his orchestra, who are appearing in the Peacock Court. Night life in San Francisco is now somewhat abbreviated, because starting last Saturday there is a curfew between midnight and 9:00 a.m. in taverns and all other places where liquor is served. Milicent and Don seemed unusually excited and exuberant; we suspect that they, too, will get married soon. Milicent works for the Physics Department as a secretary, and Don is Assistant Director of the Radiation Laboratory.

Thursday, June 4, 1942

I had further discussions with the fellows on the third floor of Gilman Hall. In the afternoon I had another session with Joe Hamilton, this time to discuss the matter of charges for the cyclotron time used in Stoughton's bombardment of thorium with neutrons. I pointed out that my

6/4/42

O.S.R.D. contract no. OEMsr-206 has a provision for 600 hours of bombardment time in it and that the government has so far been billed for only 150 hours. Since this contract was for the purpose of covering my U²³³ work and since it expires on August 1, 1942, I suggested that he check with Professor Lawrence to be sure the government is billed for the remaining 450 hours.

This evening Helen and I boarded the "Lark" at the Oakland Southern Pacific Depot. Melvin Calvin saw us off on this, our first leg on our way to Caliente, Nevada, where we will be married. Helen has booked for us separate roomettes from Oakland to Los Angeles and from Los Angeles to Caliente, and a bedroom from Caliente to Chicago.

Friday, June 5, 1942

When we arrived in Los Angeles this morning, my sister Jeanette was waiting to greet us. We spent an enjoyable day with my parents at their South Gate home and with relatives and friends, and we had dinner at Jeanette's and Harold's (her husband) house. Helen met my parents, sister, other relatives and friends for the first time (Figure 7). Saul Winstein and Leo Levanas dropped by to discuss my invitations to them to join me at the Met Lab. My former high school friends, Rita and Clayton Sheldon with their son Ronnie, came to see us at my parents' home. Later my sixteen-year-old cousin, Lloyd Johnson, came to Jeanette's house to see us. My parents, Jeanette, Helen's mother and relatives saw us off in the evening at the Los Angeles Union Station.

Saturday, June 6, 1942

Helen and I arrived at the railroad station (Figure 7a) in Caliente, Nevada, at about 10 a.m. We stored our bags with the station master, who was also the telegraph operator, and went in search of the city hall or office where we might obtain a marriage license. We learned, to our vexation, that there is no place to get a license in Caliente and that we would have to go to the Lincoln County Court House in a town called Pioche, some 25 miles to the north.

6/6/42

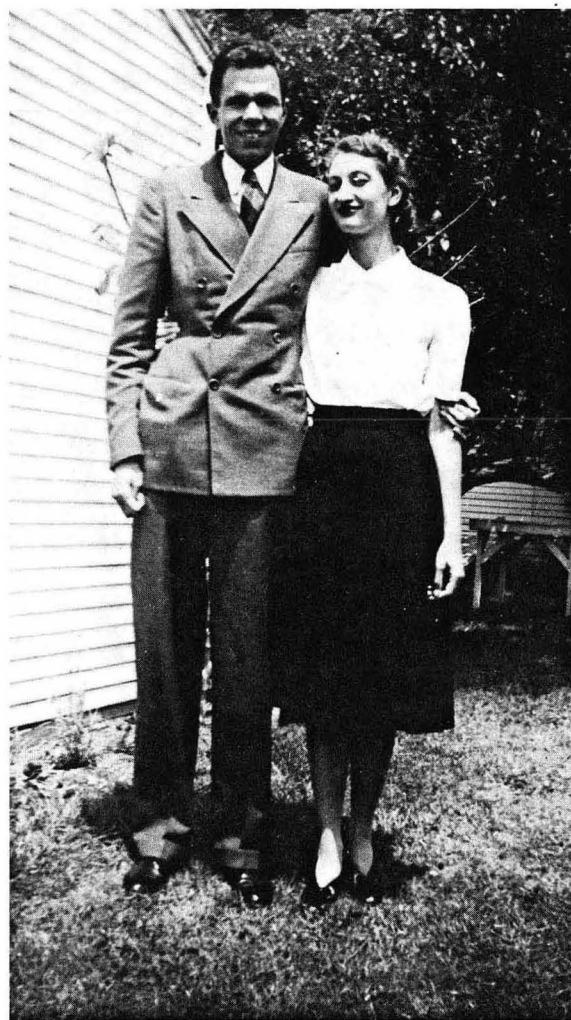

*Fig. 7 Helen and Glenn at South Gate,
California, June 5, 1942.
(XBB 768-7452)*

6/6/42

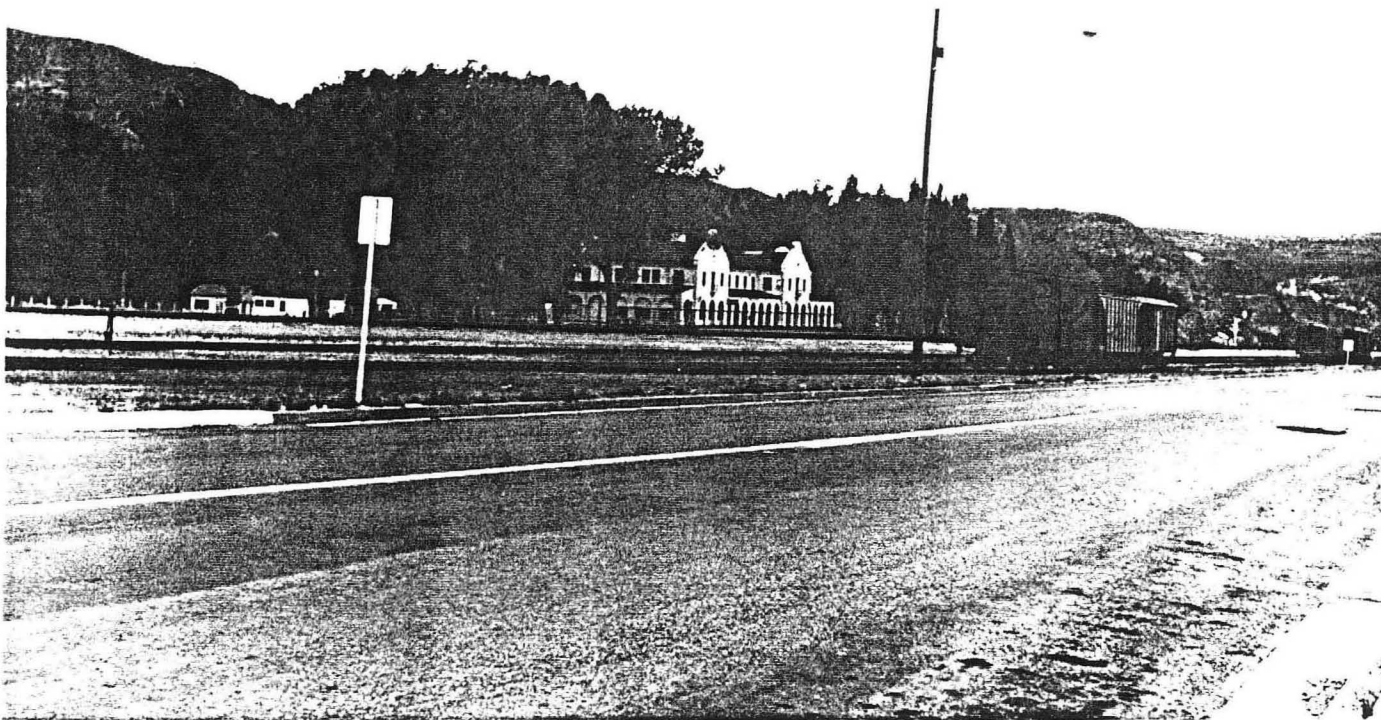

Fig. 7a Railroad station at Caliente, Nevada, approx. 1942

6/6/42

Seemingly aware that as strangers in town, we were faced with a problem, a young man serving as a deputy sheriff approached us. His name was Frank Anders (Figure 7b), and he was the son of the station agent, Howard Anders (Figure 7c). Frank recognized me--he had just graduated from the Chemistry Department at Berkeley and was working during the summer here in his home town of Caliente. Frank was most helpful; he not only helped us call Pioche to make sure that someone would be on hand at the courthouse which usually closed at noon on Saturday, but he also arranged for a ride to Pioche for us in the mail truck--there was no public transportation.

Helen and I rode to Pioche, travelling along a road that went through the town of Panaca; the driver delivered the mail all along the way. We arrived at the Court House (Figure 7d) in Pioche at about 12:40 p.m. and found the assistant county clerk waiting for us, thanks to the phone call. She made out our license, and it was obvious that she was more nervous than we were. She then kindly offered to go in search of the minister, the only one in town, but he was nowhere to be found. However, she guided us to a restaurant on Main St. and, while we were eating lunch, she rounded up the Justice of the Peace, Edgar L. Nores (Figure 7e). Nores came into the restaurant and said that he and the assistant county clerk were across the street waiting for us. As soon as I finished my apple pie, we found them and went back to the Court House where Judge Nores performed the wedding ceremony in his office. Our witnesses were Johnson W. Lloyd and Lilith Smith. After the ceremony Judge Nores handed the marriage certificate to Helen with the statement that I should keep my hands off it.

Helen and I spent some time exploring Pioche until about 4:30 p.m. when the mail truck returned to Caliente. There we checked into the hotel, whose lobby was on the first floor of the railroad station with rooms on the second floor. Also, on the first floor were offices, the waiting room, a restaurant called the "Beanery," and the registration desk. After dinner Helen and I went to a movie in the Rex Theater (Figure 7f) before spending the night in our hotel room.



*Fig. 7b Frank White Anders
1942*



Fig. 7c Howard Clay Anders

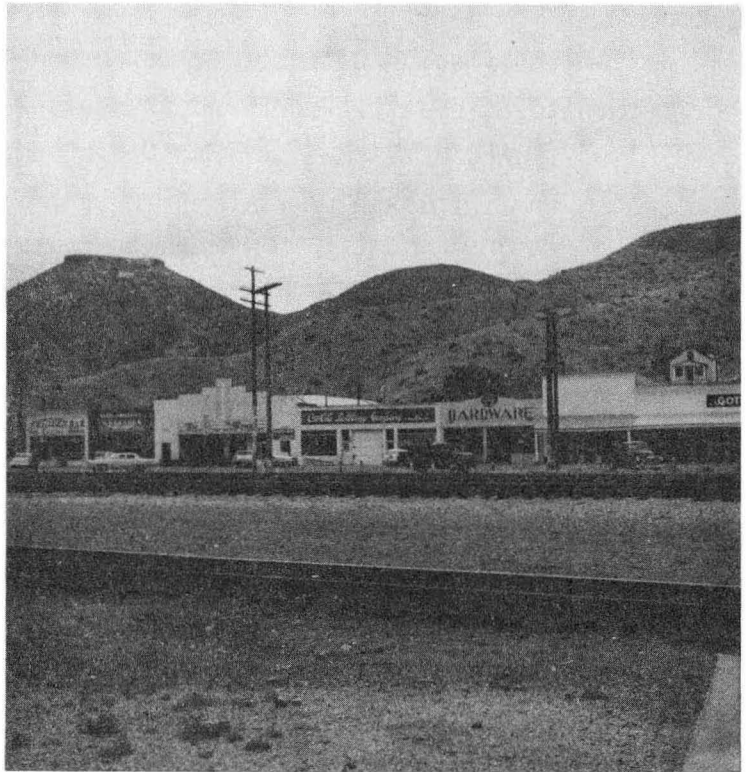

*Fig. 7d Lincoln County Court House
Pioche, Nevada*

6/6/42



*Fig. 7e Justice of the
Peace, Edgar L.
Nores*



*Fig. 7f Main St., Caliente, Nevada, Rex Theater,
left center*

Note added in September 1992

Attached is a sketch of our wedding that Helen wrote a couple of months after the event.

While observing our 50th wedding anniversary on June 28 and 29, 1992, Helen and I revisited Caliente and Pioche. Several pictures were taken of places that we visited first on June 6, 1942 (Figures 7g through 7k). The railroad station in Caliente is still there, serving limited rail traffic. The station master area now serves as Caliente city offices, the former waiting room is the city library, the area of the "Beanery" is now an art gallery, while the hotel lobby area is used for police headquarters. The upstairs hotel rooms are now city offices.

Finally, the Lincoln County Court House where we were married June 6, 1942 is relatively unchanged, including the office of the Justice of the Peace, in which we were married.

As an interesting postscript, Helen and I located in July 1992 after our return to Lafayette, Frank Anders who was so helpful on our wedding day in 1942. Now a resident of San Diego, Frank again was very helpful. He located and furnished us with photographs (Figures 7a to 7f).

Glenn and Helen Seaborg's Wedding, Summer 1942

We had quite a time getting married but also very amusing; in fact, we began to feel like a movie scenario before we got through. We got off the train in Caliente, Nevada, on Saturday morning, June 6, about ten o'clock with a great deal of confidence, without a care in the world and a feeling that we merely had to take care of a few details and we would then have been quietly married. Little did we realize what was in store for us! We first decided to check our bags, but Caliente had no checkroom. The telegraph operator finally told Glenn that he could leave our things in his place. We deposited our junk and proceeded out to look over the town and find the place to get a marriage license. Being a little coy, we strolled around looking for the place instead of boldly asking anyone. Since we couldn't locate the city hall or anything that remotely resembled same, we finally went in to the town telephone and asked the woman who operated it. She acted as though she had never heard of such a thing as a "city hall." We then asked where one could get a marriage license, to which she replied, "Why, from Evans Edwards" in tones that clearly indicated she thought us terribly stupid not to know that. Glenn asked her where Ev was, and she said, "Why, down around the corner next to the drug store." Here her tones indicated that it was the same place it had always been, what was the matter with us anyway. So we proceeded to Ev's to find him leaning back precariously in his swivel chair looking into space. We told him we wanted to get a marriage license. From Ev we learned that one could not obtain a marriage license in Caliente and that the closest place to get one was Pioche, which was some 25 miles north. Ev was most uncommunicative and didn't seem to have anything to offer in the way of a suggestion for us to get over there. At this point a woman came out. Like most women, she had romance in her soul, and she told us we could probably get a ride in the mail truck, told us where to find it and said it had not yet left. We thanked her gratefully and left .

Glenn went to find the driver of the truck while I went to buy a pair of tennis shoes. The town was nothing but dust, and of course, I had nothing but toeless shoes. When I came back I found him talking to a young man. The latter it turned out was a deputy sheriff and son of the telegraph operator where we had left our bags. Apparently the local inhabitants were somewhat suspicious of us and had asked the young fellow to check up on us. So he had come up to Glenn and asked, "Are you a teacher?" Poor Glenn, this was a horrible shock; he thought, "Surely it doesn't stick out all over me already," but he admitted he was. This was followed with, "Do you teach chemistry?" "Yes." After this cautious approach, the fellow admitted that he had just graduated from Cal majoring in chemistry [Glenn learned much later that the deputy's name was Frank White Anders], that Caliente was his home, and that he was there for the summer before taking a job in research laboratories in Washington this fall. Then he was very nice and offered to help us in any way he could; so he and Glenn went over to the town telephone to call Pioche to make sure we could get in the county courthouse if we got there after noon (since it was Saturday). A voice at the other end of the wire said of course someone would be there--didn't he know the county commissioners were meeting that afternoon? Then we piled into the mail truck and were off, via Panaca, for Pioche. We arrived about 12:40 p.m. to find the assistant county clerk waiting for us. She

told us that she would have been gone if Glenn hadn't called; so we felt very lucky. She made out our license and was more nervous than we were. By that time we were very calm anyway--prepared for whatever might come. I am sure we were beyond the point of surprise. Then she asked us if we wanted her to call the judge, and we asked her about a minister. It turned out there was only one in town; so she tried to locate him for us, but he was nowhere to be found. We decided we had better not take further chances and asked her to get the judge for us then. Well, nobody knew where the judge was; so she told us to get in her car and she would drive us to town to find the minister or the judge. (The courthouse was about a mile from the town itself.) When we got there, she told us to go have lunch while she hunted. We invited her to have lunch with us, but she insisted on our going ahead and that she would hunt. She told us which was the better restaurant in town and went off. When we were half through lunch, she came in to tell us that she had located the judge and to come to her car when we were finished eating. A few minutes later the judge came in and told us they were right across the street waiting for us. I shall never forgive Glenn (as I tell him as frequently as I have an opportunity) for practically telling the judge that we would be there as soon as he finished his apple pie, and he sat there and calmly finished. The rest of the day was comparatively calm after that. The judge was just like the country judge one reads about in books. He was very proud of his country and told us all about the mining there. He was rather cute. When he gave me the marriage license, he told Glenn to keep his hands off--that it was mine and told me not to let him have it. We got quite a kick out of it. Then we both forgot to pay him--after our having some discussion as to what one should give him .

Glenn and I were both convinced that had we not the good fortune to run into the two young women with romantic souls we would never have succeeded in getting married. The assistant clerk was a roly-poly good-natured person who told us that Pioche was not her hometown--Panaca was. (Panaca was 13 miles south). It turned out she was married to a sailor and had been going where he did whenever she could, but he went to Ireland last summer, and she had felt lonely and had come back to Pioche to work. She had been married eight years and apparently thought it was a very good idea.

We had to wait until 4:30 for the mail truck to take us back to Caliente; so we took a walk and proceeded up a hill and saw some beautiful scenery and got some sun. We then decided that the city folk may make suckers of the country people who come to town but that this is nothing to what the country folk do to the city guys. We met a man with a bunch of pictures of the Pioche High School band, and it seemed the band has just won some kind of an honor and that they would be able to do something else wonderful if only we bought one of the pictures. He told us that this was the only honor that had ever come to Pioche and put up a wonderful sales talk--what could we do but purchase a picture of the Pioche High School band, On the way back into town we met a very palsy-walsy fellow (slightly tipsy), but he wanted us to stop and have a cigarette with him. We gravely thanked him, told him we were very sorry we didn't smoke. This left him feeling very sad, and he assured us he wasn't mad and that we didn't have to have a cigarette with him. We loafed around and drank cokes until the mail truck started back, and we arrived back in Caliente about 5:30. So we say it took us all day to get married.

Confidentially, I was beginning to wonder if we were really going to get married, and Glenn doesn't deny that he conjured up these obstacles himself in the hope that he would get out of it at the last moment. The funny part is that we got married in Nevada to save time .



Fig. 7g Helen and Glenn Seaborg in front of Lincoln County Court House, Pioche, Nevada, June 29, 1992

Fig. 7h Helen and Glenn, June 29, 1992, in office of the former Justice of Peace where they were married on June 6, 1942, Lincoln County Court House, Pioche, Nevada



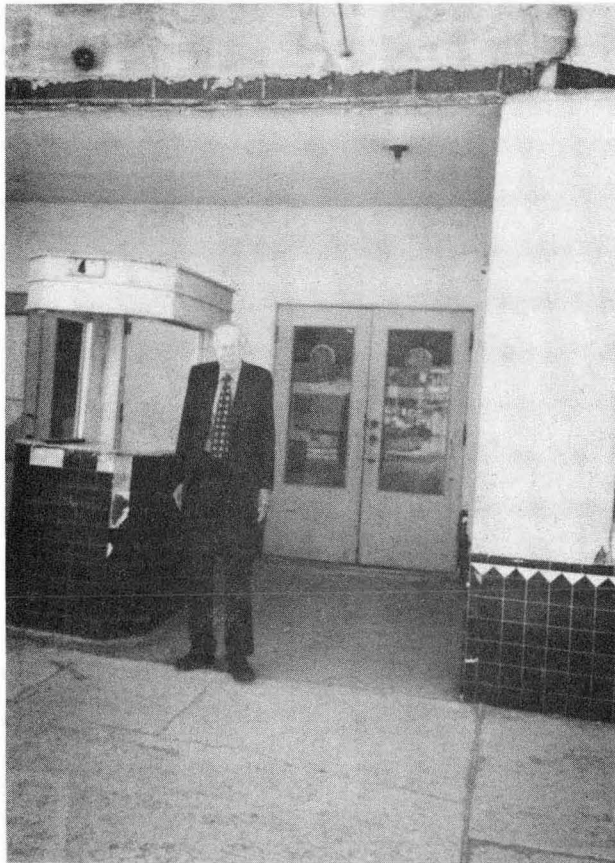

Fig. 7i Glenn in front of now abandoned Rex Theater, Caliente, June 29, 1992



Fig. 7j Glenn and Helen outside former office of station master (and telegraph operator), now Caliente city offices, old railroad station building, June 29, 1992



*Fig. 7k Helen and Glenn outside old railroad station
in Caliente, Nevada, June 29, 1992*

Tuesday, June 9, 1942

After spending June 7 and 8 on the train, Helen and I arrived in Chicago at 8:30 a.m. and were met by Iz Perlman. He drove us to our apartment on Woodlawn Avenue. Just as we arrived, a car full of people-- Gracemary and Charles Coryell and Milton Burton among them--stopped to greet us.

I went immediately to our labs in Jones Laboratory and to Eckhart Hall. My secretary, Mrs. Sullivan, handed me a sealed envelope. Inside was a revised notice of appointment from the Board of Trustees, University of Chicago, informing me that my salary has been raised by \$11.25 per month (from \$360 to \$371.25) and that my appointment as Research Associate is from April 20 to the end of this month (at which time it will be renewable for the next fiscal year).

6/9/42

On my desk was a copy of a letter from Compton to Allison. It was in regard to the administrative matter that Compton said he would resolve. Henceforth, Allison will head up all chemistry at the Met Lab. Responsible to him will be Spedding, myself, Latimer in Berkeley, Furman at Princeton and Rodden at the Bureau of Standards. Spedding will still direct the groups led by Boyd, Burton, Coryell and McCoy, as well as his projects at Ames. But the development of 94 chemistry at Chicago will be entirely in my hands—something Compton had assured me of earlier.

The letter also stated that Edward Teller is joining the Lab and will be attached to the theoretical group under Wigner. In view of the urgent need of help by Spedding on theoretical chemical problems, Teller will be assigned to the group working under Spedding for a major part of his time.

I phoned John Willard at Madison, Wisconsin, and he said he has decided to accept my offer to join my group here at the Met Lab.

Brown started work here as a Research Associate, as scheduled, on June 1 and has been outlining methods of separation of 94 from uranium and fission products by volatility methods. In talking with him today, I see that he is already convinced that this is the way to go into production, everything scaled up and using remote control. His argument is that the non-volatile 94 higher fluoride can be separated not only from the volatile uranium hexafluoride but also from a large proportion of the fission products due to the fact that the non-volatile higher fluorides of the fission products, in general, are water insoluble, whereas the non-volatile 94 higher fluoride is water soluble.

During my absence from Chicago Perlman initiated his study of the co-precipitation of plutonium with uranium peroxide. He discovered that 50-year 94 in tracer amounts can be precipitated quantitatively with the hydrated peroxide of +6 uranium ($UO_4 \cdot 2H_2O$) when aqueous uranyl nitrate is treated with an excess of dilute hydrogen peroxide. When he repeated his experiment, he found that 94% of the 94 is precipitated. He then set up an experiment to find out whether or not 94 will precipitate with uranium in the presence of lanthanum and concluded that lanthanum does not inhibit the carrying of 94 by uranium peroxide. Since the 94 is undoubtedly

6/9/42

in the +4 state it is not clear why uranium in the +6 state is such an effective carrier.

English followed this with an experiment to see if dilute hydrogen peroxide oxidizes 94 to the fluoride-soluble higher oxidation state (presumably +6 state) and found it does not do so. He also has completed his work on the uranium bombardment with 12 Mev deuterons at Washington cyclotron begun on May 18. His analysis shows that the yield of 50-year 94 is approximately 5×10^{-6} microgram per microampere-hour with the 12 Mev deuterons at Washington University, in contrast to 2.5×10^{-5} microgram per microampere-hour with the 14 Mev deuteron beam at Berkeley, a ratio of 1:5.

This work of Perlman and English was discussed in my report "Group I: Chemistry of 94" (CC-100) for the week ending May 30. In the following week ending June 6, further experiments were carried out by Perlman and English on the precipitation of tracer amounts of 94 by the addition of hydrogen peroxide to aqueous uranyl nitrate solutions; it was shown that the acidity of the solution must be controlled (pH must not be too low) and that partial precipitation of uranium does not bring down 94 quantitatively. Oxidation of 94 with ozone was investigated by Perlman in the search for an optimum oxidizing agent (whose reduction products are innocuous) for use in the lanthanum fluoride separation process of 94, but there were no definite conclusions. Perlman also commenced his study of 94 electroplating and showed that it is deposited quantitatively (from acetic acid-acetate buffer, pH 4.7-5.0) when in its oxidized form (with silver peroxydisulfate) but not when in the reduced state, in agreement with some previous findings of Gofman in Berkeley; this offers a potential method for the separation of 94 from fission products via an oxidation-reduction cycle. These results are reported in my report "Group I: Chemistry of 94" (CC-114) for the week ending June 6, submitted today.

In the laboratory today, Perlman was continuing his study of electroplating, Brown was busy with preparations for fluorination experiments, and English was continuing an experiment on the partial precipitation of uranium as UO_4 . James, Knox and Hill were assisting, James with English, Knox with Perlman and Hill with Brown. Orville F. Hill is a new man, who just started with us June 1, and whom we have decided should work

6/9/42

with Brown on volatility problems. Brown and Hill will work in the fume hoods just outside of Room 403 and across the hall from Room 403 and will also have some laboratory bench space (no. 3) in Room 404.

Compton brought Teller around to see me. He said Teller will be available for any help that I might request of him. With great confidence Teller volunteered to calculate anything I might need in my work. When I said that I doubt our chemical problems, such as the discovery of a suitable precipitation carrier for plutonium, are subject to solution by calculation, Teller disagreed and indicated that he could probably calculate the solution to any chemical problem that I might pose to him.

Although this is my first evening back in Chicago, I was scheduled to give Lecture IV of my course on nuclear chemistry, as usual, in Room 316, Eckhart. I covered the topics, nuclear cross sections and types of nuclear reactions. Coryell is taking notes at these lectures and, with my help, intends to have them transcribed and issued as a report at the conclusion of the series; this material should be useful for instruction of incoming Met Lab people. Last Tuesday, while I was in Berkeley, Spof English and Volney Wilson pinch-hit for me and lectured on counting equipment. English covered electroscopes and ionization chambers connected to electrometer circuits and to linear amplifiers. Wilson discussed Geiger counters, their mode of operation and uses.

The Planning Board met last Saturday, attended by Allison, Compton, Doan, Fermi, Hilberry, Moore, Spedding, Szilard, Wheeler and Wigner. In talking about the relationship of the Metallurgical Project to other projects, someone mentioned that it is possible all the projects will come under the supervision of the War Department. Compton announced that the Lab is being reorganized, with chemistry under Allison, physics under Fermi, engineering under Moore, with a supervisory outlook of the whole picture by Szilard and Wigner. He indicated that Seaborg should have 15 to 20 chemists working with him. Compton also said that we should not be backward in making out patent applications. Patents will be assigned to the U.S. Government. There is an understanding with the British that

6/9/42

all patents will be put into a common pool for use by both countries.

Wednesday, June 10, 1942

My second day back at the Lab was not so hectic, and I had an opportunity to visit with Orville Hill, who was hired as a Research Assistant by Stearns and fortunately assigned to my group; he received his Master's degree in chemistry from the University of Illinois last year. He is here only on a temporary basis as he expects to return to graduate school this fall. He told me an amusing story of his first day at the Met Lab, which occurred while I was in California. He had gone directly to the administrative office, where he announced that his name was Hill and that he was to report for work that day. He was warmly welcomed--much more so, he thought, than one arriving for a summer job should deserve. He started to stand in the long sign-up line, but someone told him to skip it and come along and meet Fermi, who was expecting him and with whom he'd be working. Since he wasn't aware of the nature of the project, he guessed he would be doing some analytical work for Fermi. It was not until after meeting Fermi and then hearing something about "the work at Caltech" that it dawned on him that here was a case of mistaken identity. It so happened that David Hill, the physicist, was also scheduled to arrive that day.

Hill went on to say that as soon as he was properly identified and processed, Coryell introduced him to the group. Coryell gave him a complete description of the project and its purposes and told him about the existence of element 94 and intentions to build pilot and production plants. The second day Coryell called him into his office and told him to forget everything he had been told--that his security clearance had not yet come through. But now it has, and he is privy to all our secrets.

Allison has organized a Laboratory Research Council for Chemistry, and this afternoon we met for the first time. There were four of us in attendance, Allison, Spedding, Teller and I.

A brief discussion of the isotopic assignment of the 50-year activity of element 94 took place. It seems that both the 50-year and 30,000-year activities fall on the Geiger-Nuttall curves for the actinium ($4n+3$)

6/10/42

family. This is to be expected for the 30,000-year activity, which has a mass number known to be 239. If the Geiger-Nuttall evidence regarding the 50-year activity is to be trusted, it would indicate a mass number 235; however, English's experiments suggest that the 50-year activity might be due to mass number 238, produced from U^{238} by a (d,2n) process followed by beta-particle emission.

Other matters discussed were (1) the future need to study the problem of producing metallic 94 from its compounds; (2) sending Dr. Hamilton to Mallinckrodt Chemical Company in St. Louis to look into the possibility of recovering UX_1 from residues to serve as a source of pure U^{234} for fission measurements; and (3) several experiments under way at Ames, including the separation of 94 from neutron-irradiated lumps of uranium metal and oxide, which is just getting under way.

Thursday, June 11, 1942

J. Robert Oppenheimer came to my office this morning, and although we are old friends, it was more than just a social call. After the resignation of Breit last month, Compton appointed Oppenheimer to succeed him. On the same day that I was getting married, Oppenheimer was in Chicago at an organizational meeting. John H. Manley, a physicist at the Lab who has been experimenting with such things as the diffusion lengths of thermal neutrons in water, was chosen as his assistant. At the meeting it was decided that Oppenheimer would preside over a group of theoreticians in Berkeley and Manley would direct experimental work here at the Met Lab. Their tasks will be to study fast-neutron reactions, which is a prerequisite to the design of an atomic bomb. Oppenheimer consulted me to learn more about the fast-neutron work of Gofman and Friedlander—they have been measuring the relative fast neutron fission cross sections of Pa^{231} , U^{233} , U^{235} , U^{238} and 94^{239} —and he will talk further with them when he returns to Berkeley. Gofman and Friedlander obtain their neutrons from a one-gram radium-beryllium source, whereas Manley uses deuteron-deuteron neutrons from the University of Chicago cyclotron.

6/11/42

Probably by now Latimer has received a copy of Compton's letter to Allison describing the new organization of the chemical program here. I wrote to Latimer about it, commenting that I find the present situation much more satisfactory than the previous one. I don't know if he is getting edgy about not receiving a letter of intention regarding the Berkeley program, so I assured him that from what I can gather the arrangement will go through as planned. Also, I informed him of Oppenheimer's visit and how it concerns Gofman and Friedlander, who will be Latimer's responsibility if the contract is approved.

My second letter went to Hamilton, whom I saw during my last afternoon in Berkeley. I told Joe that with regard to the ether extraction plant of the Mallinckrodt Chemical Company in St. Louis, they are starting to treat a ton of U_3O_8 per day. This should make it possible to extract UX_1 to produce U^{234} . I suggested that he might want to go there to look over the process but first should visit us to get authorization for the inspection.

Our Report "Properties of U^{233} " under the authorship of Gofman, Stoughton and me was issued today as Report CC-126. This covers our work at Berkeley and was written (dictated to Mrs. Sullivan) soon after my arrival in Chicago with the help of Gofman and Stoughton through correspondence. I had previously written an abstract of this report (Report A-153) while still in Berkeley. In this more complete report we describe the processes for the production and chemical isolation of our 3.8 microgram sample of U^{233} (Sample J) and our measurements of the growth of U^{233} in chemically isolated samples of the parent Pa^{233} , one of which led to an additional sample of U^{233} of 0.8 microgram. We describe our measurements on these two samples with our 300 mg radium-beryllium neutron source which have established the slow neutron fission cross section of U^{233} as about 1.3 times that of U^{235} . We also report that the growth experiments have established a half-life for U^{233} as 1.2×10^5 years and that our measurements on its alpha particles indicate a range of 3.1 ± 0.2 cm of air (at $15^\circ C$, 760 mm). We also report that our search for spontaneous fission in U^{233} using the 3.8-microgram sample indicates that the "half-life" for this process may be greater than 10^{14} years.

6/11/42

I have been appointed a member of the Engineering Council here and today attended my first meeting, along with Allison, Compton, Doan, Fermi, Hilberry, Leverett, Moore, Spedding, Wheeler and Wilson. We spent most of our time discussing the relative advantages of locating the atomic pile for producing 94 in the Chicago area or in the Tennessee Valley. Fermi thinks a rectangular area two miles long and one mile wide will be needed. Moore estimates that for a million kilowatt plant there must be a supply of water at least 140,000 gallons per minute, and Compton believes that 65,000 kilowatts of electrical power will be required.

During our discussion there were pros and cons expressed about associating with Lawrence's U²³⁵ separation plant. Compton noted that Lawrence wants to keep his calutron pilot plant close to the scaled-up production plant and on the West Coast. I pointed out that speed is essential in getting our atomic power plant built and operating, and there is really no reason for associating with the calutron project. Compton presented a chart listing 16 factors that should be considered before choosing between Chicago (Dunes area) and the Tennessee Valley (Elza area) as the site of the atomic power piles. According to Compton's weighing of the factors, Chicago is favored slightly; it was agreed, however, that it is difficult to make a stronger case for one as compared with the other. He outlined as a proposed schedule the building of piles of the following power levels: (1) 100 watts, (2) 100 kilowatts, (3) 100-100,000 kilowatts (helium-cooled pilot plant), (4) up to 1,000,000 kilowatts. There was general agreement that plants 2, 3 and 4 should be at the same site.

The afternoon meeting ran so late that Helen and I were terribly late to dinner at Harry and Adele Brown's at their apartment in nearby Hyde Park (5542 Blackstone Avenue). Then Harry and I had to rush off to our regular Thursday evening Research Associates meeting. Later we rejoined our wives, bringing along some other guests.

Walter Jilek, a high school graduate, started work today as a Laboratory Helper in my group. I will have him serve as an aide to Covey, who is doing odd jobs of every description for all of the fellows in my group.

Friday, June 12, 1942

Arthur H. Jaffey came to my office around nine o'clock this morning and talked to me about a job. He received his Ph.D. in physical chemistry from the University of Chicago last year and is now working with Urey at Columbia University on his U^{235} project. Because he already has a security clearance, I was able to enlighten him about element 94 and its potentialities and how we plan to produce and separate kilogram quantities. He appeared to be shocked by the news. But that is not unusual, and I take delight in observing how people react when they first hear about plutonium and the major role it might take in our war against the Germans. Some stare in disbelief; some are dumbfounded and are glassy-eyed or open-mouthed; others become excited and pour out a torrent of questions. Jaffey has just the qualifications in a chemist that I am seeking. I said he could come to work with the group whenever he likes, and he agreed to start about July 1. After he left the office, Perlman, who had been in the office during the interview, expressed equal enthusiasm about our new colleague.

Hamilton wrote, asking about the possibility of Roderick Craig coming to work for me. Craig has a Ph.D. in biochemistry, is an assistant professor of insect physiology at Berkeley and has worked for three or four years with radioactive materials and their measurement. I also heard from Cefola, who says he will leave New York for Chicago on June 15. We have ordered most of the equipment listed by Benedetti-Pichler for ultra-microchemistry and expect it to arrive in Chicago very soon.

English and James performed an experiment today to test the volatility of a chloride of 94 at temperatures at which germanium chloride ($GeCl_4$) volatilizes—its boiling point is $83^\circ C$. They distilled about 3 mg of germanium from a mixture of hydrochloric and sulfuric acids to which tracer amounts of 50-year 94 alpha activity were added. The distillate was collected in an ice bath. Lanthanum was added as a carrier to both the distillate and the dissolved non-volatile residue, lanthanum fluoride precipitated and its alpha activity determined. It was found that the lanthanum fluoride from the distillate contained no alpha activity,

6/12/42

whereas about 75% of the alpha activity was recovered from the residue in the distilling flask. It can be concluded that ^{94}Cl is not volatile from aqueous solution at relatively low temperature.

This evening Helen and I went dancing to the music of Eddy Duchin and his orchestra in the Empire Room of the Palmer House.

Saturday, June 13, 1942

I sent a letter to my friend Saul Winstein and told him that if he would be willing to take a leave of absence from the Chemistry Department at UCLA, I would certainly like to have him join me here. Another letter went to Cunningham in Berkeley; I said that we are expecting him July 1 and that I am looking forward to his arrival. A third letter went to my former roommate, Donald E. Hull, expressing my pleasure at the possibility he might join Willard F. Libby at Columbia to work on barrier materials for the ^{235}U gaseous diffusion process.

Sunday, June 14, 1942

I had the pleasure of exploring Jackson Park with Helen this afternoon. We walked there from our apartment and then walked around in the Park. We noticed that the golf course there was very crowded.

Monday, June 15, 1942

Saturday there were only nine of us in Group C-I: Brown, Covey, English, Hill, James, Jilek, Knox, Perlman and myself. Today there are twelve. Koshland (a Research Assistant) from the Shell Development Company, Willard (a Research Associate) from the University of Wisconsin, and Magel (a Research Associate) from the University of Illinois all started today; they will work at the laboratory benches in our large Room 404. Equipment is coming in now, and there is plenty of work for everyone.

6/15/42

Willard committed himself to be with us only through the summer months, but I am confident he will continue with us after he learns the importance of our work. He asked if he may bring in Elton Turk as his laboratory assistant, and I was quite agreeable. Turk is getting a Master's degree in chemistry this month at the University of Wisconsin. Also at Wisconsin is Truman P. Kohman, who is about to take his Ph.D. Willard thinks he would be valuable to me because of his considerable experience with radio-tracer techniques. I intend to invite both these men to join our group.

With the arrival of Willard, Magel and Koshland we shall commence investigations in two methods for the separation of 94 from uranium and fission products that have been impossible to start because of the lack of manpower. I am asking Willard to work on adsorption methods, emphasizing inorganic adsorbents because these should be affected less by radiation than organic adsorbents; I shall have Turk work as his assistant if we succeed in adding him to our roster. And I am asking Magel, with Koshland as his assistant, to work on solvent partition methods for the separation of 94. Willard (and Turk if he comes) will work on one side (the west side) of the long laboratory bench (no. 4) in Room 404, and Magel and Turk will work on the other (the east side) of that bench; they will also have the use of the excellent fume hoods in that room. Magel will have his desk in the area between laboratory benches 3 and 4, and Willard's desk will be located in the area between laboratory benches 4 and 5.

On the basis of Hamilton's letter of last week I wrote Roderick Craig at Berkeley inquiring about his availability to join my group here on a leave-of-absence basis.

According to today's newspaper, 585,000 foot-marchers turned out for a parade yesterday that lasted 15 hours. It was the most gigantic in Chicago's 109 years of history and was in observance of MacArthur Day, United Nations Day and Flag Day.

Tuesday, June 16, 1942

Cefola arrived for his first day of work as a Research Associate. I will have him work in Room 405, converting this into our room for ultramicro-chemistry where Cunningham will join him when he arrives on July 1. As soon as the microchemistry apparatus comes I will probably have Cefola run through the lanthanum fluoride process, or some phase of it. It will be interesting to see what the fluoride does to the micro glassware and what steps can be taken to protect it.

My weekly report, "Group I: Chemistry of 94," for the week ending June 13, 1942 (report CC-125), submitted today, concerns the non-volatility of 94 chloride and the fluorine method for separating 94. The experiment by English and James to look for a volatile halide of 94 that can be distilled from an aqueous solution of hydrogen halide is described. Apparently from the result, 94 is not volatile as chloride from an aqueous solution at relatively low temperatures. Brown suggests a fluorine method for separating 94 from uranium and fission products based on the supposition that 94 does not form a volatile fluoride under typical conditions for forming volatile UF_6 ; the Pu, soluble in its oxidized state, will be separated from the insoluble, non-volatile, fission product fluorides by leaching with aqueous solution. He suggests that to test the scheme it will be necessary to extend the experiments on the volatility of 94 fluorides to temperatures of 700° - $800^{\circ}C$.

Brown and Hill have completed construction of their fluorine generator and started their first experiment today working in the fume hoods in the entry area of Room 404 and just outside of Room 403. Their aim is to test the fluorine volatility method for separating 94 outlined in our last weekly report (CC-125). They fluorinated, at about 250° - $350^{\circ}C$, a mixture of uranium and fission product elements (tellurium, barium, lanthanum, cerium, selenium, antimony, silver, rubidium) containing tracer 50-year 94, to test the behavior of the fission product elements and whether the unvolatilized 94 higher fluoride can be separated, by leaching with aqueous solution, from the non-volatile fission product elements. They find, however, that the unvolatilized 94 fluoride does not leach out in a

6/16/42

6 N HF solution. As their working space in Room 404 they are using laboratory bench no. 3, and Brown has set up his desk against the wall at the south end of the area between laboratory benches 2 and 3.

I gave Lecture V of my evening course on nuclear chemistry, concluding the summary of nuclear reactions and taking up beta decay, K-electron capture and nuclear isomerism.

Wednesday, June 17, 1942

Continuing their experiment of yesterday Brown and Hill leached the non-volatile 94 fluoride residue with a solution of potassium peroxydisulfate plus silver ion, and again they find that the 94 remains behind with the non-volatile fission product elements. This indicates that either the 94 is reduced rapidly by water or has a peculiar higher fluoride that is water insoluble. In order to check the previous results (the experiment Brown performed while still at Johns Hopkins University in which he and Perlman found that 94 does not volatilize with fluorine at 450°C), Brown and Hill fluorinated the same UF_4 -94 mixture at 250°C and at 750°C and they find again that the 94 does not volatilize. The fluoride volatility process can, of course, be modified to recover the 94 from the non-volatile fluoride residue by dissolving it in acid and using the lanthanum fluoride oxidation-reduction cycle.

Perlman and Knox performed another experiment testing the capability of ozone to oxidize 94. Today they took special pains to dry the oxygen before allowing it to enter the ozonizer (a commercially built instrument in which oxygen is passed along concentric electrodes between which a 6,000 volt silent discharge is maintained); this results in the production of ozone free of hydrogen peroxide which apparently reduces the ozone and 94 and prevents complete oxidation of 94 by ozone. The oxygen-ozone mixture from the ozonizer was bubbled through a solution containing 50-year 94 tracer activity and some Ce^{+3} - Ce^{+4} in 2 N H_2SO_4 at 80°-90°C for 2-3 hours. Subsequent analysis by co-precipitation of 94 with lanthanum fluoride, in which no 94 was found, and measurements on the filtrate, in

6/17/42

which the 94 was found, indicate that 94 is quantitatively oxidized by ozone under these conditions.

I had lunch with Perlman and Brown in the Hutchinson Commons. I find this a more convenient and informal place to have a quick lunch than the Quadrangle Club; the Club, of course, is a more appropriate place for my more official lunches with visiting scientists.

The American Chemical Society, University of Illinois Section, has invited me to speak at Urbana on a topic of my choice. I replied, saying I would like to speak on the application of artificial radioactivity to chemistry, biology and medicine, and suggested October as the best time for me. This will give me an opportunity to meet new people and will be especially useful in case I need to do more recruiting by then.

Today is the start-up for our neutron bombardment of the 300 pounds of UNH, furnished by Prestwood of the Berkeley group, at the Washington University cyclotron. It is scheduled to run for a total of about 50,000 microampere-hours.

Thursday, June 18, 1942

Brown and Hill analyzed the various fractions from Tuesday's fluoride volatility experiment and find that, as expected, the tellurium, selenium and antimony, as well as the uranium, are in the volatile fraction, while the other elements are in the non-volatile fraction.

The Laboratory Engineering Council meeting was held today, which I attended along with Doan, Fermi, Leverett, Moore, Spedding, Wheeler and Wilson. Our principal concern was how to design a pile for 94 production. Fermi, Spedding and I got into a discussion of a 50,000 kw pilot plant that will produce 3 kg of 94 every two months and also will expose uranium on the outside to produce 94 for experimentation. Fermi said that there is a need to take out a uranium column (from a few specially constructed columns) from the pile, say once a week or so, for chemical experimentation.

6/18/42

Wilson brought up the problem of cooling such a column and I was concerned about its radioactivity, there being too much for ordinary techniques of the chemist, even in the first uranium column removed. Wheeler cited Wigner as saying that 20 cm of lead will be needed for shielding once a pile is operating.

There was considerable discussion about uranium-to-carbon ratios, lattice spacing, neutron escape, and diffusion of fission products from the uranium columns into the graphite. On the subject of batch removal versus continuous operation, Moore gave three alternatives: (a) Let pile run, burn up or throw away graphite. Then take all the uranium to the chemical extraction plant. (b) Remove all the uranium and 20-30% of the graphite, process uranium and restack or reload. (c) Continuous operation, with machinery to load or unload uranium in cartridges. He thought sufficient graphite should be available to construct at least three piles. Fermi favored running a pile indefinitely if poisoning doesn't stop it. Spedding was bothered about how to handle graphite with fission products deposited in it, and my solution was to flood the whole pile with HCl gas, followed by water. Next week we will take up the topics of cooling and circulating powder as a means of control.

I wrote to Latimer (1) passing on the rumor that the Government may give us the final word on the awarding of the July 1 contract in about 10 days and assuring him that such last minute action is normal; (2) expressing disappointment that Professor Lewis will not be able to come to Chicago this summer to participate in our Chemical Council meetings; and (3) describing some work under way in Boyd's group on a method for removal of Ux_1 from uranyl nitrate solutions by adding adsorbents. Getting pure U^{234} for fission cross section measurements is still of interest to our project.

I received a letter from Winstein in reply to my June 13 letter indicating that he possibly could come to Chicago in August or October but that decision would be up to the University of California administration.

Friday, June 19, 1942

English and James performed an experiment to determine if 50-year tracer 94 distills with osmium tetroxide from nitric acid solution. The osmium tetroxide was all distilled from the solution with the help of a slow stream of air and collected in sodium hydroxide solution. No 94 alpha particle activity was found in the distillate, again indicating that the oxide of 94 is not volatile.

In a reply to Winstein I expressed regret that he will not be able to join us July 1. I urged him to take a job with us from August 6 to October 3 on a trial basis to see if he would like to stay on. A few such arrangements have been made, I said, because we are practically certain that no one will decide against staying at the end of such an interval. I wish there were something else I could do to persuade him to come.

I sent Hamilton a telegram stating that arrangements have been completed for his visit to Mallinckrodt Chemical Company in St. Louis to check the availability of UX_1 as a by-product from their ether extraction process for purification of uranium. I also told him we are interested in employing Craig, the insect physiologist he recommended to me.

The neutron bombardment of 210 pounds of UNH in the Berkeley cyclotron ended today with a total of 40,000 microampere-hours. Wahl will work up the material to isolate 94^{239} in about a month after most of the radioactivity has died away.

Helen and I dined with the Perlman and young Judy at their apartment on Drexel Boulevard. The food and talk were enjoyable; it was a good way to end the work week. Iz and I arrived here two months ago today.

Saturday, June 20, 1942

Willard started his first experiment today, working at laboratory

6/20/42

bench no. 4 in Room 404. In line with my suggestion that he investigate adsorption methods for separating 94, with emphasis on inorganic adsorbents so as to minimize the radiation problem, he is commencing such work. He made a number of practice experiments carrying 94 with lanthanum fluoride, then commenced to test the absorption of 94 by coconut charcoal.

I also had a discussion with Cefola, who is busy assembling equipment preparatory to starting his ultramicrochemical work on the chemistry of 94.

The Metallurgical Laboratory Planning Board met today, attended by Compton, Doan, Fermi, Moore, Teller, Wheeler and Wigner. The discussion centered around military aspects of the fission bomb. Compton outlined the mission of the Met Lab: to provide element 94 for the production of atomic bombs and possibly as fuel for atomic power plants for the Navy. Even radioactive by-products (fission products) might give us some military advantage. Furthermore, he stressed that we should be thinking of countermeasures to be used in atomic warfare, such as the detection of chain-reacting piles and fission bombs.

Compton repeated a conversation that ensued between him and Wigner on a possible schedule of the Germans. Like us, they have had three years since the discovery of fission to prepare a bomb. Assuming they know about 94, they could run a heavy water pile for two months at 100,000 kw and produce six kilograms of it; thus it would be possible for them to have six bombs by the end of this year. On the other hand, we don't plan to have bombs in production until the first part of 1944. No doubt the Germans favor heavy water because their graphite would not be free of boron, which would inhibit the chain reaction—they do not have access to petroleum coke for graphite production as we do. One clue why the Germans may be using heavy water is that they vigorously attempted to prevent the escape of heavy water from Norway and France. Compton mentioned that there are rumors of such a going atomic power plant operated by Germans. Since the Germans are instructed to find out what we are up to, why is it that we have no more definite signs of their interest? Szilard has made a suggestion that a physicist be sent to Germany to locate and

6/20/42

destroy enemy piles if they exist, which has now been transmitted to Washington.

Wheeler was of the opinion that it might be easier to locate a German plant through personal contacts, say if James Franck could be enlisted for the job. Fermi and Wigner agreed, and Wheeler then suggested that Franck or one of those present be sent to Switzerland. When Teller replied how dangerous that mission might be and that the candidate should be not only willing but eager, Fermi replied that we should interview two or three trusted German physicists in this country for their ideas.

There was considerable discussion about detectors—the kind that might signal the presence of dangerous amounts of radiation from the products of a nuclear explosion—and about ways of measuring neutron emissions from power plants and bombs to reveal their presence. Wheeler said it would be practically impossible to detect a power plant from an airplane by the neutrons given off, and Compton estimated the detectable range of gamma rays as several hundred meters. Fermi thought it would be impossible to detect a plant at a distance of several miles.

Sunday, June 21, 1942

Helen and I took a walk in Jackson Park in the afternoon.

Monday, June 22, 1942

I have a new secretary today—Mrs. Myrtle Kvidera, who has taken Mrs. Sullivan's place. She will have as her office the outer part of Room 403 in Jones Laboratory, with a partition separating this area from the inner area where Perlman and I share an office.

Hamilton visited me and we discussed the results of his meeting with John R. Ruhoff of the Mallinckrodt Chemical Company in St. Louis over the weekend. There seems to be an excellent opportunity for extracting large

6/22/42

amounts of UX_1 from some of the uranium purification residues, particularly after subjecting the residues to a second or third ether extraction.

President Roosevelt has approved the whole atomic bomb program. So I was informed today when I talked to Compton about the status of the Berkeley contract. He said the Berkeley project can now go ahead on the scale asked for and that Vannevar Bush will send Latimer the official letter of intention for his project shortly after July 1.

Tuesday, June 23, 1942

English and James ran a number of experiments to determine if the oxide of 94 distills with osmium tetroxide out of nitric acid solutions that have strong oxidizing agents present. They find that no 94 distills with the osmium tetroxide even when the oxidizing agents bromate plus Ce^{+4} ions are present.

Allison held a meeting of the Laboratory Research Council for chemistry. Besides myself, others present were Burton, Coryell, Davis, Fermi, Spedding, Teller and Wheeler. We spent the time discussing a single problem: how to study the diffusion of fission products from uranium to graphite, which is to be expected in a working pile. Spedding and I are supposed to report next week on an experiment to heat irradiated uranium to successive temperature levels and measure the radioactive gas that is released.

"Report of Week Ending June 20, 1942, Group I: Chemistry of 94" (report CC-136) was submitted today. We report the recent results of Perlman and Knox on the electroplating of 94. The results show that plating is quantitative using a bicarbonate plus carbon dioxide buffer with the 94 first placed in its upper oxidation state with peroxydisulfate in the presence of silver ion catalyst; an acetate buffer continues to give poor results. We report their experiments with ozone as an oxidizing agent in which oxidation of the 94 is complete when dry oxygen is used in the ozonizer and cerium ion is used as a catalyst. We also report the

6/23/42

results of Brown and Hill, testing the feasibility of the fluorine method for separating 94 as described in last week's report, which show that 94 does not extract with HF from the residue remaining from UF_6 volatilization, but remains with the insoluble fluorides. Therefore it is suggested that the scheme proposed in last week's report be changed to provide for dissolution of the 94 and rare earths in sulfuric acid followed by oxidation of 94 and precipitation of the rare earths as fluorides.

I received two letters from Craig, the first saying he would like to join my group, starting August 15; and the second, written a few hours later, saying after a conference with Claude B. Hutchison (Dean of the College of Agriculture), Lawrence and Latimer, it has been decided he should remain in Berkeley and work on some aspect of the project there.

I wrote to Latimer. I sent him Compton's good news about the Berkeley contract and letter of intention. Other matters concerned the importance of continuing the preparation at Berkeley of 7-day U^{237} , which is needed by us periodically and by Stoughton in Berkeley, and the notification from Craig that he will be unable to join my group. I told him that we are beginning to cover quite a lot of ground here in Group C-I and that there are a number of aspects of the work I hope to discuss with him when he visits Chicago next month.

I dictated another letter, this one to Ruhoff at Mallinckrodt, concerning yesterday's disclosure by Hamilton that cotton is used in the filtration processes. I asked that the cotton be saved to test whether or not it is absorbing some of the UX_1 .

I am continuing to find the cafeteria in Hutchinson Commons a convenient place to eat lunch, and usually a number of us from Jones Laboratory walk together the short distance to eat there. Today our luncheon group consisted of English, Brown, Cefola, Covey and me.

Lecture VI of my evening course on nuclear chemistry was given at 8:30 in Room 316, Eckhart Hall, as usual. I reviewed and expanded on various points of last Tuesday's lecture and then took up internal conversion

6/23/42

and the experimental study of decay processes. After the lecture many of the attendees and I joined our wives at the Tellers' apartment at 61st and Kimbark Avenue for a relaxing hour or two.

Wednesday, June 24, 1942

Perlman and Knox performed an interesting experiment on the electro-deposition of 94 today using the 50-year 94 tracer. Starting with 94 in the reduced state, electrolysis was carried out in the bicarbonate buffer medium for about 2 hours leading to the plating out of 13% of the 94 on the cathode. Then by carrying of 94 with lanthanum fluoride they found that 61% of the original 94 had remained in the electrolytic liquor in the reduced form and, following reduction with SO_2 , found another 25% of the original 94 was carried by lanthanum fluoride indicating this much had been oxidized during the electrolysis. This indicates that 94 was oxidized during the electrolysis to the extent of at least 25% and probably also to the additional extent of 13% since the electrodeposition seems to occur via an oxidation step.

Hamaker wrote from Berkeley to say that it would not be necessary to send him an ozone generator because they have been able to modify one that happens to be on hand. He described experiments already carried out that test the effectiveness of ozone (using Ce^{+3} - Ce^{+4} and Ag^{+} - Ag^{+2} catalysts) and chlorine as oxidizing agents for 94, some of which have proven quite successful.

Tonight Shep Fields and his orchestra opened at the Starlit Beach walk at the Edgewater Beach Hotel; so Helen and I traveled by Illinois Central and elevated trains to go dancing to Shep Fields' "rippling rhythms."

Thursday, June 25, 1942

I attended a meeting of the Engineering Council along with Allison,

6/25/42

Doan, Fermi, Leverett, Moore, Szilard, Teller, Wheeler and Wilson. The discussion centered around cooling the 100,000 kw pile, which has been proposed for the manufacture of element 94, by circulating hydrogen or helium through it. Liquid cooling has been ruled out for the present because of potential chemical action, danger of leaks and difficulty in transferring heat from oxide or carbide. Some of the participants preferred hydrogen to helium for cooling, but I pointed out that hydrogen would give a reaction with graphite to form methane, and this would certainly, and quickly, tear the pile apart. Teller chimed in, saying that radiation would catalyze such a reaction. There was general agreement to use helium. However, helium cooling presents difficulties because high pressures are required and because the helium will become highly contaminated with radioactivity unless pipes are used to contain it.

Considerable attention was paid to methods for removing fission products from circulating helium gas, such as spraying, use of cold traps, the Cottrell process, and glass wool dipped in oil. Fermi thinks that 99% of the fission products will remain in the uranium. Whatever method of fission product removal is used, I reminded them, one must consider the penetrating radiation from 300-hour barium, which is built up fast because of its short-lived precursor.

Perlman and Knox repeated yesterday's experiment with an electrolysis time of 2-1/2 hours. This time they find 11% of the original 94 in the electrolytic deposit, and in the electrolytic liquor they find 31% in the reduced and 58% in the oxidized form. This again suggests oxidation of the 94 is taking place during electrolysis, probably as a prelude to electrodeposition.

There is a phase of work on 94 that is not being emphasized by my group here in Chicago, and it occurred to me that C. S. Garner and Norman A. Bonner in the Chemistry Department at Berkeley might take time out from their work with ores to help us. (They are engaged in the search for naturally-occurring 94 in uranium ores.) So I wrote a letter to Garner to this effect, saying that I have in mind an investigation designed to establish more accurately the value of the oxidation potential for the oxidation of 94 from its lower (fluoride insoluble) to its higher (fluoride

6/25/42

soluble) oxidation state. The plan, I said, would be to equilibrate 94 tracer with aqueous solutions of various oxidizing agents including ozone, periodic acid, bromate, permanganate, dichromate, peroxydisulfate and chlorine. After equilibrium has been established, the amount of 94 that remains in the reduced state would be determined by precipitating it with lanthanum fluoride in the regular manner.

I wrote a letter to Gofman in Berkeley, informing him that his one-gram radium-beryllium neutron source is now ready, but the supplier will hold up shipment for a week or two while testing for leakage. I wondered why a day shouldn't be sufficient, but apparently they have their own methods, and not too effective at that. I asked him to write up his electrolysis experiments to be circulated as a Chicago Chemistry (CC) Report. I said that only about ten persons would see it, but it would be worthwhile at this time.

Friday, June 26, 1942

In experiments today, yesterday and the day before Brown and Hill have tested the behavior of short-lived fission products in their volatility process. In a number of experiments they bombarded uranium tetrafluoride for about an hour with slow neutrons at the University of Chicago cyclotron. They then fluorinated the neutron-irradiated uranium tetrafluoride and found that about 50% of the fission product beta-particle radioactivity is removed with the volatile uranium hexafluoride.

English and James repeated their experiments to test the volatility of the oxide of 94 using ruthenium tetraoxide, rather than osmium tetraoxide, as carrier; these distillations were carried out at higher temperatures in the presence of nitric acid plus perchloric acid. No 94 distills over with the ruthenium tetraoxide either in the presence or absence of the oxidizing agents bromate plus Ce^{+4} ions.

In a letter to Wahl in Berkeley I said that for a number of experiments contemplated here for the very near future we will need some neutron-

6/26/42

bombarded UNH with as high a specific activity as possible, and that we are primarily interested in the activities with half-lives of the order of weeks or months. I asked if he would be willing to dig out a sample of 50-100 grams from his 40,000 microampere-hour neutron bombardment of UNH, preferably near the beryllium target, and send it to us.

An article in today's newspaper says that the United States is advancing plans for a second front in Europe by establishing a European theater of operations, led by Major General Dwight D. Eisenhower, considered the ablest young officer in the U.S. Army. This new conduct of the war is thought to be the outcome of Prime Minister Churchill's current visit here with President Roosevelt.

Saturday, June 27, 1942

Following a week of preparation of solutions, samples, etc., Willard undertook batch experiments today with 50-year 94 tracer that show 94 (lower oxidation state) to be well adsorbed by Fuller's earth (99%), silica gel (68%), aluminum oxide (96%), Norit A (100%). His experiments also indicate that tracer quantities of 94 (lower oxidation state) can be removed to the extent of 50% from 10% UNH solutions, while less than 1% of the uranium is adsorbed, by both silica gel and aluminum oxide.

I attended a meeting of "Group Leaders and Planning Board." Others present were Allison, Anderson, Burton, Compton, Coryell, Doan, Fermi, Hilberry, Manley, Mitchell, Moore, Perrin, Spedding, Stearns, Szilard, Teller, Whitaker, Wigner, Wilson and Zinn.

Compton opened the meeting with a pep talk asking us to go ahead with all vigor possible. He said our aim the past half-year has been to investigate the possibilities of producing an atomic bomb—now we have the responsibility to proceed from the military point of view on the assumption it can be done and we can assume we have a project for the entire duration of the war. He told us about the continued emphasis on secrecy and that only about six men in the U.S. Army are permitted to know what is going on, including Secretary of War Henry L. Stimson and two construction

6/27/42

experts, General Brehon B. Somervell and Brigadier General Wilhelm D. Styer. Styer will be in charge of the production plants and Compton will have responsibility for research and pilot plant development as in the past. Hierarchy is this: Met Lab, University of Chicago, OSRD, U.S. Army; we at the bottom, of course. The Navy is staying out of it; later they hope to use atomic power for driving their ships—this aspect is essentially a by-product of our present work. Our program is to first demonstrate the feasibility of the nuclear chain reaction in uranium with a one-watt pile, then to build a pile (pilot plant) to start up at 100 kw to run up to perhaps 10,000 kw (or even up to 100,000 kw by some good luck) to produce 94 for chemical work, with work on the ultimate 94 production plant to go on simultaneously. The pilot plant will be under the control of the Met Lab and will be built near Chicago. It is hoped to have a contractor assume responsibility for the production plant. A number of the people present expressed great concern about working for an industrial contractor because of their fear that this would not be a compatible environment in which to work. There will be no laboratories built in connection with the pilot plants, but laboratories will be allowed in connection with the production plant. Moore and his staff will be transferred to the Met Lab to form the nucleus of our engineering staff. We were also told that Professor Schlesinger of the University of Chicago Chemistry Department now has an assignment bearing directly on the work of Urey and Lawrence (who are working, respectively, on the gaseous diffusion and magnetic field approaches for the separation of U^{235} from U^{238}). There was considerable talk about our being absorbed into the Army and what the advantages and disadvantages might be. There were vigorous objections from most of the people present. Compton told us that in a meeting with Conant and Bush, they remarked that Army pay would be lower and Bush had replied that it is up to us to make sacrifices. We were told that Ruhoff of Mallinckrodt is being inducted into the Army. Compton concluded the meeting by noting the Army fears enemy planes might fly over the pilot plant site and perhaps the fence should be concealed by trees.

Sunday, June 28, 1942

Helen and I visited the Museum of Science and Industry. Then Hamilton spoiled the day somewhat by phoning tonight from Washington, D.C., to say that the Berkeley 60-inch cyclotron has a leak in the D's, which must be pulled. It is a major breakdown and threatens our work. He expects to see us tomorrow, as he is on his way to St. Louis to take care of his bombardment there.

Monday, June 29, 1942

During the last week Perlman and Knox have been studying the amount of short-lived fission product beta particle activity that co-precipitates with uranium peroxide under conditions where 94 is well carried. Using UNH bombarded with neutrons at the University of Chicago cyclotron, they find about 20-30% of the fission beta particle activity is carried with not too much effect of the time after bombardment at which the precipitation is made.

Stoughton wrote from Berkeley notifying me that he is sending two samples of thorium fluoride (containing 7-day U^{237} as tracer) for use in testing the U^{233} -thorium fluoride volatility separation process which we discussed when I was in Berkeley the first of this month. Shortly after receiving the letter, the samples themselves were delivered and Brown and Hill set to work fluorinating them. They finished tonight and we airmailed the fractions back to Stoughton.

In view of the breakdown of the 60-inch cyclotron, I sent a letter to Kamen at Berkeley to find out when Stoughton's big bombardment of thorium (to make U^{233}) will start. I added a postscript, "Helen and I got married on the scheduled day in Nevada after some difficulties which you may have heard about. However, it was much more fun that way than if everything had gone smoothly. We are finding Chicago not too unpleasant; in fact, we kind of like it." For a Californian, I think I am being very generous. Later in the day, there came a telegram from Kamen telling of the disaster.

6/29/42

He said the cyclotron will be down for several weeks.

Hamilton arrived as promised, and we spent the evening at home agonizing over the breakdown. It is really a major catastrophe. It may affect the whole program here.

I bought a copy of the recent book by Anton Alexander Benedetti-Pichler, Micro-Techniques of Inorganic Analysis, which gives an excellent description of, and instruction for, work in chemistry on the microgram scale.

We are expanding our space a bit to include a large, unfinished area nearby on the fourth floor of Jones Laboratory. This is a storage room, a sort of "attic," and opens onto an outdoor space on a portion of the roof of the third floor. This space will be well suited for the work that we plan on ether extraction and recrystallization of large batches of UNH. Covey has helped put this area into shape for this work and will use a portion of it, the entrance through Room 411, as part of his own quarters. We have found that Room 404 is too crowded to accommodate this activity, and in looking around we found this extra space and were fortunate in obtaining the permission of the University of Chicago Chemistry Department to use it.

Tuesday, June 30, 1942

Brown and Hill received a molybdenum target from Berkeley which has been bombarded with 16 Mev deuterons for 100 microampere-hours (on June 17) to produce radioactive element 43. They will use this to test the volatility of the fluoride of 43.

I answered Kamen's telegram, explaining that the delay in Stoughton's bombardment is a serious blow to the program, especially because the material must go through a long, tedious chemical procedure after the bombardment; thus we don't get a final sample suitable for measurement until several months after the bombardment. "This breakdown," I said,

6/30/42

"delays the program in another way also. I have had to interrupt the bombardment at St. Louis in order to allow Joe Hamilton to get his own bombardment there." The letter ended on a pleasant note; anyway, I don't think my carping will help fix up the cyclotron any faster. I asked that he keep me in touch with developments.

In our "Group I: Chemistry of 94" report (CC-126) for the week ending June 27, 1942, we describe Perlman's experiments, which show some evidence for the postulate that 94, when initially present in its lower oxidation state, must first be oxidized at the anode to its upper state before it is reduced and deposited as an oxide at the cathode. A corollary of this proposed mechanism is that 94 would be prevented from depositing if its anode oxidation could be prevented; this might form the basis for a separation of 94 from uranium as well as from other elements. Some preliminary experiments of Brown are outlined. Results indicate that when a mixture of UF_4 and fission products is fluorinated, about 50% of the beta-particle activity of the relatively short-lived fission products is removed with the UF_6 . The following substances have been fluorinated at $300^\circ C$, in continuance of the fluorination of elements that might result from uranium fission: sodium bromide, potassium iodide, ruthenium metal; it was found that the bromine, iodine and ruthenium were completely volatilized. Preparations are now under way for experiments with long-lived fission products, experiments at higher fluorination temperatures, and experiments to test the behavior of gamma-ray emitting fission products.

I replied to Stoughton, informing him that his fluorinated samples are now on the way back and giving him suggestions on the procedures to follow in measuring them. I asked that he order another fifty pounds of thorium nitrate in view of the slow delivery. Also informed him that I am distressed about the interruption in the bombardment of his thorium sample.

I have now reached Lecture VII of my evening course, "An Introduction to Nuclear Chemistry," Tonight I gave a brief summary of range-energy relations of alpha particles and beta particles and the meaning of absorption coefficients. This included a demonstration, put on with the help of

6/30/42

English and Covey, of the operation of the necessary equipment. The meeting was held in a room in Ryerson Laboratory because our regular meeting place, 316 Eckhart Hall, is not equipped to allow such a demonstration. I then followed with an explanation of decay curves, i.e., simple decay, growth curves and the decay of chains. After the lecture a number of us joined our wives at the Fermis' for refreshments.

JULY 1942

Wednesday, July 1, 1942

Two more excellent Research Associates were added to my staff this morning. One is Burris Cunningham; I interviewed him in Berkeley early last month and then immediately offered him a position to work here in ultramicrochemistry. He will work in Room 405, which we are setting up as our laboratory for ultramicrochemistry. The other is Arthur H. Jaffey, whom I interviewed here about three weeks ago and also immediately offered a position. I shall have him work on extraction processes for 94, using space at the remaining laboratory bench no. 5 in Room 404. Their salaries have been set at \$300 per month. Two Laboratory Helpers have also started with us—Wallace H. Vogwill and George Bowers; Covey will supervise their duties initially until they obtain enough experience to be more generally useful to the members of my group.

I wrote a letter to Libby at Columbia and enclosed an abstract of my paper, "Review of Artificial Radioactive Isotopes Useful as Tracers," to be presented at the American Chemical Society meeting in Buffalo this September. I mentioned that Mrs. Seaborg is the former Helen Griggs and expressed the hope that we could get together with Mrs. Libby and him in New York, Chicago or perhaps at the Buffalo meeting.

Headlines in the paper today are depressing. A major push by the Axis perils Egypt; they are heading for Alexandria. The Nazis have passed El Dabn, which is one hundred miles from Alexandria.

Thursday, July 2, 1942

Today brought letters from both Latimer and Garner. Latimer is scheduled to arrive in Chicago tomorrow and hopes to see me in the afternoon.

7/2/42

He said that he has persuaded Wahl, who has confined his efforts to his own problems, to take charge of the group working on 94^{239} and believes that that part of the program will be strengthened considerably.

Garner said that he and Bonner expect to complete their search for 94 in the carnotite, fergusonite and hatchettolite ores within a week or so. He asked about the possibility of simplifying the ore treatment by using a pre-formed lanthanum fluoride precipitate based on the work of Spof English. He and Bonner are delighted at the prospect of working on the oxidation potential of 94 as I suggested. He said, personally, he is very anxious to undertake some chemical studies of 94, and oxidation potentials have always interested him. He also talked about a replacement later on for Bonner, who is going to Princeton for graduate work in September.

The Engineering Council met, attended by Allison, Compton, Doan, Fermi, Hilberry, Leverett, Moore, Spedding, Szilard, Wheeler, Whitaker, Wilson, Wollan and myself. The subject today was the experimental plant. Compton listed eight studies that have to be made, among them getting a chain reaction and producing gram quantities of 94 for chemical tests. Compton wants the first pile in the West Stands, and Fermi, along with Whitaker and Zinn, believe that there will be hardly enough room in the handball court because the cube will be 23 feet on a side. Compton said two piles are proposed, pile I of less than 100 kw and pile II of less than 5,000 kw. There ensued a discussion as to which of the eight studies might be investigated with pile I, which with pile II.

According to calculation, 1,000 kw will produce one gram of 94 per day. I mentioned that we are currently getting 30 micrograms per 300 pounds of material at St. Louis and that anything above this would be a definite gain, especially gram quantities. Compton said our goal is 6 kilograms of 94, and there was talk about using pile I to give small amounts of 94 to the chemists, whereas Pile II might become the pilot plant, in which case it should be capable of operating above 5,000 kw. It was recognized, however, that there are some advantages to having pile II serve as the pilot plant. The materials for construction of

7/2/42

pile I should be available by October 15, 1942, and for pile II by December 1, 1942. Pile II will require somewhat sophisticated provisions for cooling; and, if helium is used for cooling, as decided tentatively at last Thursday's meeting of the Engineering Council, orders for heat exchangers and blowers should be placed as soon as possible. Later, Compton mentioned that the separation process amounts to a considerable part of the whole project and that we are not yet able to calculate when we can get out of the 94. I observed that the extraction problem is less of a chemical problem than one of operating a chemical extraction process in the presence of high levels of radiation, which places unusual constraints on the procedure.

The Research Associates meeting was held this evening from 7:45-9:15 in Room 251 of Ryerson Laboratory, and I attended as usual. Compton, Allison and Moore gave us a good overview of the status of the Project in recognition of the start of the new fiscal year yesterday.

The news today has a double worry. There is worry for the French fleet, which is at Alexandria. The British are making a stand west of Alexandria but plan to move or destroy the French ships. At the same time, Berlin claims to have taken Sevastopol. The Russians say this Crimean port has withstood as many as twenty assaults but has not fallen.

Friday, July 3, 1942

I had a discussion with Magel and Koshland about their progress on developing a solvent partition method for separating 94 from uranium and fission products. Their aim is to find an organic solvent that extracts 94 from the aqueous phase when it is present in one oxidation state but does not extract it when it is present in the other oxidation state. Presumably the oxidation procedure would not effect the solubility of the uranium and fission products in the organic solvent so alternate extractions with the 94 in each of its oxidation states should effect the separation. Their early experiments show that little 94, in either oxidation state, goes into the organic solvent (ethyl ether, carbon tetrachloride, ethyl

7/3/42

acetate, chloroform, ethylene dichloride, methyl ethyl ketone containing 10% xylene) when the partition is between the organic solvent and pure water. They find, however, that under certain conditions the 94 can be "salted out" into the organic phase. Methyl ethyl ketone containing 10% xylene, with lithium nitrate as salting agent, is very effective for oxidized 94 and quite effective for reduced 94.

Latimer has arrived in Chicago and visited me in the afternoon to discuss the work of the Berkeley group. He and his family are in town for a few weeks in connection with his work at Northwestern University.

Melvin Calvin also arrived this afternoon, which gave Helen and me the opportunity to spend some time with him.

News from Africa today is mixed; Rommel attacked the British at El Alamein, but at the same time the British sent a force against Rommel's rear flank.

Saturday, July 4, 1942

I made the rounds of the laboratory benches in Room 404 to learn the status of the various investigations.

Perlman and Knox find, using short-lived fission activity produced by neutron bombardment of uranium using the Chicago cyclotron and 50-year 94 as tracer, that a considerable fraction of the fission products, some 20-30%, comes down with a single precipitation of uranium peroxide. There are, however, indications that most of this can be eliminated by reprecipitating the uranium peroxide. In two experiments about 85% of the added 50-year 94 survived this process. They showed that, of the 20-30% fission products in the first uranium peroxide precipitate, about half precipitates with lanthanum-cerium fluoride, indicating that much of this activity belongs to rare earth fission products.

Brown and Hill fluorinated the deuteron-bombarded molybdenum target

7/4/42

on Tuesday and have spent the intervening time determining the behavior of the fluorinated products. In the part of the sample that was fluorinated at 250°C only 7% of the molybdenum remained behind while about 43% of the 43 remained behind. In the part that we fluorinated at 450°C about 12% of the molybdenum remained behind and also only 12% of the 43 remained behind. The conclusion seems to be that the higher fluoride of element 43 is volatile, but not as volatile as molybdenum fluoride.

It is interesting that in times such as these the headline reads "Extra two-pound sugar ration!" The regular allowance is two pounds every four weeks.

Sunday, July 5, 1942

Today we took our regular Sunday holiday. Helen and I, along with the Perlmans, Browns and Burtons, drove out on State Highway 4A to explore the proposed Argonne Forest Preserve site at Palos Park where it is rumored the experimental chain reacting pile will be built. Compton and his wife discovered it one Saturday afternoon while horseback riding. He said it is an isolated area about five miles northeast of the village of Lemont and twenty miles west of the University of Chicago campus. We had a fine lunch in the general area there but are not sure we found the actual site.

Monday, July 6, 1942

Willard's student, Elton H. Turk, started work here today as a Research Assistant. He will work with Willard, at his bench in Room 404, on the adsorption method of separating 94 from uranium and fission products.

Last month I phoned Emilio Segrè in Berkeley for some data on xenon beta and gamma ray absorption that he, in collaboration with his co-worker, Chien-Shiung Wu, determined about three years ago. Today I received a letter from Segrè with all the information that I requested. He

7/6/42

included assignments of various xenon isotopes to their half-lives.

Wahl wrote from Berkeley, telling me that next week he will send the 50-100 grams of neutron-bombarded UNH requested in my June 26 letter. He said that he was surprised, on reading my June 20 weekly summary, that plutonium cannot be extracted from the fluorinated residue by persulfate ion and silver ion, and he offered some suggestions.

I received a letter from B. J. Fontana in Berkeley, describing the work done to demonstrate the absence of polonium, protactinium, radium and ionium from the final electroplates of U^{234} derived from UX_1 , which were given to Gofman. The electroplates contained, respectively, 0.36 and 0.29 microgram of U^{234} , using the values of 12,000 U^{234} alpha particles per minute per microgram.

Joyous news from Kamen at the 60-inch cyclotron. I will quote his letter in its entirety. "I have enjoyed your letters very much," he said, "and it seems a shame that I cannot equal in this letter the wry humor of certain sections. The outfit is going back together today (July 2) or tomorrow and now I hope that it will be producing a useful beam in about a week. I feel certain that in two weeks we can run through your bombardment. There is no other news than this and we will keep you informed of our progress. Regards to Helen."

The papers say that our Air Force bombed the Germans yesterday for the first time. It was a daylight raid over Holland in cooperation with the British RAF and is part of a strategy to relieve German pressure on the Russians and bring Germany to her knees. Also, it has been reported that the British raid over Cologne last month killed 20,000 and wounded 54,000 more. I think that, were we forced to use our 94 bomb, the devastation would be unthinkable.

Tuesday, July 7, 1942

Judging from the size of my weekly reports on "Group I: Chemistry of

7/7/42

94," the pace here is accelerating. My report just one month ago was three pages long, and today's report (CC-169) for the week ending July 3 is ten pages long. I can report on experiments now by Perlman, Brown, Magel, Willard and English and their assistants. Included is Perlman's investigation of the extent to which small amounts of short-lived fission products (produced by irradiation of uranium with neutrons from the Chicago cyclotron) come down when relatively large amounts of uranium are precipitated in their presence with hydrogen peroxide—between 20% and 30% with a single precipitation, with indications that most of this can be eliminated by reprecipitating the uranium peroxide.

Brown's investigation using radioactive element 43 (atomic no. 43, produced in Berkeley by bombarding a molybdenum target with deuterons) is reported, indicating that it forms a volatile fluoride at about 450°C. The non-volatility of 94 fluoride was tested by using volatile selenium, tellurium and antimony fluorides as possible carriers. In all cases the 94 remained behind quantitatively.

Brown also has investigated the solubility of the carbonate of element 94. He reports that only one percent of the activity comes down with a lanthanum carbonate precipitate, thus indicating that 94 carbonate is soluble. Of the fission products that are left behind after fluorination of uranium, all except rubidium and cesium form insoluble carbonates. Brown concludes that the use of a carbonate precipitation after the fluorination process might thus eliminate the necessity of carrying out an oxidation reaction in order to separate 94 from the fluorination residue.

It might be possible to develop a method for separating 94 from uranium and fission products by using the method of distribution between two liquid solvents (such as water and an organic solvent), in particular by taking advantage of the two oxidation states of 94. R. B. Duffield has been carrying out experiments of this kind in Berkeley. The results of preliminary investigations now being conducted here by Magel are reported. His first experiments show that the addition of salts enhances the transfer of 94 to the organic phase.

From the standpoint of radiation protection, it is highly desirable to look for a shorter way to separate 94 from the uranyl nitrate that is being bombarded in St. Louis. It is possible that an adsorption method might be better suited for this purpose. Likewise adsorption methods

7/7/42

should be investigated as a possible means of separating 94 from the uranium and fission products formed in large-scale chain reactors. With this in mind, Willard has begun experiments with various adsorbents and reports preliminary results indicating that silica gel and aluminum oxide show promise.

English reports the results of his experiments to test whether or not 94 forms a volatile tetraoxide (by analogy with ruthenium and osmium); such a property could form the basis for a volatilization process for separating 94. He finds that 94 in its upper and lower oxidation states is non-volatile under the conditions in which ruthenium and osmium tetraoxides are volatile.

In the evening I presented Lecture VIII of my evening course. Topics covered were the use of the characteristics of x-ray absorption to identify atomic numbers of elements formed in nuclear reactions, and various techniques for separation of radioactive products (carriers, electroplating, volatility processes, solvent extraction, adsorption, leaching, Szilard-Chalmers method). After the lecture a number of us followed John P. Howe, a fellow Research Associate, to his home (6105 Kimbark Avenue) for refreshments. Our wives were already there chatting with his wife Marilyn. Howe received his Ph.D. in physical chemistry from Brown University in 1936, was an Instructor at Ohio State University 1936-1938, and an Assistant Professor 1938-1942. He is working on radiation problems in Burton's group.

Wednesday, July 8, 1942

I spent some time in Room 404 and in the counting room (Room 402) talking over experiments with the fellows in my group. Perlman is working on a 5-gram sample of UNH that he ether-extracted on June 26 and then sent to the Chicago cyclotron. It was given 160 microampere-hours neutron bombardment (from beryllium plus deuteron reaction), mostly on July 4 and yesterday; so he will have some fission products with medium half-lives with which to work. He saved another 5-gram ether-extracted sample of UNH in order to measure the UX_1 - UX_2 background. The usefulness of the hydrogen

7/7/42

peroxide method for separating 94 depends on whether or not appreciable amounts of fission products come down with the uranium peroxide.

English is working on another experiment to determine whether or not the oxide of 94 is volatile at high temperature. When I saw him, he was centrifuging a sample of 50-year 94 (380 alpha counts/minute) and 0.3 mg of La^{+3} in 6 N HF. After washing in 6 N HF and then with HNO_3 , he will dry the residue and heat to redness over a Fisher burner for five minutes. The count will give him a measure of the volatilization. He tried the experiment yesterday and his yield of 84% in the residue shows that the volatilization is almost insignificant. Monday he investigated the dry distillation of 94 chloride in air at high temperature. A quantitative recovery of 94 from the residue with lanthanum fluoride carrier indicated that no 94 was volatilized there either.

Hill spent most of the day yesterday and today in the counting room measuring the radioactivity of fluorinated samples supplied him by Brown. Brown started with a gram of UF_4 that was subjected to neutron irradiation from 150 microampere-hours of deuterons on beryllium with the Chicago cyclotron. The bombardment was stopped at three Monday afternoon. I saw the sample when it came back. It was imbedded in a paraffin block, the sample itself having been placed about two inches from the beryllium target. The fluorinations took place at 450°C and the volatile products were collected in a trap maintained at -78°C . It will be a day or so longer before the analysis is complete.

Joyce Stearns called to suggest that I call off my Tuesday night nuclear chemistry lectures after next week. He feels that the social gatherings, including beer drinking, that follow the lectures have become too time-consuming and disruptive from the standpoint of achieving maximum progress on the Laboratory's mission. Fortunately I will have covered all the material I had planned.

Wednesday night is family night for swimming in the pool at Ida Noyes Gymnasium, and tonight Helen and I took advantage of this opportunity.

Thursday, July 9, 1942

Yesterday Helen received a letter from her friend Wilma Ghiorso, top Radiation Laboratory secretary, inquiring whether I would be willing to recommend her husband, Albert, for a spot in the U.S. Navy doing radar work. It occurred to me last night that Albert, who is still producing Geiger counters for Cyclotron Specialties Company in Moraga, California, may be persuaded to come to Chicago. Ghiorso has a degree from the University of California in electrical engineering. So I wrote to him today, saying that I am very much in need of a man with his training to help keep all of our Geiger counters and linear amplifiers running and to do development work in this field. "You would be by far the best man for the job," I added. "The work would be done pretty much in collaboration with Mr. English." I urged him to come as quickly as possible if he accepts the official offer that will come from Stearns.

The Engineering Council met again with Allison, Fermi, Leverett, Moore, Spedding, Stearns, Szilard, Wheeler, Wigner, Wilson, Wollan and myself in attendance. The major topics of discussion were the need for heat transfer data in designing the 100,000 kw plant, and possible designs and tests for control rods. Wigner said experiments are in progress to investigate water as a coolant alternative to helium gas. Fermi was afraid a control rod might get jammed in a shifting pile until Wilson suggested using a duct in the pile to admit the rod. Szilard and Wheeler thought that it might be necessary to have at least five rods. Although the chain reaction could be stopped with one control rod, it might start up again as the pile cooled down. On the subject of packing and lubricants, I suggested that carbon fluorides might be superior to oil from the standpoint of radiation damage.

Because Friedlander is an alien, he cannot be put on the payroll of the Berkeley project. To support himself he is teaching two sections of Chemistry 1A in the Berkeley Summer Session. I received a letter from him saying that he has no time left over to do much research at present.

7/9/42

Latimer gave instructions to Wahl not to show Friedlander my weekly reports from Chicago any more, which of course greatly perturbs Friedlander. He feels torn because he was given secret information in the past but does not have official clearance. He went to the Immigration Department the other day and had an interview with an inspector from the FBI. The inspector said he had very excellent reports on his character and ability but one adverse report saying Friedlander at one time had been connected with a group having Communist leanings and that he would have to be investigated further. He was deeply shocked because he has never belonged to any political group or organization that would fit this description, which he had declared under oath to the Immigration Department. He remembered he occupied a house last year where it was rumored some Communists lived, but the agent would not commit himself to any specific charge. Friedlander was chagrined at not being able to learn how long it might take to get his naturalization papers. So now he is in a quandary about how to straighten things out. He wondered if I would talk the situation over with Latimer when he comes to Chicago.

Friedlander also wrote that Gofman has now solved the problem of mounting samples of 94 that are practically infinitely thin, a method that can be easily adapted to other elements. He went on to say, "As for a magnesium (U^{235}) sample, Kennedy tells me that he has a good sample for our purpose, and that he is willing to loan it to us for some time, but that he is not free to tell me the analysis, as long as I am not cleared. I can, of course, not plan measurements intelligently if I do not know what the samples are."

Blanchard, according to the above letter, is now working full time on the Berkeley project and is very useful. He just finished making a pulse generator and is putting together a high resolving-power amplifier.

I received a letter from Gofman saying he and Duffield are ready to start the fast neutron fission measurements as soon as the one-gram Ra-Be arrives; he has worked up the deuteron-bombarded thorium and is now following the decay of the samples. He reports that there is no hope of producing U^{233} by this method as the yield is too low. Also there appears

7/9/42

to be a short-lived Pa^{232} decaying by beta emission into an alpha-emitting U^{232} of reasonably short half-life, which he will verify in about a week. He reassures me that the electroplated samples of U^{234} that Fontana gave him are truly U^{234} . He has completed a long spontaneous fission count on the 0.4-microgram sample and stands ready to write a report on this and on the new Pa^{232} - U^{232} isotopes.

My response to Gofman was three pages long. I praised him and Fontana on the chemical identification and alpha range measurements of U^{234} they have been making. I asked if he would write one report of their work on the spontaneous fission of U^{234} and another on the slow neutron fission of U^{232} . I told him that I am excited by his news of the thorium work and, if he has really found a relatively short-lived U^{232} , it will be very useful to the work here, in which case we should think about a long-term deuteron bombardment of thorium. I promised to get some metallic thorium sent to him. I added that if he will determine the ratio of (d,n) to (d,2n) yield for thorium, it will help us make an isotopic assignment for the 50-year 94. I suggested he also write this up as a final report and send it to me.

To quote in part from my letter, "I have learned, in a letter from Friedlander and in conversation with Latimer, that there have been some discussions with Professor Oppenheimer with regard to your fast neutron work, and that you and Friedlander might be a little confused as to what to do. I believe that you should go ahead on essentially the basis that we discussed while I was in Berkeley; that is, measure the relative cross sections of U^{233} , U^{235} , U^{238} , 94^{239} and Pa^{231} . During these experiments keep in mind the possibility of making an absolute cross section measurement, for example on U^{238} as presumably Professor Oppenheimer has suggested, or on U^{235} , and perhaps make a few experiments along that line. However, this I think to be quite difficult, and the progress of this phase of it should not interfere with the relative cross section measurements....

"You and Duffield will have to do this fast neutron work without a great deal of help from Friedlander. I am doing my best to obtain permission for Friedlander to work officially on the project so that he can receive pay for his work and not have to spend his time teaching, which takes up

7/9/42

practically all of his time. Will you get the new U^{235} sample from Kennedy? Kennedy doesn't feel he should tell Friedlander its composition. I am writing Friedlander so he will receive a letter at the same time you do.... I certainly am sorry that he is having so much trouble over his citizenship.

"There is some possibility that Breslow will leave the Berkeley project. We will need some uranium tracer here in Chicago, and unless your U^{232} fills the bill completely, we will continue to require to have some seven-day U^{237} sent us.... Will you ask Duffield if he will discuss this with Breslow, and learn enough about it to take it over? I think that he and Hamaker could probably handle it very well....

"Here is something very important! The FBI is tightening down very much on the information in regard to 94, and therefore I want to warn you to be extremely careful in your treatment and discussion of such data. Please pass this information on to Wahl, Duffield, Garner, Hamaker, Bonner and Friedlander. I am sure that you are all being careful, but bear in mind that checks are being made by the FBI in order to be sure that every one of you is careful."

This evening I went to Room 251 of Ryerson Laboratory to attend the Research Associates meeting. Teller, Leverett and Szilard were responsible for this program, and next week it will be up to A. C. G. Mitchell and me. This meeting takes place each Thursday throughout the summer, the purpose being to provide general information regarding the work done by the groups and to become better acquainted with the other Research Associates on this project. After the meeting, Teller told me privately that he is on his way to Berkeley where he will stay for a month. I asked him to discuss the Berkeley program on 94 with Wahl and the program on U^{233} and U^{234} with Gofman.

Friday, July 10, 1942

English informed me of an experiment that he and James completed yesterday. In a previous experiment, they used bromate with a cerium catalyst in an attempt to form a volatile oxide of 94, but the results

7/10/42

were negative--no 94 activity appeared in the distillate. There is a chance, however, that a powerful oxidizing agent, such as ozone, might oxidize 94 to its +8 state; this oxide might possibly be volatile. In yesterday's experiment, a 3-5% mixture of ozone was bubbled through a nitric acid solution containing 50-year 94 tracer, 1.5 mg of Ce^{+4} and 12 mg osmium carrier. Their analysis of the distillate failed to show the presence of 94, whereas 88% of the 94 tracer was recovered in the unvolatilized residue. Of the 94 recovered here, 93% was in the upper (fluoride soluble) oxidation state, and only 7% was in the lower (fluoride insoluble) state. Today they tested the volatility of 94 bromide using selenium bromide as volatile carrier and find that the 94 bromide is not volatile.

Louis B. Werner, whom Cunningham has recommended to me, started work as a Research Assistant this morning. He comes from Berkeley where he was a graduate student in biochemistry and had a part-time job assisting Cunningham and Paul Kirk. I always thought I was tall, but Werner is 6'7", taller by four inches! I am assigning him to work with Cunningham along with Cefola in Room 405, a tight fit in this small room.

I wrote to Garner in response to his June 29 letter and suggested that he consult Latimer about getting a graduate student to help on the search for 94 in uranium ores, thus freeing himself somewhat to investigate the oxidation potentials of 94. Some time ago 25 pounds of pitchblende were ordered from Port Hope for the purpose of confirming the presence of 94^{239} in pitchblende. I asked him to see if it has arrived and what he thinks about the experiment, as it would entail a great amount of work. With regard to his request for information on English's experiments, I sent details of the procedure for carrying 94 with a preformed lanthanum fluoride precipitate.

Next I wrote to Fontana and congratulated him on the chemical isolation of the U^{234} samples, which involved such a difficult procedure. I said that since he has perfected a good method of removing U^{234} from electroplates, he has the basis for combining a number of small samples into a large one, and that he will be able to give Gofman, for his fission measurements, some larger samples as the present decaying UX_1 samples come along.

7/10/42

My last letter of the day was dictated to Wahl in Berkeley. I expressed my pleasure at hearing from Latimer that he has joined Latimer's group and said that the move will be mutually beneficial. I told him about Teller's upcoming conferences with him and Gofman. "Teller," I said, "in the spirit of a true theorist will probably be anxious to do some theoretical calculations in connection with your work. I can't see that there is anything useful that he or anybody else can calculate—it is impossible to devise the chemical procedures we need by calculations—and so I wouldn't worry about trying to provide him with any ideas for such calculations; merely tell him about the work you are doing, and ask Gofman to do the same, so that Dr. Teller can become familiar with your program.

"Apparently your large sample of 94^{239} will be forthcoming some time before our St. Louis sample is ready. Will you let me know how you handle your extraction problem? Likewise, we should like to have a fraction of your 94^{239} for the microchemists here, even before you start the long spontaneous counting experiments. We are anxious to try out some of the precipitation reactions with pure stuff, and especially the peroxide precipitation because this seems to offer the best hope for a separation procedure at the present time." I asked if he could spare about 15% of the large sample, and then cautioned him, as I have Gofman, about the FBI tightening on secrecy measures.

Newspapers indicate that the Germans continue to gain in Russia and are within 235 miles of the Volga River.

Saturday, July 11, 1942

Upon checking with Magel and Koshland, I find they have made more progress in their efforts to find an organic solvent-water partition method for separating 94 from uranium and fission products. They have measured the distribution of 94, using 50-year 94 as tracer, between water and each of a number of additional solvents. The 94 was present in its lower oxidation state in some experiments and in its higher oxidation state in some other experiments, and lithium nitrate was used as the

7/11/42

salting agent in all the experiments. They tested ethyl bromide, nitromethane, nitroethane, 1-nitropropane and 2-nitropropane and find that nitromethane exhibits the greatest difference in its behavior toward 94 in its two oxidation states.

Latimer paid us a visit today. He and his family are staying near Northwestern University.

Sunday, July 12, 1942

It was humid and hot today and a relief to get out of the apartment. Our Sunday outing was to attend a gala picnic at Jackson Park near the campus and the beach. It was organized strictly for California people working on the projects here at the Met Lab and Northwestern University, and I guess there were at least forty of us. Latimer and his family came also and spent part of their afternoon with Helen and me. He said that he finally has received the letter of intention, which makes him very happy. There is no longer any doubt that the Berkeley project will go ahead with full momentum. Most of us have been so busy with the war effort that we don't get much of a chance to see each other in a social way; so today was a double pleasure.

Monday, July 13, 1943

For the last week Turk has been helping Willard with his experiments on various adsorbents. Some of the adsorbents being tested are aluminum oxides, powdered silica gel, various resins, Fuller's earth, BaSO_3 , BaSO_4 , Amberlite and Hyflo Super Cel. In these experiments, 10 cc of a uranyl nitrate solution—10% $\text{UO}_2(\text{NO}_3)_2 \cdot 6\text{H}_2\text{O}$ by weight containing 50-year 94 tracer—to which a weighed amount of adsorbent is added, is stirred a few minutes and then centrifuged. The supernatant liquid is divided into two portions, of which one is analyzed for uranium and the other analyzed for its content of 94. Of all the adsorbents, including those tested today, the Hyflo Super Cel is best; this is a commercial filter aide made by

7/11/42

Johns-Manville Company, which is 93% SiO_2 . The Hyflo Super Cel adsorbs over 85% of the 94 and yet removes only 5% of the uranium. Willard plans to investigate this unusual material further. Today he and Turk are setting up Tswett adsorbent columns for comparative experiments with Hyflo Super Cel and some other adsorbents.

I learned of a decision to build a new chemistry building for the chemists on the Project; the responsibility for this will be given to Stone and Webster Engineering Corporation. The groups with Spedding, i.e., Boyd, Coryell, Burton, will have one wing, and I will have the other; there will be sufficient space for our present and future needs. The target date for completion is about three months, and it will come none too soon. The contract for construction and laboratory equipment amounts to about \$200,000. Milton Burton will play a major role in summarizing the space needs of the various groups and translating these into a floor plan.

My date to speak at the American Chemical Society in Urbana has now been set, more or less. H. A. Laitinen, who is Secretary of the University of Illinois Section, wrote that October is entirely satisfactory. He will let me know the exact day by the end of August.

First I sent a telegram to Gofman in Berkeley and then I followed it up with a letter. The Western Union message asked him if he has received the one-gram radium-beryllium neutron source, which the manufacturer should have shipped a week or so ago. For fast neutron fission measurements using this source I suggested he use his 4-microgram U^{233} sample, Kennedy's 3.5-microgram 94^{239} sample, a larger enriched U^{235} sample from Kennedy, a larger Pa^{231} sample from Stoughton and a sample of natural uranium as a source of U^{238} . My letter informed him of the solid stick of thorium he is about to receive from me by mail, which can be used for making targets for deuteron bombardments. I warned him that thorium is extremely pyrophoric, especially in the powdered form. The bulk of my letter, however, concerned a talk that John Manley and I have had concerning the program here for measuring the fast neutron fission cross sections of a number of heavy isotopes. Manley here is charged with the responsibility, together with

7/13/42

Oppenheimer at Berkeley, of seeing that the fast neutron fission cross sections are measured. I noted that he is enthusiastic about the similar experiments that Gofman and Duffield, with some help from Friedlander, are undertaking using Ra-Be neutrons; he is writing Oppenheimer about the possibility of making similar measurements using Kennedy's photo-neutron sources. I said that Manley and I also laid out an additional detailed cooperative program for the measurements of the fast neutron fission cross sections with various sources of monoenergetic neutrons, such as those from D+D and Li+p, using an additional independent set of samples of ^{94}Zr , U^{235} , U^{233} and natural uranium of uniform thickness; a 5-microgram sample of ^{94}Zr might come from the present Berkeley or St. Louis bombardment, Kennedy might furnish the enriched U^{235} , a 5-microgram sample of U^{233} might come from Stoughton's present neutron bombardment of thorium, and the natural uranium sample could be prepared either at Chicago or Berkeley; these samples should be ready by October.

Depressing is the news again as the Germans cross the Don River in the Soviet Union and Rommel drives ten miles west of El Alamein.

Tuesday, July 14, 1942

One of the most important problems related to the isolation of 94 by the fluorine method is the determination of the percentage of fission products that will be carried over with the UF_6 and away from the non-volatile 94 fluoride during the fluorination process. Brown's earlier experiments, using fission products of rather short half-lives (about four hours after bombardment), show that, if the fluorination takes place at about 250°C , roughly half of the fission activity will be carried over with the uranium. In today's "Report for the Week Ending July 11, 1942, Group I: Chemistry of 94" (No. CC-179), I say that further studies now show that the carryover of long-lived fission products is the same under the same conditions. Furthermore, according to experiments last week, if the fluorination process takes place at 450°C , 80% of the fission activity, when fluorination takes place 48 to 96 hours after neutron bombardment, passes over with the volatile UF_6 .

7/14/42

In the weekly report I also say that Magel and Koshland have investigated several possible organic solvents, including several nitroparaffins, for a solvent method of separating 94. Nitromethane, it is concluded, seems to offer the most hope in that it exhibits the greatest difference in its behavior toward 94 in its two oxidation states when lithium nitrate is used as a salting agent. The theory underlying the solvent partition method is this: the separation of 94 from the uranium and fission products might come about by taking advantage of the distribution of the two oxidation states of 94 between two solvents (water and an organic solvent). One would search for a solvent that would not extract 94 from the aqueous phase when it is present in one oxidation state but would extract it in the other. If found, then one extraction could be made to remove from the aqueous phase those substances that are soluble in the solvent, leaving behind the 94 and other insoluble materials. Then the oxidation state of the 94 could be changed and another extraction carried out to put only the 94 in the solvent. Presumably, the oxidation procedure would not affect the solubility of the other substances.

I also report on English's results showing the nonvolatility of 94 oxide and chloride.

Perlman and his helper Knox are continuing their experiments to determine fission activity in uranium peroxide precipitates. They are still using samples of the neutron-bombarded UNH of a week ago because they want to investigate the longer-lived fission products. A peroxide precipitation was made from two samples today and the precipitates will be counted tomorrow. A similar experiment yesterday showed that only 15% of the total fission activity came down with the uranium peroxide, whereas their earlier experiments with short-lived fission products resulted in 25-30% of the fission activity precipitating with the uranium peroxide. In several experiments, 85-95% of the co-precipitated fission activity was found to be fluoride insoluble. Reprecipitation of the rare earth fluoride retained all of the activity. The fact that fluoride insoluble substances come down with 94 in a uranium peroxide precipitate places more burden on any subsequent oxidation-reduction cycle using rare earth fluoride as carrier.

Ghiorso sent a postal telegram saying that he appreciates the offer

7/14/42

of a job but wants assurance that developmental or research electronics will be involved. He said the U.S. Navy offer is substantially more lucrative but he prefers an academic environment. I wired back that development and research electronics are definitely involved and assured him that the work is very interesting and extremely important and has a good future.

We were pleasantly surprised to have a visit this afternoon from Carlos, our good friend and confidant, the janitor for Gilman Hall on the Berkeley campus--he is on a vacation trip in the Midwest and decided to pay us a visit.

Tonight I gave my concluding lecture, the ninth, in my series on "An Introduction to Nuclear Chemistry." The topics covered were the chemical method for separating nuclear isomers, the Hahn precipitation rules and the quantitative treatment of isomorphic replacement. As customary, some of us gathered with our wives afterwards for a social get-together; this time it was at the Burtons'.

More bad news from the Russian front! The Reds have retreated after a twelve-day battle with their Don River lines ripped.

The Technical Council met with Allison, Compton, Fermi, Moore, Szilard, Wheeler and Wigner attending. Fermi announced that the most recent experiments on U^{235} give a value of 1.29 for η , the average number of neutrons emitted in fission per neutron captured. But the news that evoked the most discussion was his statement that beryllium gives an improvement in k , the multiplication factor, so that if the pile were covered on six sides with beryllium there would be a gain of two percent. Szilard commented that this amount of gain might make it possible to use the oxide of uranium. Enthusiasm was dampened somewhat when Compton declared that the supply problem for beryllium is comparable with that for uranium--that 1,000 pounds of beryllium would exhaust the nation's supply for one year--and now there is talk of using an aluminum alloy of beryllium for aeroplane engine production. He wondered what the size of a pile might be using beryllium

7/14/42

for the moderator, and Fermi replied that an all-beryllium structure offers no advantage.

Fermi indicated that the planned 1,000 kw pilot plant to be built at the Argonne site in Palos Park might use 4 tons of uranium metal (for which $k = 1.09$) surrounded by uranium oxide ($k = 1.03$), together with about 300 tons of graphite (about 800 tons if only oxide is used). An estimate was made by Fermi that a 1,000 kw plant will produce 30 grams of 94 in 30 days and that a huge amount of radioactivity will be produced, of military importance at least in an experimental way. He also suggested a pilot plant be built at the site for chemical separation of the products. He was very concerned about shielding the experimental plant, saying that at 1,000 kw it will give 50 roentgens per minute at the surface, which is a lethal dose after ten minutes. It was suggested that Moore, who is already engaged in planning the chemical extraction plant for the production plant, ask his chemical engineer to help with plans for a pilot chemical plant at the Argonne Forest site of the experimental pile. Moore said he has picked the best four chemical engineers from a list of 20 from the du Pont Company and hopes to get one of these. This was followed by a discussion of how to combat the radiation problem in the pilot and production chemical plants. Szilard asked if Fajans at Ann Arbor could not help Coryell to work out a complete picture of fission products in order to speed up progress.

Allison informed the group that Stone and Webster Engineering Corporation is working on a building to house the members of the Chemistry Division.

The group then talked about the necessity of dropping a good part of the study of general nuclear physics so that the problems involved with the construction of the experimental pile could be solved-- otherwise an additional hundred men, who are unavailable and for whom space is not available, would be needed. No decision was made about the geometry of the experimental pile; that is, will the uranium oxide be removed from vertical or horizontal columns? Of course this affects the size and shape of the room at the Argonne pilot plant,

7/14/42

and a decision must be made by November 1 at the latest. Szilard continued to advocate liquid bismuth as the cooling agent for the pile.

The Planning Board also met. It was attended by the same group except that Hilberry, Spedding and Whitaker were added and Moore dropped out. The subject under consideration was the shell that will surround the 1,000 kw experimental pile at the Argonne Forest Preserve site. Compton opened the meeting by saying what to do is the question, but how to do it will be up to Whitaker. The proposed shell will be a rigid, self-supporting tank, 30 feet in diameter and 30 feet high. Whitaker said that he has drawn up plans, which turned out to be like those of Moore's. Their idea was to have trap doors to release selected columns of uranium for extraction of 94 for chemical experimentation, through which the whole pile could be dumped later. There would be a funnel over each hole for reloading. Fermi and Wigner favored horizontal channels. Wigner outlined a scheme proposed by him and Edward C. Creutz. There would be "pushers," with arrangements for reloading. Fermi added that part of the tank could be cut away and a concrete wall of about two meters be erected for shielding; then one could push from behind the wall with impunity. Compton pointed out that there will probably be the first pile (1 watt) as well as the 1,000 kw pilot plant pile at the site.

The next subject to be discussed was the design of the chemical extraction plant. Compton suggested that Ruhoff be brought from St. Louis this week to help design the plant. He said that there is not much difference whether we get out ten grams or a hundred grams of 94 from the point of view of experiments on the product and knowledge of radiation problems.

Wednesday, July 15, 1942

Several properties of 94 in its lower oxidation state indicate a close similarity with the rare earth elements. For example, in the earliest and much used isolation procedure, the fluoride of reduced 94

7/15/42

co-precipitates with lanthanum fluoride in acid solution. In order to find an alternate precipitation method for removing 94 that does not involve the use of the corrosive HF, the possibility of other precipitants, more or less unique to the rare earths, can be considered.

Jaffey is investigating the precipitation of 94 with rare earth iodates. In neutral solution, the iodates of the +3 rare-earth elements are fairly insoluble, and that of the +4 rare earth (Ce^{+4}) even more so. Very few cations form iodates that are insoluble to this extent. Today he precipitated lanthanum as an iodate in the presence of tracer 94. The 94 alpha particle activity of the precipitate was measured directly, and as a check, an HF precipitation of lanthanum fluoride from the filtrate was made and counted after adding more lanthanum carrier. It was found that the 94 does not come down quantitatively with the lanthanum iodate.

Another experiment was conducted today by English and James as a follow-up to their attempted distillation of 94 as oxide from an ozone-cerium solution. In this case, argentic ion was substituted for ceric ion as a catalyst in the ozone oxidation. The theory is this: it is already known that cerium functions as a catalyst for the oxidation of 94 from its lower (fluoride insoluble) state to a higher (fluoride soluble) state. If cerium were also involved in the hypothesized further oxidation of 94 to its +8 state, then the oxidizing potential of ozone is effectively reduced to that of the cerous-ceric catalyst. An argentous-argentic couple, however, has an oxidation potential that is only slightly less than that of ozone itself. It is thus more likely that 94 can be oxidized to its +8 state. In today's experiment, ozone was passed through a solution containing 50-year 94 tracer activity, Ag^+ and HNO_3 for a half-hour at $70^\circ C$ until the characteristic brown color of Ag^{++} was developed. Osmium carrier was then added and the temperature raised to $90^\circ C$ for a half-hour, ozone being passed through continuously. No 94 activity showed up in the distillate of osmium tetroxide, but 81% of the activity was recovered in the non-volatile residue, of which 3% was in the reduced, or fluoride-insoluble state, and 97% was in the oxidized, or fluoride-soluble state.

Last week Brown and Hill found that approximately 80% of the fission

7/15/42

product activity of UF_4 samples irradiated with neutrons can be volatilized together with the uranium when subjected to a fluorine stream at 450° - $500^\circ C$. It should be noted that the 20% fraction of fission products left behind could cause serious complications in scaled-up chemical operations because of the intense radiations. Although much information is known about the behavior of individual fission product fluorides in macroscopic amounts, experiments must be performed to determine if minute concentrations in uranium behave in the same way. And what are the elements associated with the volatile fraction and what elements remain behind as non-volatile fluorides? This was the analysis that Brown and Hill attempted to make today.

Brown fluorinated a gram of the neutron-bombarded UF_4 at $450^\circ C$. The volatile products were collected with uranium hexafluoride in a trap maintained at $-78^\circ C$. They were then dissolved in water and standard chemical separations were made on the solution without rigorous quantitative separations. The residue was dissolved in nitric acid and then, after adding carriers chemically, analyzed for its constituents by measuring the fission product radiations. The following percentages were determined in the residue: rare earths plus yttrium, 65%; barium plus strontium, 25%; and rubidium plus cesium, 10%. Precipitation with lanthanum carbonate should remove 90% of this activity, that is, all except the rubidium and cesium. This precipitation was tried, with results which agreed with the 90% figure. It appears from an earlier investigation that 94 (lower oxidation state) carbonate may be soluble under these conditions, and so this may offer a method for isolating 94 from all fission products except rubidium and cesium. It is relatively simple to separate 94 from rubidium and cesium by any of several precipitation reactions. Next, Brown and Hill will analyze the volatile fraction for the fission products present.

I sent a letter to Wahl asking him to submit a short report on the half-life determination of plutonium-239 through the chain $29 \rightarrow 39 \rightarrow 49$ ($U^{239} \rightarrow Np^{239} \rightarrow Pu^{239}$). "I am continually asked questions," I wrote, "about the conversion electrons in 39, the possibility of gamma ray in 29, the calibration of the Geiger counter in our experiment, etc., by people who want to make sure that we have taken these items into consideration."

7/15/42

Compton, I informed him, has given a contract to A. C. G. Mitchell of the Physics Department, Indiana University, to measure the ratio of conversion electrons to beta particles in 93^{239} and U^{239} (by coincidence counters and spectrographic methods) in order that there might be an independent determination of the half-life of 94^{239} . Mitchell, therefore, is anxious to become familiar with our work, another reason for writing it up.

Then I said, "We are using 50-year 94 tracer at such a rate that I am afraid we will need another bombardment in the not-too-distant future. Perhaps you or Gofman will arrange to have a target made for us; I have sent Gofman some thorium for the preparation of a thorium target for deuteron bombardment, so that perhaps he knows who is doing this vacuum furnace work over in the Radiation Laboratory. I will send you some metallic uranium as soon as I can locate some; we are still having trouble in getting hold of this material."

From the war front on the Pacific comes news of a U.S. victory at Midway; eighty Japanese ships were routed.

Thursday, July 16, 1942

English took a uranium target to the University of Chicago cyclotron and asked Arthur H. Snell to schedule a deuteron bombardment. The deuteron beam from the cyclotron here has an energy of only 8 Mev, compared with 12 Mev from the Washington University 45-inch cyclotron in St. Louis and 16 Mev from the University of California 60-inch cyclotron in Berkeley. English will compare the yield of 50-year 94 here, if any, with the 94 deuteron-uranium yields from the other two cyclotrons in order to determine which 94 isotope is responsible for the 50-year half-life.

Winstein wrote from Los Angeles that, after deliberating a long while, he will have to turn down my offer to come to Chicago for the present. He said the teaching problem at UCLA is difficult and that the administration is pretty much against releasing men unless they are truly indispensable, and in all fairness he can't claim to fall into that category.

7/16/42

Mitchell and I were responsible for tonight's Thursday evening program intended for Research Associates. We met from 7:45 to 9:15 in Room 251, Ryerson Laboratory. He reported on his work on the determination of the proportion of conversion electrons in the decay of 93^{239} , and I gave a report on the progress of the work in my section and at Berkeley on the nuclear properties of 94^{239} , 50-year 94, etc.

Friday, July 17, 1942

Cefola began experiments on the precipitation of microgram quantities of lanthanum fluoride (LaF_3). Ordinary capillary cones and pipettes used in the ultramicrochemistry are made of soft glass. It is apparent that these would be attacked by the HF used in the precipitation process, and so it is necessary for Cefola to get around this handicap. In successive order he has tried coating the glass with paraffin, collodion and varnish; but these failed in preventing the HF from attacking the glass. Now he has pipettes and cones made of quartz which he is testing with concentrated HF. If he finds they are not etched, he will next determine the lowest limit at which the precipitation of lanthanum fluoride can be observed.

Ghiorso sent me a letter saying that he has accepted Stearns' formal offer. He wrote that his acceptance was prompted almost entirely by the fact he will be working in the field that he likes among friends whom he likes. His earlier decision to volunteer for radar work in the U.S. Navy was based on sheer boredom with his routine job of making Geiger counters. I am glad that we were able to rescue such a valuable man for our project, and I don't think he will be disappointed with what is in store for him. I sent him a reply, expressing my pleasure, and saying that "I am sure you will like the work very much; it is an extremely interesting and important project, and you will be connected with one of the most interesting phases of it.... One of the first problems that we will face is the development of a very high resolving power linear amplifier outfit. Mr. Stanley Abrams and Mr. Charles Blanchard of my group in the Chemistry Department at Berkeley have made substantial progress in the development of such an outfit, and I think that we would gain time if you were to get in touch

7/17/42

with their work on this problem. Helen and I are looking forward to seeing you and Wilma as soon as possible."

Ray Stoughton's letter was the bearer of good news. Just as Kamen has promised, the 60-inch cyclotron at Berkeley is now back in business and our thorium nitrate sample is receiving a good neutron bombardment. The sample went in Thursday of last week and soon will be removed for chemistry.

Ray went on to say that he has ordered the additional fifty pounds of thorium nitrate according to my request of June 30. He described the results of working up the two neutron-irradiated samples of thorium-fluoride he sent us June 29 for fluorination for his thorium-uranium separation and which we returned the same day. The distillate from the fluorination yielded 25-35% of the uranium, and that which remained in the thorium fluoride residue was successfully extracted by digestion with fuming sulfuric acid. He also reported that 23 micrograms of Pa²³¹ were obtained from the carnotite ore residue obtained from Morris Perlman and Bonner. He said that he, Wahl and Duffield would like me to send them past and future copies of the notes from my course (Tuesday evening lectures) in nuclear chemistry. These are the notes prepared by Coryell which are already available individually for a number of the lectures and which will soon be available as a total package.

A package of three assorted samples was airmailed to Kamen today, and I asked him to place it as near to the beryllium target of the 60-inch cyclotron as he can because I want these samples to absorb as many neutrons as possible during the next month or so. I couldn't refrain from adding the following: "Joe Hamilton called me up again yesterday and talked me into another interruption of the St. Louis bombardment. I hope his work is as important as he claims it is; if so, we have the Germans on the run."

For some time I have been mulling over, and perhaps fretting over, the need for a systematic program for an early study of the fission products. Today I dictated a three page memo called "Proposed Program for

7/17/42

Investigation of Fission Products." Coryell's group is gearing up for a very basic approach to the fission product problem; it may be some time before they get around to identifying the many fission products, a knowledge of which we sorely need in order to develop a separation process for 94.

My memo suggests a five-part program, viz.: (1) A search for new fission-product activities with half-lives of the order of weeks and months. The known fission products formed with slow neutrons and with fast neutrons of medium energy occur mainly in two groups of atomic numbers, 35-43 inclusive and 51-58 inclusive. A strongly active fission product sample, such as the fission-product fraction from the present St. Louis or Berkeley bombardments, would be subjected to a "standard" chemical separation so as to isolate these 17 fission product elements into a number of chemical fractions, each containing one (or two or three) of these elements. The decay of these fractions could then be studied. (2) Absorption measurements to determine the energies of the beta particles and gamma rays from these chemical fractions. (3) Study of the relative yield of the various fission products, especially of the longer-lived ones. (4) A search for fission product elements with atomic numbers just below 35 and just above 58, and in the region 44-50 inclusive. (5) An investigation of the use of fission products as radioactive poisons. A very simple procedure for isolating the majority of fission products from uranium might be worked out if the 94 is sacrificed.

There are a number of matters I want to discuss with Latimer; so I tried to phone him at his office in Berkeley late this afternoon, but he had already gone home. One in particular concerns the pilot chemical extraction plant for 94 that we are asked to think about and about which I have some ideas. A meeting is being held tomorrow to go over tentative plans. Tomorrow I will write him a long letter.

The temperature today rose to 100°F at four o'clock, the hottest July 17 in Chicago in weather bureau history.

Saturday, July 18, 1942

The matters I took up in my letter to Latimer today were these:

(1) How to cope with the Berkeley reports. Allison wants Latimer to send me his weekly reports for registration, reproduction and distribution here; and, strictly speaking, Latimer is not supposed to retain even a carbon copy. (2) I reviewed the Berkeley role in the fast-neutron fission program (but not including the theoretical aspects being investigated by Oppenheimer's group). Gofman and Duffield will measure the relative Ra-Be fast-neutron fission cross section for U^{233} , U^{235} , U^{238} , 94^{239} , and maybe Pa^{231} ; Gofman and Duffield or Kennedy's group will measure the photo-neutron fission cross sections for the same isotopes; and Manley here at the Met Lab will arrange for the measurements of the same cross sections using a new set of samples, at various laboratories that have monoenergetic artificial neutron sources. Gofman's measurements are awaiting the arrival of the one-gram Ra-Be neutron source, which the Canadian manufacturers promise to send to Berkeley very soon. (3) One man should continue to work on the ore problem under Bonner's direction, and a replacement should be sought for Bonner when he leaves. Someone, perhaps Duffield, should be taught Breslow's technique to produce seven-day U^{237} . (4) Professor Eastman should be enlisted to help on the Project; and I suggested that he undertake the problem of separating 94 by electrolysis. (5) I agreed with Latimer that Professor Rollefson's help would be invaluable. Perhaps he could assist Garner and Wahl determine the kinetics of the oxidation of 94, or work on the preparation of metallic 94. (6) Hamaker ought to visit us next month to become familiar with the work of the microchemists so he can order equipment for a similar set-up for Berkeley. (7) I told him of the decision to erect a new chemistry laboratory here on the Chicago campus, which will be used for research and development. (8) The pilot extraction plant, upon which work will begin very soon. I said, "The planning of this is a rather difficult assignment, since we do not yet know what sort of procedure we will use in the extraction of 94. I therefore decided to make provision for three types of extraction: (a) the fluorination method, (b) the peroxide precipitation method, and (c) any method involving the oxidation and reduction principle. By the latter I mean any method which makes use of the difference in properties of the

7/18/42

two oxidation states, such as HF precipitation, electrolysis, solvent extraction, etc. Naturally, this is rather vague so that we can only plan for the most general equipment, such as large stainless steel reaction vessels, precipitation vessels, etc. It is felt that in order to save time we must take a chance and go ahead with the construction of some very general equipment using the best guesses that we have at this time."

I made a general comment that the work of the Met Lab is being taken more seriously as time goes on. "We now enjoy the highest priority of any defense effort in the country. This includes the production of airplanes, synthetic rubber, etc. This information should, of course, be treated with the most extreme degree of secrecy. And so far as secrecy is concerned, it is felt that the work is now at the most critical stage with respect to the possibility of the obtaining of useful information by enemy agents."

I had just finished dictating the letter to Latimer. My office window was open to catch what breeze there was, and I heard a great hubbub in the nearby "attic" portion of Jones Laboratory. When I went there, I found Covey, Vogwill, Bowers and Jilek in a state of agitation. A storage box containing phosgene gas was tipped over by mistake by Vogwill and Bowers on the roof area adjoining the attic, then righted by Covey and the others and they all feared they had been gassed. Apparently Vogwill was using the box as a platform to stand on in order to peer over the roof parapet at some passing girls down on the quadrangle below when the box tipped. Unknown to them, or to any of us, this old box contained some phosgene of very old vintage. So I took the four of them to Billings Hospital and left, as no reaction is supposed to set in for a few hours. Later when I called they seemed to be okay, but they will be held overnight in the hospital for observation and can report back to work on Monday.

When I returned from the hospital I wrote to Wahl, saying that I mailed him some powdered uranium metal yesterday to be used for a deuteron bombardment of about 3,000 microampere-hours and for any other purpose he sees fit. I also sent a telegram to Stoughton, referring to the thorium nitrate, "How many microampere hours do you plan to give it?"

7/18/42

My group designation this week was changed from Group I to Group C-V.

Cefola is satisfied that his quartz micropipettes and microcones are not attacked by HF. This is fortunate because quartz, unlike soft glass, will therefore not introduce new impurities. So today he was able to continue his work on the precipitation of microgram quantities of lanthanum fluoride.

To appreciate the work of ultramicrochemists, it is pertinent to make a few general remarks about their precipitation techniques. In carrying out analyses at the ultramicroscale level, the concentrations of solutions and reagents are kept the same as those employed in ordinary analysis in order to approximate chemical conditions that exist in the analysis of large samples. The volumes used, consequently, are of the order of 1 λ to 10 λ (1 cu mm to 10 cu mm) when the weights of the chemicals are in the range of microgram (γ) amounts.

Reactions are carried out in tiny centrifuge cones (of 1 λ or 2 λ capacity) in a moist chamber which is placed on a mechanical stage of a microscope. The chamber is kept moist to prevent the rapid evaporation of such small volumes of liquids. Because of the small volumes that are handled, all operations involving the measurement of volumes and the transfer of matter must be done mechanically. For this purpose a micro-manipulator which gives varied motions by means of rack and pinion devices is employed.

For measuring the extremely small volumes of liquids, calibrated capillaries and eyepieces with micrometer scales are used. The transfer of such volumes is then made by means of micropipettes (operated with a plunger device) which have quite a long shaft and an opening of 30 to 40 μ (30 to 40 $\times 10^{-4}$ cm). These micropipettes are made from capillaries with the aid of a mechanical device. Precipitates formed in the small capillary cones may be observed with either transmitted or reflected light, using low power magnification (about 30x to 50x). The supernatant liquid may be separated from the precipitate by centrifuging, placing the cone back into the moist chamber and removing the liquid by means of a micropipette.

Cefola, in his experiments on the precipitation of lanthanum fluoride measured out 10 m λ (0.01 cu mm) of La^{+3} solution (10 mg/ml) in a measuring

7/18/42

capillary and then transferred it to a quartz capillary cone. The solution contained La^{+3} as $\text{La}(\text{NO}_3)_3 \cdot 6\text{H}_2\text{O}$. To this he introduced an excess of 6 N HF by means of a micropipette also made of quartz. The flow of liquids in or out of this pipette was controlled by mouth instead of a plunger device such as usually employed. He next placed the cone containing the excess reagent and precipitate in a larger capillary. The latter was sealed and stirred by means of a buzzer and then centrifuged for five minutes. At the end of this period he placed the cone under a microscope (35x magnification) and examined it with transmitted light. The precipitate that had collected at the tip of the cone was white and gelatinous and could barely be seen. He then used reflected light and the existence of the precipitate became more obvious. All the manipulations except centrifuging were carried out in a moist chamber. The amount of La^{+3} precipitated was equivalent to 10^{-7} gram, or 0.1 γ (0.1 microgram) which is close to a lower limit.

The meeting I attended at 2:00 this afternoon to consider tentative plans for the so-called "Chemical Plant" lasted two hours. Besides myself, others present were Boyd, Brown, Compton, Moore, Perlman, Potratz, Ruhoff, Spedding, Steinbach (a consulting engineer brought in by Compton), and Whitaker. Ruhoff, who was recently commissioned in the U.S. Army and then posted back at Mallinckrodt in St. Louis, presented tentative building plans for a pilot chemical extraction plant for element 94 based on his experience with the U_3O_8 refinery at St. Louis. He proposed that sufficient space be provided at once for trying three processes, the three types of extraction that I have recommended (fluorination, peroxide precipitation and any method involving the oxidizing and reducing principle), so that each process would be capable of handling one ton of raw material per day. He personally favors starting "all out" on the best process adaptable to a 100,000 kw pile as determined from large-scale laboratory experiments. He also favors starting a little later on the second process. The third space is to be reserved in case of contamination of one of the first two spaces, or to contain the third process should the first two present serious difficulties. I defended Ruhoff's plan by saying that any plan ultimately adopted for the chemical isolation of 94 would undoubtedly be based on one of the three extraction schemes under consideration. By recommending the three methods of 94 extraction for the pilot plant, I

7/18/42

have cast the die. It is just three months to the day that I have been working here. If the times were not so perilous, this indeed would be a brash decision.

Ruhoff listed three essential qualifications for buildings and equipment based on the assumption that making repairs may be hazardous or impossible during the time of operations. (1) Simplicity, which will require a minimum of mechanical maintenance. (2) Capability of lending itself when possible to remote control. (3) Must in some instances be completely shielded, keeping in mind the practicability of pits. His plan includes the three chemical separation areas of 10,000 square feet each, plus shops, laboratory, warehouse, living quarters, storage pits for cooling off prior to or during processing and to serve as emergency dumps, and facilities to dispose of noxious gases. Most of the discussion related to radioactivity hazards and safety. Perlman pointed out that large barriers, which could be moved by machinery, might be desirable. Spedding suggested covers for tanks containing active materials, and Compton agreed. Spedding reminded us that the plan as suggested is purely tentative and is intended to serve as a starting point and a basis for further study and discussion.

Sunday, July 19, 1942

After spending the morning reading and writing reports in my Jones Laboratory office, I joined Helen at home for lunch, then walked with her to nearby Washington Park, just west of the area in which we live. The near (eastern) boundary of the Park is Cottage Grove Avenue. We strolled throughout the Park observing the large number of people who decided to spend their Sunday afternoon in the same manner.

Monday, July 20, 1942

Perlman and Knox completed an experiment begun on Thursday on thorium peroxide as a carrier for 94. In this preliminary experiment today--the precipitation of 94 with partial precipitation of uranium-thorium peroxides--

7/20/42

the precipitate was treated with sodium hydroxide solution so that the uranium peroxide would dissolve, leaving behind only the thorium peroxide. The solution from which precipitation took place was 5 cc in volume, 0.05 N in HNO_3 , and contained 700 counts/min of 50-year 94, 100 mg of UNH, 2.5 mg thorium nitrate and 0.25 cc 3% H_2O_2 . The solution was boiled to bring down the thorium peroxide and an estimated 10-20% of the uranium as peroxide. This precipitate was centrifuged and the uranium peroxide dissolved in 3 cc of 1 N NaOH, leaving only thorium peroxide. All three fractions were then analyzed for 94 activity. Of the 94 added, 11% remained in the filtrate from the peroxide precipitate along with 80-90% of the uranium after peroxide precipitation, and 86% was found with the thorium peroxide.

Brown and Hill completed their analysis of volatile products that resulted from their experiment last Wednesday. They showed that the radioactivity in volatile fraction was composed of 27.8% bromine and iodine, 35.8% antimony and columbium, 14% technetium and molybdenum, 22.2% zirconium and 0% selenium and ruthenium. The fact that selenium (atomic no. 34) and ruthenium (atomic no. 44) are missing from both the volatile and non-volatile radioactive products is not surprising. This is consistent with the generally accepted view that no appreciable amounts of elements with atomic numbers below 35 or in the group 44-50 are formed in fission by slow or medium-fast neutrons. The results obtained are about what one would expect, for all of the elements found are known to possess volatile fluorides, and they have sufficiently long-lived radioactive isotopes formed in fission.

Alan A. Jarrett, who received his A.B. at the University of California at Los Angeles, is the latest Research Assistant to join my group. He started today and will work on the instrumentation connected with our counting apparatus, making his headquarters our counting room, Room 402.

The time has come for Wahl to work up the 210 pounds of UNH that was bombarded with neutrons in the Berkeley cyclotron from April 24 to June 20 for a total of 40,000 microampere-hours. The radioactivity has died down so that there is only a fraction of a curie of fission products remaining.

7/20/42

A substantial quantity of 94^{239} should have been synthesized, which Wahl will try to isolate in its entirety by ether extraction, followed by a series of lanthanum fluoride oxidation and reduction cycles. The task is formidable, but he has the necessary skill and experience.

Wahl sent us a 97-gram sample of the neutron-bombarded UNH, which we received early this morning. Perlman wants to use some of it to study the behavior of long-lived fission products in peroxide solution. This material is ideal because it contains only long-lived activity; the uranium received an intermittent bombardment over a period of two months, after which the short- and medium-lived activities were allowed to decay for a month. Perlman and Knox ground and mixed this material and then weighed out 500 mg, which was dissolved in 100 cc of water. Two 1 cc portions were removed (each containing 5 mg of bombarded UNH) and precipitated with 1 cc of 3% H_2O_2 in lusteroid tubes. In keeping with earlier results on medium-lived products, 18% of the total fission activity, all long-lived, was found in the uranium peroxide precipitate.

Stoughton sent a telegram in response to my inquiry about the thorium neutron bombardment. He said that it was completed last Wednesday midnight with 15,000 microampere-hours.

A letter came from Fontana in Berkeley, telling me that he has completed the task of combining several U^{234} electroplates and that the final plate is now in the hands of Gofman. He credited Sheline and Prestwood with help in attaining their success. The plate has a U^{234} content of 1.48 micrograms, the equivalent of 17,800 total alpha particle disintegrations per minute. He also told me the anticipated yield of additional U^{234} from the UX_1 samples currently on hand will, in a month, amount to two micrograms, and after that he will continue to recover, on a regular basis, UX_1 and daughter U^{234} from his uranyl nitrate sources.

Fermi has an idea that UX_1 (U^{234}) or UY (Th^{231}) may undergo spontaneous fission at a rather high rate--at least he thinks the possibility is worth checking experimentally. He phoned me to ask if I could arrange to make a simple experimental test and I said I will ask Gofman to do so. The

7/20/42

reason for this thought is an unexpectedly high background of neutrons from some of the uranium he has been working with, and he thinks this might be due to spontaneous fission of UX_1 or UY .

I telephoned Gofman in Berkeley and wrote him a confirming letter about the conditions to observe when he looks for spontaneous fission decay in UX_1 and UY . I suggested he have Prestwood or Fontana give him a sample of UX_1 from their supply and prepare the sample of UY from one pound of UNH.

About two years ago Dunning of the Physics Department, Columbia University, made some fission measurements on protactinium. I remembered the fine linear amplifier that he had used; so I wrote to him today requesting a copy of the wiring diagram. In our counting of fissions on top of very high alpha particle background, we need an instrument with high resolution. I reminded him of our talks to the American Chemical Society in Chicago on May 8 and his promise to let me copy his slides. Those in which I am interested concern various apparati for producing nuclear reactions and his summary of elementary constants and concepts of nuclear reactions.

I wrote to my UCLA classmate, Harlan Baumbach, a chemist in Pacific Palisades who is working for Paramount Studios, and asked if he would be willing to join my group at the Met Lab. Although I couldn't tell him the nature of the opening, I did reveal that my group is working on a war research project which is probably "Number One" in the country. Then I swore him to secrecy, saying: "This work is of a very secret nature, and I must ask you not to discuss with anyone, at least for the present, the fact that you have been offered a position with us. We are trying to keep as secret as possible the location of the project and the nature of the personnel." I told him about my marriage six weeks ago and went on to say, "It seems to me that probably I ought to collect a ten-dollar bet from you; but unfortunately I can't remember making such a bet."

I saw the Met Lab "Report for Week Ending July 18, 1942." Among other things it states that on Tuesday of last week Whitaker and Zinn's group

7/20/42

received the first ton of purified U_3O_8 from Mallinckrodt, and by Friday 3.5 tons had been pressed into three-inch diameter cylinders and the construction of intermediate pile No. 9 was completed. Wigner reports that most members of his theoretical group were engaged last week in calculations concerning water-cooling of the planned production pile. Young worked on the heat transfer aspects; Weinberg, Plass and Williamson on the reproduction factor; and Christy and Wigner on the change in neutron migration length and on the size of the production plant. Friedman of his group had an interview with an M.D. about radiation dosage. He was told that the usually quoted 0.1 roentgen per day for permanently permissible dosage is probably very low and could be increased by a factor of 10. Specifically, one r per day to the whole body is tolerable for at least two months, 10 r per day can be taken for 3 or 4 weeks, and a dangerous massive dose is probably several hundred r. It was also averred that no effect of previous radiation will remain after three months and radiation sickness from a massive dose has no permanent ill effects. Of course this is one man's opinion. I think some definitive research should be done before this information can be trusted.

In this same report Doan summarized the uranium oxide and metal situation. To date a total of about 28 tons of D-1 oxide (uranium oxide specially purified, triply leached) have been received from the Port Hope refinery of the Canadian Radium and Uranium Corporation. All 28 tons have been sent to Mallinckrodt in St. Louis for further purification by their ether extraction method. We have received back about five tons of black oxide and 3,200 pounds of extracted nitrate. Of the oxide, 1,000 pounds has been sent to Alexander's in Beverly, Massachusetts, for metal production (by reduction of uranium oxide with calcium hydride), 7,000 pounds pressed into briquets here for the exponential pile and the remainder held in stock. Of the nitrate, 1,000 pounds were sent to Westinghouse in Bloomfield, New Jersey, for metal production and the remainder held in stock. Westinghouse metal is being produced by the electrolysis of KUF_5 , which is obtained by a photo-chemical reaction of uranyl nitrate and potassium fluoride carried out in the presence of sunlight on the roof of their building. The maximum capacity for the production of KUF_5 when there is a full quota of sunlight is 400 pounds per day, which yields 100 pounds of metal. At the

7/20/42

present time the production rate of uranium metal by electrolysis of the molten KUF_5 is about 60 pounds per day. Westinghouse now has on hand 750 pounds of metal, mostly in the form of hemispherical lumps two inches in diameter. The greatest single problem to date is obtaining suitable crucibles for induction casting of the metal. Beryllium oxide is the most suitable material found thus far, but these beryllium oxide crucibles last for only two or three melts and then have to be sent back to be made over into new crucibles. The crucibles themselves are made by the McDanel Porcelain Refinery Company of Beaver Falls, Pennsylvania, but their supply of beryllium oxide is limited by the production rate and capacity of the Brush Beryllium Company. The production rate of metal can be increased to 300 pounds per day by using UF_4 instead of KUF_5 , and arrangements are now being made by Westinghouse with Harshaw Chemical Company to supply the necessary UF_4 .

Around five o'clock Covey came into my office and asked me if I would like to inspect our new facilities for the ether extraction and recrystallization of neutron-bombarded UNH when we receive it from the St. Louis cyclotron. (In the meantime we will use the equipment to purify some unirradiated UNH from Mallinckrodt Chemical Works that we have on hand in preparation for later neutron bombardment at one of the cyclotrons.) Our labs and my office are on the west and south end of the fourth floor of L-shaped Jones Laboratory and nearly east of us is the attic, a large barn of a room presumably a space once intended to be sectioned off into laboratories but used in the meantime as a storage room. A door opens from this space onto the roof, the area where we can extend our work space during clement weather if necessary. Covey had followed directions well. I saw where he had pushed aside lots of old discarded equipment to make elbow room and space for several tables and had cleared away many shelves. On one of the tables was a tall lead shield, and there was a stack of lead bricks on the floor as well as a pile of old newspapers. In scrounging around, Covey had found some huge evaporating dishes two feet in diameter and several one-, two- and three-liter separatory funnels in the stockroom, evidently left behind by some faculty member formerly engaged in handling large volumes of chemicals. In addition, I saw an accumulation of much glassware, water buckets, empty five-gallon carboys and several hot

7/20/42

plates. The plumbers had run in a water line and tap, and the electricians had put in the required electrical outlets. I hoped to see a laboratory hood, but Covey said none was available; so he has set up some work tables, a steam table and hot plates, along with the evaporating pans, on the roof area in the open air. Here is where the reduced volumes of UNH in the water phase will be recrystallized by evaporating over the steam table and hot plates. Plenty of ventilation will be needed because of the ether and acid fumes, plus all the water vapor liberated. It all looked very primitive considering the sophisticated subsequent chemistry we will carry out on the neutron-irradiated uranyl nitrate.

Tuesday, July 21, 1942

My weekly report this week is designated "Group V: Chemistry of 94." Apparently as part of the reorganization of the Chemistry Division last month my group was given the designation "Group V," and I didn't catch up with the change until the last few days. The group designations for Spedding's people are: I, Boyd; II, Burton and T. W. Davis; III, McCoy; IV, Coryell. In my "Report or Week Ending July 18, 1942" (No. CC-198), I include the investigations of Perlman, Jaffey, Willard, English and Brown. In addition to what I have already written in my daily accounts, their further studies are reported. I report Jaffey's experiments on the precipitation of 94 with rare earth iodates. In an experiment with Ce^{+3} , he finds that, as with La^{+3} , 94 does not come down quantitatively with small amounts, but probably does to the extent of 75-80%. The use of Ce^{+4} as carrier and the effect of two or more $La(IO_3)_3$ precipitations will be investigated next.

I also report that English, in addition to his investigation of the ozone-argentic ion solution, has found that 94 bromide, like 94 chloride, is non-volatile from either aqueous distillation or dry distillation at high temperatures.

I report Willard and Turk's experiments on the Tswett columns, in which aqueous solutions are passed through columns of one cm inside diameter. They find that when the column is packed with three grams of Hyflo Super Cel, 84% of the 94 is adsorbed and no uranium at all. Because

7/21/42

it is necessary to recover the 94, a leaching experiment showed that 75% of the 94 could be flushed out of a column by using 6 N HNO₃.

I include the report of Latimer's Berkeley group, his first. This consists of descriptions of a study by Hamaker of the oxidation of 94 by K₂S₂O₈-Ag⁺, which demonstrates nearly complete oxidation in less than a minute at room temperature, and a study by Wahl of the Wet Fluoride Method for separating 94 from uranium and fission products by successive rare earth fluoride precipitations from reducing and oxidizing media.

Brown came into the office this afternoon very excited about the results of an experiment that Hill has just performed under his direction. Until today, their research has shown that 94 cannot be volatilized in a fluorine stream together with UF₆ if the 94 is introduced into the UF₄ (used in preparing the UF₆) by the so-called "wet" method. (In this method the 94 is added to a solution of uranyl sulfate and the solution is reduced with zinc. Hydrofluoric acid is added and the 94 precipitated quantitatively with the UF₄. The UF₄ is dried and then fluorinated.) When this procedure is followed, the 94 remains quantitatively behind and the uranium disappears as a gaseous fluoride, UF₆.

In today's experiment, 94 was introduced into the UF₄ prepared by the "dry" method, i.e., by hydrofluorination of uranium oxide. Several thousand counts/min of 50-year 94 was added to a solution containing 0.25 gm of uranyl nitrate. This was evaporated to dryness and converted to the oxide (U₃O₈) by heating. The U₃O₈ was treated with hydrogen at 500°C, giving UO₂. The UO₂ was in turn hydrofluorinated (treatment with anhydrous HF) at 500° and thus converted to anhydrous UF₄. Small samples of this UF₄ were weighed to be fluorinated at various temperatures. To their amazement, when they fluorinated the first sample at 500°C, they discovered that both the uranium and 94 volatilized completely. Then, when they fluorinated a sample at 250°C, they learned that element 94 fluoride is somewhat less volatile than the UF₆. This changes the entire aspect of the fluorination method but makes it no less applicable as a potential way of separating 94 from uranium and fission products.

Tomorrow, Brown will start a long series of experiments on the

7/21/42

neutron-bombarded uranyl nitrate that we received yesterday from Wahl. The purpose is to identify the long-lived fission product elements. Some of the work will be done in collaboration with Perlman. These elements, especially, must be recognized in order to make the final purification of 94 from the pile feasible.

Some of the Project's uranium oxide comes from a mill at Port Hope, where Canadian and Belgian ores are refined by a private company, the Eldorado Gold Mines, Ltd., of Canada (represented by the Canadian Radium and Uranium Corporation in New York City). This morning, Compton introduced me to Bertrand L. Goldschmidt, a radiochemist who has been working for Eldorado at Port Hope and will be part of my group for the next month or so. Dr. Goldschmidt, like von Halban, was associated with Joliot in the Curie laboratory in Paris until Germany occupied France two years ago. While in New York he volunteered his services to the Fighting French Scientific Group, and last week through the Free French Delegation of New York, was hired by the Department of Scientific and Industrial Research of Great Britain. The DSIR immediately assigned him to the Met Lab for the next few weeks to become familiar with the chemistry of 94 and other facets of research at the Lab. Compton, however, prefers that the information he gathers be confined to chemistry under my guidance.

Goldschmidt, in talking to me, quoted Compton as saying that the most precious secret he will learn here is that 94 fluoride is insoluble. The Germans do not have a cyclotron powerful enough to produce 94, even if they know about its existence, and so might be ignorant of its properties. He also told me that DSIR reserves to itself complete control of all his results and complete ownership of his inventions and discoveries during the tenure of his appointment. Perlman took him in hand and introduced him around to the other men in my group and explained what each one is doing. Goldschmidt and I were born in the same year, and although he is older than the others, we have a happy bunch; so he received a cordial welcome. I will have him work at laboratory bench no. 2 in Room 404, the same area where Perlman is working.

I am anxious to pursue the idea of using zirconium phosphate as a

7/21/42

carrier for plutonium, and I think Goldschmidt is the right man to investigate it. He was told by the DSIR that he may be transferred to Great Britain in a few weeks. If he stays with me, I think I will ask him to help Brown and Perlman in their work with long-lived fission products in view of his radiochemical experience.

I attended a meeting of the Engineering Council, along with Allison, Doan, Fermi, Hilberry, Leverett, Lewis, Moore, Wheeler, Whitaker, Wigner, Wilson and Wollan. Today we had the privilege of hearing the views of Warren K. Lewis of M.I.T., who is considered to be the dean of U.S. chemical engineers. I have had a number of talks with him and shown him much of the laboratory work on our extraction processes for 94. Today designs for the fission power and chemical extraction plant were reviewed. Lewis noted that, if a decision on an extraction method has to be made at the present time, fluorination should be chosen, not because it might prove the best, but because it is the one for which there is the most experience. He thinks the peroxide method leads to bulky, slimy precipitates that are difficult to handle and process of precipitating small amounts of lanthanum fluoride also leads to difficulties. He agreed with our plan to provide for all three processes in our chemical extraction pilot plant. He recommends putting each of these processes into sustained operation on as large a scale as possible in the laboratory—pick as soon as possible foremen, sub-foreman, operators and try to go into a three shifts a day operation with dummy batches. Fermi emphasized the need for a radiologist to help with our health protection problems and Hilberry said it is hoped to get K. S. Cole to join the project.

I have decided that the time has come to hold research progress meetings with the senior members of my group. I met this evening in my office with Brown, Cefola, Cunningham, Jaffey, Magel, Perlman and Willard to discuss this possibility, and they are enthusiastic about the idea. We will meet on Tuesday evenings in my office in Room 403, Jones Laboratory. This means that it will be somewhat crowded, but this is the most convenient place for us to meet.

Wednesday, July 22, 1942

In their continuing study of a suitable adsorption method for separating 94, Willard and Turk are investigating today the effect of increasing the length of a Tswett column using Hyflo Super Cel (HSC) adsorbent. They find that a 1 cm diameter column packed with 6 gm (15.5 cm) of HSC is capable of removing nearly 100% 94 from 50 cc of 10% UNH with only 7% of the uranium. The 94 may then be quantitatively recovered by a 6 N HNO_3 wash.

These conclusions are the result of an experiment in which 50 cc of a 10% solution of the hexahydrate containing 50-year 94 tracer was introduced at the top of a column of HSC. The solution was allowed to flow by gravity, until it reached the bottom of the HSC. A gentle suction was then applied, and successive portions of the solution collected. The volume of each portion and time required for its collection were recorded. Aliquots of each portion were analyzed for 94, and uranium and the percentages of each of these elements which were removed from the solution in its passage through the column were determined. The amount of 94 removed varied from 100% to 94%; the amount of uranium removed varied from 17% to 3%, with an average of 7% over the 50 cc of the solution.

I wrote a friendly letter to another UCLA classmate, Stanley G. Thompson, in Berkeley. I told him of my marriage to Helen and reminded him that last winter Helen and I had dinner with him and his wife Alice in their house in Berkeley. Thompson, whom I have known since we were freshmen in high school, got his A.B. in chemistry at UCLA eight years ago and has been working for Standard Oil Company of California in Richmond, California, ever since. I said to him: "Would you care to accept a position with me here, probably to work for the duration of the war? In such a case you probably would want to take a leave of absence from Standard. The work here is extremely important, perhaps the number one war research project in the country, and it is of such a character that it will almost certainly have post-war significance and develop into a large industry. I mention the latter because it shows you there is some possibility that you would find a more agreeable permanent position with this project than your present position with Standard. Unfortunately I cannot divulge

7/22/42

to you the nature of the work but, knowing the nature of my activities in the past, you are in a fair position to guess. As I said above, it is research work of the most interesting type; it is the most interesting problem upon which I have ever worked."

Manley sent me an interdepartmental note verifying that he will take care of circuit development for counting fissions over high alpha emission rates, with assistance from me in supplying drawing of circuits of English and Dunning, and will make fission measurements on samples I am to supply, using thermal, Ra-Be and D-D neutrons.

Gofman will certainly be pleased to get the letter I wrote to him today. I said that his one-gram radium-beryllium source was shipped to him yesterday by Railway Express. I asked him to check with Hamilton what to do with the old, leaky one-gram Ra-Be source. We brought this in March, before I left Berkeley, from the Canadian Radium and Uranium Corporation but immediately ran into trouble with a leak of radon gas, rendering the source useless.

Thursday, July 23, 1942

Magel and Koshland continued their solvent partition experiments for the separation of 94. Today they ended another experiment (their sixth) with ether as the organic solvent, with the consistent result that less than one percent of 94 is extracted by ether when the 94 is in its lower oxidation state. LiNO_3 was used as the "salting out" agent. When the 94 is in its upper state, about 75% is removed from the aqueous solution by ether. In the experiments with 94 in its upper state, oxidation was carried out by passing Cl_2 into slightly alkaline aqueous solution of 94 plus salting-out material for 30 minutes at 80°C . They also tried nitromethane and nitropropane, but these organic solvents were not as effective as the ether. They will next investigate whether or not fission products can be separated from 94 by a combination of oxidations and ether extractions.

Hamaker and I had an exchange of telegrams regarding his plans to

7/23/42

visit Chicago. I suggested that he delay his trip for two weeks until our microchemists are more completely set up. I think he will be better informed if he can see the complete layout and observe our men in action.

Allison wants Latimer to send his weekly reports directly to me. In this way the Berkeley and Chicago reports on "Chemistry of 94" can be sent out together. I made this known in a letter to Latimer, and I requested him to use our section headings when possible. In regard to Hamaker's visiting us, I suggested that Hamaker should buy a round-trip ticket to New York, since he will undoubtedly want to go there to purchase equipment after talking to Cefola, Cunningham and Werner here.

I finished writing up a report on our Berkeley fast neutron fission measurements, which I dispatched to Gofman for his and Friedlander's comments before publication as a Project report.

Manley and Coryell were responsible for the Research Associates program tonight. We met for an hour and a half, as usual in Ryerson Laboratory.

Friday, July 24, 1942

Hamilton called me from St. Louis this morning in regard to the UX_1 concentrates that are coming up as a by-product of the Mallinckrodt UNH purification plant, which will be sent to the Berkeley chemistry group. Ruhoff has agreed to go through three ether extraction cycles on some of this material. This will leave a concentration of small weight with hundreds of millicuries of UX_1 in it and constitute material of the highest specific activity received so far. Ruhoff will treat the final concentrate with water so that there will be two fractions: (1) the water insoluble part and (2) a fluoride precipitate from the water soluble part.

Hamilton also informed me that our neutron bombardment of the 300 pounds of UNH at the Washington University cyclotron ended day before

7/24/42

yesterday. It started June 17, 1942, and received 49,419 microampere-hours bombardment. We should expect its arrival at the Met Lab in a few days.

Truman P. Kohman, who just completed his graduate work in chemistry at the University of Wisconsin, arrived in Chicago from Madison on the 11:35 train this morning and went through the hiring rigamarole in the afternoon to start with us as a Research Associate. As soon as we receive the bombarded material from St. Louis, I will ask him to work with Jaffey to direct the efforts on the 94^{239} extraction. This operation will take place in the "attic" and adjoining roof area, which Covey and his assistants have been putting into shape.

Hamilton will be back in Berkeley next week to give details of the UX_1 concentrates shipment to the fellows there, but I thought it best to tell Latimer about it in a letter that I sent off after the call. My chief reason for writing, though, was to tell Latimer about a complete table of precipitation reactions for 93 and 94 that I am preparing. In making it, I was struck by the many gaps and how much work is facing us on the precipitation reactions alone. I went on to say, "It would certainly be useful to find an element that carried 94 in a precipitation which was entirely unique to that element. For example, and this is mostly only to illustrate what I mean, suppose 94 were carried by zirconium phosphate from highly acid solutions. Zirconium (except for bismuth) has the only phosphate which comes down from highly acid solution; and therefore, if 94 was carried by this precipitate, it could be separated from the total mixture of uranium and fission products together with only one fission product, namely zirconium, from which it could be easily separated. If this unique carrier element were not a fission product, it would be even better. Incidentally, we actually are investigating the possibility of zirconium phosphate in this regard." I concluded my letter by remarking that Mallinckrodt is going to charge him \$1,000 for the UX_1 concentrates.

With regard to phosphate as a carrier, it seems to me that if zirconium phosphate should not prove to be feasible, then perhaps bismuth phosphate could be tried.

7/24/42

Helen and I took a cruise on Lake Michigan in the evening. It was cool on the boat but very crowded.

Saturday, July 25, 1942

Gofman sent me a telegram concerning the spontaneous fission rate of UX_1 ; he observed no counts in 18 hours of counting-time, using an amount of UX_1 equivalent to 200 grams of uranium. I relayed this information to Fermi by memo right away.

Hamaker showed up unexpectedly and was full of news about the group back home in Berkeley. He did not receive my night letter advising him to delay his trip and get a round trip to New York, which is unfortunate because he will now have to return directly to Berkeley, after his visit next week with Cefola, Cunningham and Werner. At 12:30 Hamaker and I went to lunch in the Hutchinson Commons cafeteria on the University of Chicago campus in the pleasant company of Goldschmidt, Cefola and Covey.

There was a meeting of the Technical Council, attended by Allison, Compton, Doan, Fermi, Moore, Szilard, Wheeler, Whitaker and Wigner. Fermi reported on a new value of k , the reproduction factor, of 1.004, from measurements made on Mallinckrodt-purified D-1 uranium oxide. He hopes to gain 0.024 by using Speer Carbon Company graphite, 0.008 by removing nitrogen, and 0.005 by using UO_2 in the form of pseudospheres, a total k estimated at 1.04. The value of $k = 1.004$ was determined from exponential pile No. 9 measurements. This pile was assembled as a test of the reproduction factor that can be obtained at present with the use of very pure U_3O_8 from Mallinckrodt. It is believed that no significant impurities are left in this product and so any increase in k must come about by substituting UO_2 for the U_3O_8 . This pile has the same geometry as pile No. 5, that is, there are cylindrical lumps of pressed oxide in an eight-inch cell-side cubic lattice. The graphite used is the same as that used in No. 5, so that the only difference between the piles No. 5 and No. 9 is the change from D-1 oxide to Mallinckrodt oxide.

7/25/42

There was considerable discussion about the procurement of uranium metal from Alexander and Westinghouse and the effects of radiation on mice and men. Compton reported his visit of several hours to the National Cancer Institute last Monday, studying their work. There is no change in heredity in mice down to the fourth generation when exposed to 0.1 roentgen per day. At 0.5 r/day, there are some still births, and this leads to death after 1,000 r; it takes 200 r to sterilize a female and twice that much to sterilize a male. A physician at the Chicago Tumor Institute estimates that a concentrated dose of 100 r in man would not be seriously harmful and that an irradiation of 10 r would lead to detectable effects in a blood test. Whether the dosage is 1,000 r or ten times that much, a mouse will die within a week. The other danger to watch out for is leukemia, which can develop from large dosages of radiation. Compton thought we might have similar problems with personnel at the pilot plant if we don't know the tolerance dosages for man, and Moore advised setting up hospital facilities there.

Sunday, July 26, 1942

Rostov, a city of a half million people and key to the oil-rich Caucasus, is in grave danger of falling to the Germans.

Monday, July 27, 1942

It has previously been shown that when 94 is adsorbed on Hyflo Super Cel columns, it may be quantitatively eluted with 6 N HNO_3 . In order to determine whether or not more dilute solutions of acid might be used, Willard and Turk, during the last couple of days, have washed columns containing adsorbed 94 with 20 cc of HNO_3 solutions of different concentrations. The time of passage of 20 cc was in each case about an hour. Their results indicate that solutions 1 N or 2 N in HNO_3 elute about 70% (compared to 100% for 6 N) of the 94 from HSC, whereas with 0.002 N HNO_3 the elution drops to 12%.

7/27/42

Willard and Turk have continued their experiments involving the use of Hyflo Super Cell adsorbent for separating 94 from uranium. In today's experiments, for example, they are using a 40% concentration of UNH in a Tswett column and varying the amount of HSC to determine the optimum amount for 94 adsorption. In the practical extraction of 94 from uranium it is desirable to keep the volume of solution small, and therefore the concentration of uranyl nitrate high, for convenience and speed in handling. The results show that in working with concentrations varying from 10% to 60%, the adsorption ability for 94 drops off sharply at concentrations higher than 30%.

Thompson was prompt in answering my letter of last Wednesday. In his salutation he said, "Your marriage is to some extent a surprise, although I cannot say it is a complete one. When you and Helen visited us, we felt her to be a very warm and attractive person. Our sincerest congratulations!" He said he would be very happy to take a position with us, and for the duration of the war. "Actually," he said, "I am more than thrilled over this matter and you will understand that it is very important to me that I would be doing something really worthwhile in contributing to a worthy cause." He believes he can make arrangements with his present employer, Standard Oil, in a week or so, but that if I need him sooner, he will come and leave Alice behind to handle their business affairs.

Lawrence wrote to me from the Radiation Lab in Berkeley. He needs copies of my two letters written to Briggs of NBS concerning the discovery of element 94 and measurement of the properties of 94^{239} and he asked if I could oblige him.

I heard from Gofman regarding his intention to measure fast neutron cross sections for the isotopes U^{233} , U^{234} , U^{238} and Pu^{239} . He received the stick of thorium I sent him July 15 but was disappointed that it was not in sheet form so that it could be easily mounted on the steel target. He wrote that, based on alpha-particle emission, a rough calculation shows that the half-life of U^{232} is 50-years. In order for him to be sure the alpha emitter is not 93^{232} or 94^{232} resulting from the beta decay of U^{232} ,

7/27/42

he will make a chemical analysis. He said that I will soon receive a report on the slow neutron fission of U^{234} and that he has already mailed me the final report on the spontaneous fission of U^{234} . He asked my advice about what amount of U^{234} must be accumulated to start further spontaneous fission measurements on this isotope.

This morning a truck pulled up to Jones Laboratory bearing the 300-pound shipment of neutron-irradiated UNH from the St. Louis cyclotron. The UNH was surrounded by a layer of lead bricks. Kohman and Covey were detailed to unload the shipment and carry it up to our lab on the fourth floor for extraction of the 94^{239} . The UNH crystals came packaged in small boxes of various sizes, made to fit into the various niches around the cyclotron target. Some of the boxes were made of masonite, but most of them were of quarter inch plywood. Unfortunately, some of the seams and edges had cracked open, allowing crystals of hot UNH to creep out. We could not get hold of any instrument to measure the radioactivity. I told Kohman and Covey their best protection would be to wear rubber gloves and a lab coat when coming in contact with the crystals, and to stay far away from the boxes whenever they could. Although they struggled for half the day to get all the boxes and lead bricks upstairs into the storage area, I think they were conscientious and kept their radiation exposure to a minimum.

Kohman, in his methodical way, wants to make some trial runs on the separation and measurement of element 94. He is preparing himself for the big job of extracting 94 from the neutron-irradiated UNH we received today, which should start in about two weeks when the fission-product activity has been appreciably reduced by decay. This afternoon he began an experiment using one ml of 50-year 94 tracer solution (350 counts/min) and 100 mg of unirradiated UNH for his starting material; he will use the oxidation-reduction procedure with lanthanum fluoride as carrier.

Tuesday, July 28, 1942

Kohman finished his trial isolation of element 94. After evaporating

7/28/42

the final water-suspended lanthanum fluoride to dryness in the bottom tip of a centrifuge tube, it was mounted in a cardboard ring with Scotch tape and placed in one of our ionization chambers (which is connected to a linear amplifier, scaling circuit and recorder). He had hoped to recover all 350 counts per minute, but found a loss of about 12%. He will try again, this time making sure to get the final precipitate spread uniformly on the bottom of the tube, which he hopes will allow him to count all the activity and indicate he has achieved 100% chemical recovery.

Perlman and Knox have been engaged off and on during the month in a series of experiments using thorium as a carrier for plutonium in peroxide solutions. In earlier experiments they have shown that the total precipitation of uranium peroxide from a solution of uranyl nitrate and fission products removes 94 quantitatively; however, almost 20% of the fission activity comes down with the uranium. Most of the activity appears to be associated with fluoride insoluble substances, so non-active lanthanum was added as a "hold-back carrier." Nevertheless, the amount of fission activity that still comes down in the uranium peroxide is reduced by a factor of only two or three. Rather than refine the method of total precipitation of uranium, they decided to try another possibility, namely, the carrying of 94 with thorium peroxide.

In today's experiment, 1 mg of thorium was precipitated from a 5 cc solution containing 94 and which was about 0.1 N in nitric acid. The solution was analyzed for 94 activity and found to contain 7% of the original 94. The thorium peroxide precipitate showed that 74% of the total 94 activity was present in it, leaving 19% of the added 94 unaccounted for. Similar experiments will be repeated.

Work on the solvent partition method is being continued by Magel and Koshland. They have completed two separate experiments to separate 94 from a mixture of uranium and fission products using diethyl ether as the solvent. They started with a solution containing 9.0 cc of saturated LiNO_3 , 0.5 cc of 94 tracer in the lower oxidation state (328 counts/min of alpha activity), and 0.5 cc of fission products (10,000 counts/min of beta activity) plus uranium (about 3 mg UNH). According to the concept of the

7/28/42

method, when this mixture is extracted with ether, the uranium goes into the ether layer, leaving behind nearly all of the fission products plus the 94 in its lower state. Next, since the aqueous layer is then slightly alkaline, Cl_2 is passed into the solution, which oxidizes the 94 to the higher state. This mixture of 94 in the higher state and fission products is then extracted with ether, whereupon the 94 goes into the ether, leaving behind the fission products. They find that there were only 40 counts/min of beta activity accompanying the 94, that is, virtually all of the fission products are removed. It was shown that essentially all the alpha activity in the ether solution is due to 94 by taking an aliquot part and performing a lanthanum fluoride precipitation. The alpha count on this when evaporated to dryness was almost the same as the count from another aliquot part that had not been precipitated. In other words, the final product was a nearly pure ether solution of 94. The duplicate experiments did not give identical results in the amount of 94 in the ether layers and for that reason they will repeat these experiments. Similar experiments using nitroparaffins for the organic solvent are also in progress.

Breslow dropped in to see me. He said that after leaving the Berkeley project, he came to Chicago yesterday to join one of the groups engaged in war research. He raised the question as to whether or not we should try to make, by the Szilard-Chambers method he and Hamaker have developed, a strong U^{237} sample for A. Carl Helmholtz at the Berkeley Rad Lab to measure its radiations with his magnetic spectrometer; the problem here is the heavy schedule of the Berkeley cyclotron. Connick is now a member of the Berkeley 94 group and is taking over this part of the work. I indicated that perhaps this should be his concern.

I replied to Lawrence today, sending him copies of letters that he is seeking. I sent him a copy of the May 29, 1941, letter to Briggs describing the first observation of the slow neutron fission of 94^{239} , which was published as an official Report No. A-33. I also sent copies of our original two letters concerning the observation of 94 from deuteron bombardment of uranium: the first to Abelson dated January 28, 1941 (with a copy to Briggs), and the second to Briggs on March 7, 1941. (The work

7/28/42

on 94 from deuteron bombardment of uranium was described more fully in a later report, A-136, March of this year.) I took this opportunity to request some cyclotron time, saying, "We are consuming 50-year 94 here at a higher rate than I had anticipated, and we will need some more in about three weeks. Since the yield at Berkeley is some five to ten times higher than at St. Louis, it is more efficient to make it at Berkeley. I wonder if you could squeeze a 3,000 microampere-hour deuteron-uranium bombardment into your heavy schedule? Joe Hamilton made up the previous targets for us, and he told me, during his last visit to the East, that he would gladly take care of this part of it for us."

Garner sent a letter from Berkeley, transmitting a preliminary report on the work with ores, which he and Bonner finished about two weeks ago, and commenting that the evidence suggests the presence of some isotope of 94 (presumably 94^{239}) in the carnotite to the extent of 123 alpha particle counts per hour. The definitely negative results (absence of alpha particle activity) in the 94 fractions from fergusonite and hatchettolite, he wrote, lend support to the supposition that the procedure and technique satisfactorily eliminated uranium and thorium isotopes originally present in the ores. He and Bonner talked to Wahl about the possibility of making rough alpha particle range measurements on the final carnotite precipitate to attempt to establish whether the activity was due to 30,000-year 94 or a much longer-lived isotope. Wahl replied that since the activity of their sample is so slight (123 counts per hour in excess over the test precipitate) it would be very difficult and too time-consuming to make the experiment of any value. He said Gofman will make neutron tests of the 94 fractions within a week or two to establish if there are detectable quantities of any other fissionable isotopes of 94 present in the 94 fractions; this is a much less sensitive test than alpha particle activity in the case of 94^{239} . Garner is of the opinion that continued work on the ores by the present method is not worthwhile from a war-time point of view and declared his personal preference for full-time studies of the oxidation potential of 94.

In my "Report for the Week Ending July 25, 1942. Group C-V: Chemistry of 94" (No. CC-199), I report on the work of Magel and Koshland on the

7/28/42

Solvent Partition Method for Separating 94 and the work of Willard and Turk on the Adsorption Method of Separating 94. Latimer's report for the same period covers Garner's and Hamaker's work on Oxidation Reactions of 94, Duffield's work on Precipitation Reactions of 94 and Bonner's and Wahl's work on the Wet Fluoride Method for Separating 94.

This evening we held a meeting in my office of the Research Associates in my section. Attending the meeting were Brown, Cefola, Cunningham, Jaffey, Kohman, Magel, Perlman and Willard. We have been so favorably impressed with Goldschmidt, who has started to work so effectively and fits in so well with our group, that I have decided to include him in these Tuesday evening meetings. The purpose of the meetings is to go over with each of the fellows the status of his research program and to make plans for the next experiments in these programs. Tonight Cunningham and Cefola made a review of the status of their ultramicrochemical program-- they plan to make an attempt soon to isolate a compound of pure 94. Kohman and Jaffey described their plans for the ether extraction of the 300 pounds of neutron-bombarded UNH which arrived from St. Louis yesterday. Perlman reviewed the status of his work on the peroxide process, Willard the status of his work on the adsorption process, Brown the status of his work on the fluoride method, and Magel the status of his work on the solvent extraction method.

Wednesday, July 29, 1942

We now have on hand 300 pounds of neutron-irradiated UNH from St. Louis that arrived day before yesterday. Our group not only needs experience in the ether extraction procedure for such huge amounts of material, but we have to purify more UNH for another bombardment at the St. Louis cyclotron. So today, while waiting for the UNH shipment to cool down for the next week or so, Jaffey, Kohman, Turk and Koshland, set to work in the attic area on the 300 pounds of unirradiated, unpurified UNH from Port Hope that we have been holding in storage. They will attempt to purify this uranyl nitrate by the ether method, and Covey and his assistants will be called in to help when necessary.

7/29/42

The Port Hope UNH consists of large lumps and apparently is not immediately suitable for ether extraction. Fifty-pound batches, therefore, were melted with a little water in the large glass and porcelain evaporating dishes. An attempt was made to achieve a proper density (2.4 for crystallization by evaporating or adding water. Porcelain chips have about this density, and the proper concentration was arrived at when the chips just floated. A batch was then cooled with constant stirring in order to produce as small crystals as possible. Those that would not pass through a 20-mesh screen were remelted in the next batch. After they finish with recrystallization of the 300 pounds they will proceed to ether-purify it.

Kirk, of the Division of Biochemistry, Berkeley, wants to develop an ultramicrobalance for us and is trying to get financial assistance from Lawrence to take a six-month leave-in-residence. He sent me a letter today saying that his arrangements with Lawrence are going ahead satisfactorily and he expects to start work about the first of August. Cunningham and Werner have been investigating the possibilities of a Salvioni balance (the heart of which is a quartz fiber that deflects according to the weight attached) and have made three prototypes already. In addition they have collected a considerable body of data on such characteristics of the Salvioni balance as stability, sensitivity and reproducibility. The principal fault of the Salvioni balance is that it has a low total load capacity—about 300 micrograms—which requires pans and weighing vessels of sufficient lightness. It is for this reason we hope that Kirk will come up with something superior on an improved magnetic or capacitance principle; however we will go ahead and construct the best Salvioni balance we can. An Emich (refined Angstrom) balance is also under construction, but this may take longer to complete.

Thursday, July 30, 1942

Rough chemical separations have been carried out by Brown, Goldschmidt and Perlman on the fission product mixture associated with the neutron-irradiated UNH sample received from Wahl last week. It is probable that

7/30/42

this fission mixture will not be greatly different from that obtained from the proposed chain-reacting pile.

The rare-earth-like fraction was found to represent the largest contributing group of elements. Analysis showed it to contain approximately 65% of the total gamma activity (all measurements being carried out through 11.5 grams of lead). Of this 65%, about 25% can be attributed to yttrium, 40% to lanthanum and 2% or less to cerium. The lanthanum activity is largely due to the daughter of 12-day barium, barium itself containing no noticeable gamma-activity.

Approximately 30% of the total gamma-activity was found to be divided almost equally between columbium and zirconium. Element 43 was found to contain about 5% of the gamma activity. The other elements tested, namely rubidium and cesium, bromine and iodine, krypton and xenon, antimony, strontium, molybdenum, tellurium, as well as cerium and barium, were found to contain little if any gamma-activity (~2% each).

The rare earths were precipitated as fluorides, the cerium removed as iodate, and the lanthanum and yttrium were separated by potassium carbonate precipitation of the lanthanum. A comparable figure for the total rare-earth-like activity was found by measuring the residue after fluorinating the fission mixture. This residue also contained the alkaline earths and alkali metals, which were later found to be essentially inactive. By volatilization methods, the rare gases and bromine and iodine were found to contain negligible activities. The results on the bromine and iodine were confirmed independently by silver halide precipitation. Tellurium, antimony, 43 and molybdenum were precipitated as sulfides and were later separated. Tellurium was separated by SO_2 reduction, 43 and antimony by reduction with zinc (and tin), and molybdenum reprecipitated as the sulfide. Antimony was separated from 43 by volatilization as SbH_3 .

Zirconium and columbium were analyzed in two different ways with essential agreement. First zirconium was precipitated as the phosphate from strongly acid solution and columbium by fuming the HF solution with HNO_3 . Secondly, the columbium and zirconium were volatilized from the rest of the fission products by hydrofluorination (treatment with anhydrous HF) at 500°C of the ignited activated uranyl nitrate. The

7/30/42

volatile fluorides were collected and separated by carbonate fusion which leaves columbium in a soluble form.

Hamilton informed me by telegram that Gofman and Duffield have received the one-gram radium-beryllium source, and I replied by letter, saying, "You inquired in your wire as to how you might help us within the near future. We will need, within the next week or so, another uranium plus deuteron bombardment. I have sent the powder to Wahl, and in a letter to Ernest I mentioned the matter to him. Kamen is spending a day or two in Chicago, so I took advantage of that opportunity to mention it to him. In my letter to Ernest, I suggested that you probably would make up the target for us. I suggested a bombardment of 3,000 microampere-hours; but, if the cyclotron is not too busy, it would probably be more efficient to give us some 5,000 or 6,000 microampere-hours; then we will not need to bother you again very soon. We will want the target shipped to us so that we can do the chemical separation here.

"Perlman received a letter from Ruhoff today in which Ruhoff said that the fluoride precipitation at St. Louis will be delayed pending the arrival of a sufficient amount of potassium fluoride.

"As you probably know, Wahl is now working with Professor Latimer, and they are now adding more members to the group working on the chemistry of 94."

Next I wrote to Latimer and enclosed a carbon copy of a letter I just sent to the FBI in an effort to expedite Friedlander's citizenship. Not only is Friedlander having problems with the Immigration Board, but now he is having trouble with his draft status. I said that we should make every effort to save him for this work. "We were very interested in reading your second weekly report," I went on. "I think the arrangement whereby your group does the most fundamental work in this problem is a good one since we are more or less forced to take more practical points of view in our work here in Chicago."

7/30/42

I also wrote to Ghiorso about the details of his travel arrangements and reimbursement and asked him to confer with Friedlander about our Berkeley ionization chamber and FP-54 electrometer outfit so he will be well equipped to construct such an outfit for us in Chicago.

I replied to Gofman's letter I received last Monday. I stressed the importance of the fast neutron cross-section measurements he and Duffield are making and said I am confident they will do a good job. I agreed with him that U^{234} should be included in his measurements and that Manley should work with an independent set of samples for his measurements. I returned his report on spontaneous fission of U^{234} with some changes that I want him to check.

We had the usual Thursday evening meeting for Research Associates. This time Whitaker and Spedding were responsible for the program.

Friday, July 31, 1942

Urey wrote me the following note from OSRD in Washington, which I received today, "I have been much interested in your reports on the Hydrogen Peroxide Method for separating 94 and should like to suggest that you add carriers for your radioactive material and precipitate. The final plant will produce a considerable concentration of these radioactive carriers and they may not be adsorbed on the precipitate, but if they are, then an addition of practically all of the elements of the middle part of the periodic table and subsequent precipitation would prevent the adsorption of 94. I think that you have probably thought of this, and that the next report will show that you have done it, but just in case you may overlook it, I am sending this note."

I received a letter from Latimer expressing satisfaction with the way things are moving in Berkeley. He thinks that Eastman will fit nicely into some of the work and be able to act as a buffer on administrative problems that might arise in his absence. There is a strong possibility, he said, that he will spend a third or more of his time around Chicago

7/31/42

this fall. I suppose he means with the Northwestern University project, dealing with gas warfare.

Another letter received from the Berkeley Department of Chemistry was from Mabel Kittredge, the departmental secretary. She said that on the basis of the letter I wrote in June in behalf of Friedlander (and which Professor Latimer says is pretty close to the borderline of being a penitentiary offense), he was put into 2A draft (deferral) status until December 1. She said that he isn't bothered by the imminence of induction into the U.S. Army, but rather of finding a job after August 7, when he is through teaching in Summer Session--Friedlander heard that a ruling has just come through from Washington that no alien born in Germany can work on any problem connected with the Army or Navy; so he went to the FBI, where it was confirmed.

This afternoon I had a pleasant surprise when Compton brought Professor Kasimir Fajans from the University of Michigan to my office and introduced us to one another. My only other contact with this pioneer in the investigation of radioactivity by chemical means has been through our correspondence. Because of his security clearance I was able to show him our laboratory and describe some of the work going on. He seemed to be impressed with what we are doing. Compton has extended him an invitation to join us at Chicago as a member of the Laboratory Council and general consultant and supervisor of all chemistry groups.

At last there is a bit of good news from the Russian front. The Reds have driven the Nazis back on two sections of the Don River--by Voronezh and by Kletskaya.

AUGUST 1942

Saturday, August 1, 1942

Jaffey, Kohman, Turk and Koshland have finished with the recrystallization of the Port Hope UNH and are now experimenting with its ether purification.

Recrystallized UNH is measured out in one-liter amounts and placed in three-liter separatory funnels, along with about 1.5 liters of ether, and shaken vigorously until all the salt dissolves. (At this stage, most of the uranium nitrate dissolves in the ether in the form of trihydrate, leaving $3\text{H}_2\text{O}$ out of the hexahydrate to separate into the water phase along with many impurities, which would include elements 93 and 94 and fission products in the case of UNH that has been neutron-irradiated.) After the ether and water layers are separated, the water layer is removed to be combined with other water layers. The ether is rinsed with 15 ml of water, which removes considerable amounts of insoluble matter. The purified uranyl nitrate remaining in the ether layer in the funnel is then recovered by extracting with several portions of water, usually in successive amounts of 600, 600, 600 and 200 ml, when the ether becomes clear again. Several hundred ml of fresh ether are then added to the funnel to bring the total volume back to 1.5 liters and a new batch of UNH crystals added. Unfortunately, after much use of the same ether, it takes on a yellow cast, presumably due to stopcock grease and other impurities; so it becomes difficult to ascertain the endpoint of the water extraction.

Hamilton wrote from Berkeley and asked me to send him all available information to date about radioactive krypton and xenon from uranium and thorium fission. He is interested in conducting some physiological experiments and thinks these radioactive gases might be useful. He is seeking rare-gas isotopes with half-lives greater than 36 hours that decay by emission of gamma or annihilation radiation.

8/1/42

Our supply of 50-year 94 tracer is running precariously low. I was pleased, therefore, to learn from Hamilton that my powdered uranium sample will receive the 3,000 microampere-hour bombardment at the 60-inch cyclotron I asked for, and within the next three weeks. In my letter to him last Thursday I pointed out that a 5,000 or 6,000 microampere-hour bombardment would be more efficient; because of the urgency, I repeated this in my reply today. I also said that I had no good news regarding the krypton and xenon, that the few experiments we have performed here, though crude, show there are no very long-lived rare-gas activities. "The only possibility at all for your purpose," I continued, "would be the 5.4-day Xe^{133} of Wu and Segrè, but there is nothing known about the gamma rays from this. Incidentally, the particles are very soft, of range a mg or so, indicating that it is a converted isomeric transition, and this might indicate that the gamma rays, if any, would be very low energy unconverted ones." In closing the letter I replied to Joe Kennedy's alleged concern about my being forced to eat vegetables, as a result of my recent marriage, by saying it is true—that every day at lunch I have potato chips!

Yesterday the Met Lab received its first large shipment of UO_2 from Mallinckrodt, and pressing of the material was begun immediately. Intermediate pile No. 10, which is to compare U_3O_8 with UO_2 , will be completed early next week in the West Stands.

The Planning Board meeting was held today, attended by Compton, Doan, Fermi, Hilberry, Moore, Spedding, Szilard, Wheeler and Wigner. There were discussions of cooling the experimental plant and the possibility of using uranium carbide in the pilot plant and how the carbide could be produced. Compton appointed a committee to take up the problem of carbide production and asked Doan to confer with Union Carbide Company in New York on Monday. Toward the end of the meeting he disclosed that the Army is taking over responsibility for clearance and security, but that H. T. Wensel (Technical Aide, Section S-1) will carry on as our agent in authority. Zinn raised the question as to who is authorized to see the pile in the West Stands. Compartmentalization of information will also continue. Although we must obtain

8/1/42.

authorization to give information to visitors and the Navy, we may talk with Urey and Lawrence about anything, and they, like Compton, can authorize us to confide in any of their men. Compton also said that all copies of "A" reports must go through Wensel's office to Army, Executive Committee and British, six copies in toto, and it is Conant who has the final authority on the distribution of information.

The front page of the newspaper is depressing today. The Reds are retreating deeper into the Caucasus, and ten thousand Japanese troops are reported to be in the Aleutian Island area.

Sunday, August 2, 1942

Today the Chicago Sun reports more grim news from Moscow. The Soviets say that the Nazis are 112 miles into the Caucasus, "below fallen Rostov."

Monday, August 3, 1942

The target that English submitted to Snell for bombardment by the University of Chicago cyclotron's 8 Mev deuteron beam consists of a 3-1/2 inch diameter, 1/8-inch thick steel plate with grooves into which uranium metal was fused. It has been bombarded for a total of 288.1 microampere-hours, beginning Wednesday, July 22, and continuing off and on for seven non-consecutive days until yesterday afternoon. English received it this morning and obviously from its appearance, all of the beam was focused on the uranium.

English and James set to work and dissolved off the uranium by washing the target repeatedly with concentrated (16 N) HNO_3 . The solution was then evaporated down with HNO_3 nearly to dryness three times. Later this week the solution will be divided into two parts: one part will be treated to yield element 93 and the other will be treated to yield the 50-year 94, if such were created by the 8 Mev beam.

8/3/42

An interesting experiment was performed today by Willard and Turk. Using a 1 cm in diameter Tswett column containing 12 grams of Hyflo Super Cel, they took 3 gm of the St. Louis irradiated UNH, dissolved it in 7 cc of water, adjusted the pH to 2.7 (increasing the volume of 9.5 cc) and allowed the solution to flow into the column with the aid of suction; then 20 cc of 30% UNH was added to wash the solution through. Their purpose was to determine whether or not the fission products could be separated from 94 and uranium by the adsorption method. To their delight they found, by counting a sample of the solution that came through the column, that 80% of the beta and gamma radiation originally in the sample passed through the HSC column. Previously they showed that 95% of the 94, under similar conditions, would be retained by the column. Thus it is tentatively concluded that an HSC adsorption process will separate 95% of 94 from at least 80% of uranium fission products (two weeks old), as well as from about 95% of the uranium in a uranyl nitrate solution of suitable concentration and pH.

Since they began work early last month, Cunningham and Werner have constructed and tested several Salvioni balances. They have now constructed a satisfactory Salvioni balance and developed techniques for quantitative weighing on the microgram scale. The Salvioni balance (Figure 8) consists essentially of a fine (~0.06 mm diameter) quartz fiber, 12 cm in length, one end of which is rigidly mounted. The fiber is protected from air currents by a suitable housing. The free end of the fiber bears a hook, to which may be attached suitable weighing vessels or pans. Deflections of the free end are measured by a micrometer slide cathetometer, accurate to 0.002 mm over a range of several millimeters. Under these conditions, a precision of weighing of approximately 0.01 microgram is attainable. An ionizing source (uranium or pitchblende) is kept inside the balance case to prevent the accumulation of troublesome static charges. An adjustable vertical stop, by means of which the free end of the fiber may be maintained in any desired position, is essential to the manipulations of weighing.

Because the total load capacity of such a balance is low (around 0.3 mg), weighing vessels and pans are necessarily very small. A suitable weighing vessel was constructed from platinum foil 2.5×10^{-3} mm in thickness. The shape of the vessel is that of a shallow pan with a short handle.

8/3/42

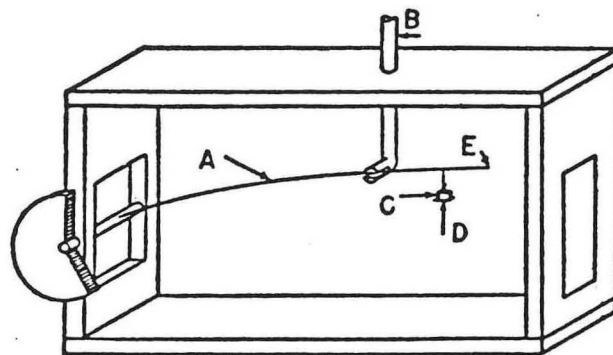

(MU 13765)

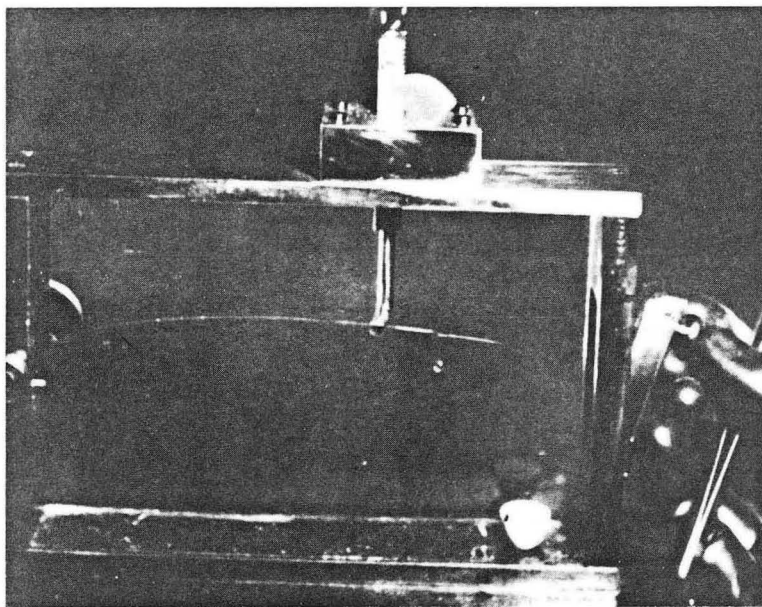

Fig. 8 Salvioni Balance. Top-schematic diagram. A: Quartz fiber; B: adjustable stop used in loading; C: aluminum cradle for weighing pan; D: platinum weighing pan; E: position of fiber read by microscope. Bottom-photograph of balance. The weighing pan and support (not shown) are attached to the right end of the horizontal quartz fiber. (XBB 768-7445)

8/3/42

Approximate dimensions are 1.0 x 1.5 mm. The weighing pan is hung from the fiber by means of an aluminum carrier, the shape of the carrier being that of an inverted U with a long (3-4 mm) tail attached to the bottom part of the U. The arms of the U are bent upward to form a cradle for the weighing pan and the end of the tail forms a hook for attachment to the fiber. The weight, cradle plus pan, is around 0.2 mg.

It was found impossible to manipulate these pieces by hand satisfactorily. A pair of simple micromanipulators therefore form part of the equipment for weighing. One of these bears a glass rod, the end of which is formed into a shallow trough in which the aluminum carrier rests. The second is equipped with a screw-controlled forceps and is used for removing the pan from the cradle. Manipulation of pan and cradle and addition of substances to be weighed must be performed under the microscope at about 30x magnification.

The first ultramicrochemical experiment of Cunningham and Werner will be to try the co-precipitation of tracer amounts of 50-year 94 with microgram amounts of lanthanum oxalate.

More ether separations of the Port Hope UNH took place today. It was found that it is most efficient to dissolve four pounds of UNH in two liters of ether. After withdrawing the water layer and washing the ether layer with 20 milliliters of water, the uranyl nitrate can then be recovered from the ether by successive extractions using 500, 700, 800 and 500 ml of water. Evaporation of the water layers was also continued.

Fifty pounds of Mallinckrodt purified UNH was obtained from West Stands. Two 25-pound bottles were selected that contained salt having the appearance of hexahydrate. The whole amount was placed in an evaporating dish and heated overnight. The reason for using the Mallinckrodt UNH is to compare its purity with the Port Hope UNH.

A good indication that the planning and construction of the chemical separation plant is under way is that a man has been assigned to take charge of the chemical engineering work on extraction problems. He is Charles M. Cooper, a chemical engineer from du Pont Company, who reported for duty at the Met Lab today. I am scheduled for a meeting with him on

8/3/42

Thursday to discuss what equipment will be needed for the experimental extraction plant.

A telegram arrived from Gofman, which I acknowledged, regarding the spontaneous fission rate of UY (thorium-231). He observed zero counts in 10 hours, using an amount of UY equivalent to about 0.1 kg of uranium. This is the measurement requested by Fermi, which I will relay to him. I wired Gofman that his results are sufficient and extended our thanks to him. A letter also arrived from Gofman in which he commented on some corrections he and Friedlander made to our manuscript that I sent him July 23 on the fission of 94^{239} , U^{233} , U^{235} , U^{238} and Pa^{231} by fast Ra-Be neutrons.

I received a letter from Garner in Berkeley, who reported that Gofman and Duffield have completed tests for fission with slow and fast neutrons on the final ore fractions. Garner's conclusions are that the measurements indicate an upper limit of a fission-capable 94 content of one part in 10^{10} of carnotite, one part in 10^9 of fergusonite and one part in 10^9 of hatchettolite. The aim of these experiments was to look for 94^{239} (or any other fissionable isotope of 94) through its fissionability characteristics. However, the alpha particle activity is a much more delicate test for 94^{239} and the presence of this isotope was established in the carnotite at a concentration of one part in 10^{14} . In pitchblende Morris Perlman and I found alpha particle activity, attributed to 94^{239} , at about the same concentration, which results we described in our report, A-146, dated April 13, 1942, "Search for Elements 94 and 93 in Nature. Presence of 94^{239} in Pitchblende."

George Bowers concluded his service with us as a Laboratory Helper today.

An upturn in the news! The Soviets have smashed repeated tank drives on the Don River, in the elbow northwest of Stalingrad.

Tuesday, August 4, 1942

When the Mallinckrodt UNH was inspected this morning, it was found not to have completely melted, even though heated overnight. A total of about three liters of water had to be added over a period of time to get it all to dissolve while heating continued. More water was added until a porcelain chip would just float. The batch was then cooled while stirring, but as in many times in the past, the crystals that evolved were too wet. A quantity of the Port Hope UNH solution was evaporated to what was thought the right density (determined by pipetting out five ml and weighing), but the crystals from it, too, were not dry. Experiments and tests are continuing.

In my "Report for Week Ending August 1, 1942, Group C-V: Chemistry of 94" (No. CC-216), submitted today, I summarize our research as follows. Perlman and Knox have continued work on the peroxide method for separating 94 by exploring the possibility of carrying 94 with thorium peroxide, on the basis that thorium might be preferentially precipitated with respect to uranium. Conditions have been found where more than 80% of the 94 is carried by the thorium peroxide, with 80%-90% of the uranium remaining unprecipitated; fission activity in the precipitate is found to be about 1% of the total activity. Such a procedure eliminates the need to precipitate all the uranium. Studies to identify the elements associated with gamma radiation from long-lived fission products (with the help of Brown and Goldschmidt) show the major contributors to be lanthanum (40-45%), yttrium (20-30%), zirconium (10-15%), columbium (10-15%), element 43 (5%). Magel and Koshland, working on the solvent partition method for separating 94, have performed preliminary experiments using ether whereby some of the fission products and uranium are first extracted by the ether, leaving the reduced state of 94 in the aqueous phase; the 94 is then oxidized and extracted by a second ether extraction. Results are encouraging in that the final product is nearly pure ether solution of 94; however, the duplicate samples did not check well. Pending the availability of microgram quantities of 94^{239} , Cefola, Cunningham and Werner have initiated ultramicrochemical investigations by carrying out preliminary experiments with 50-year 94 as tracer and using microgram

8/4/42

amounts of carriers. They show that quantitative transfers of 94 tracer with lanthanum fluoride precipitates can be carried out on this scale. Brown and Hill have continued their investigation of the fluorine method for separating 94 by demonstrating that if steps are taken to ensure that 94 is in the form of an ordinary fluoride (e.g., PuF_4) rather than an oxyfluoride (e.g., PuOF_2), the 94 can be volatilized if fluorinated at 500°C but is not volatilized if fluorinated at 250°C . As the uranium is volatilized at the lower temperature of 250°C , this leads to a separation process simpler than previously visualized, whereby pure 94 can be volatilized in a final fluorination after the volatile fission products have been removed by hydrofluorination with anhydrous HF at 500°C and the uranium by fluorination with F_2 at 250°C . Non-volatile fission products would remain behind. Included is the report of Latimer's group covering Oxidation Reactions of 94 by Garner and Precipitation Reactions of 94 by Duffield.

I received a letter from Hamaker in Berkeley concerning 110 milligrams of rhenium he is sending me at my request. He removed it from the Periodic Table box (our complete collection of chemical elements gathered by our chemistry group at Berkeley), as there was no other rhenium to be had. He informed me that Latimer has sanctioned the purchase of all the microchemical equipment needed to equip a new microchemical lab at Berkeley, including an extra microscope. In another vein he told me that Kennedy is to be married next week, and that I seem to have started a new trend: there has been at least one wedding per week since my own in June—Lipkin, Aebersold, Cooksey and John Lawrence among others.

Gofman's data on the spontaneous fission rate of UY was written up and sent to Fermi in the form of a memo.

We held our regular meeting of my group's Research Associates this evening. Much of our talk had to do with the progress of our ultramicro-chemists in building their successful Salvioni balance, etc.

8/4/42

The Russians seem to be standing firm on their whole defense line-- both northwest of Stalingrad and in the western Caucasus--the latter only 138 miles from the oil derricks of Maikop.

Wednesday, August 5, 1942

Using the standard procedure to isolate element 93, English and James have now worked up half of the target material they got last Monday. Their next task is to determine the yield of 93 and see if the 93 fraction is pure, i.e, free of fission products. They will use a Lauritsen electroscope to study decay of the activities and the energies of their beta particles by means of absorption measurements, in order to establish the ratio of 2.0-day 93 and 93^{239} . When this work is completed they will turn to the other half of the sample to isolate what little 94 is present, if any.

"Fission of 94^{239} and U^{233} by Fast Ra-Be Neutrons," by G. Friedlander, J. W. Gofman and G. T. Seaborg, was issued today as Report CF-221. This reports the comparative measurements at Berkeley of the cross sections for fission with fast neutrons of 94^{239} (using the 0.5-microgram sample, sample B, isolated in May 1941, U^{233} (using the 3.8-microgram sample J prepared by Gofman and Stoughton early this year), Pa^{231} (using the 1.04-microgram sample prepared by Stoughton last spring), and U^{238} and U^{235} (using a 200-microgram sample of natural uranium containing 198.6 micrograms of U^{238} and 1.4 micrograms of U^{235} and an enriched U^{235} sample containing 1.3 micrograms of U^{235} and 5.2 micrograms of U^{238}). Our Berkeley one-gram Ra-Be neutron source was used, and the ionization chamber was protected with cadmium and boron carbide in order to eliminate slow neutrons. We find for the fast neutron fission cross section for this spectrum of fast neutrons, all relative to the cross section for U^{235} , the values 1.5 ± 0.5 for Pu^{239} , 1.8 ± 0.5 for U^{233} , 0.9 ± 0.3 for Pa^{231} , and 0.4 ± 0.1 for U^{238} .

Wahl wrote to say that he has been very busy working up the 210 pounds of UNH that has been bombarded with neutrons at the 60-inch

8/5/42.

cyclotron to produce 94^{239} . After several weeks setting up apparatus and experimenting, he and his assistants finally ran the ether extraction on it. They ran it in three batches, dissolving 70 pounds of UNH in 9 gallons of ether in a 12-gallon pyrex bottle. The mixture was stirred with a glass stirrer attached to an induction motor (to avoid an explosion), and solutions were blown from one bottle to another by compressed air. The total time required to extract the 210 pounds of UNH and to re-extract it from the ether was 12 hours. Eight percent of the uranium was left in the water phase from the first ether extraction. He said that he is reserving his opinion until after the run is completed as to the amount of 94^{239} that will be available to the microchemists in my group. He indicated his work on the big neutron-bombarded UNH sample has delayed his writing of the report concerning the half-life of 94^{239} but he will prepare a draft in the near future and send it to me.

Reports from the Russian front today are bad again--the Nazis made a 50-mile advance in the Caucasus, threatening Tikhoretsch, an important junction on the Soviet railway system.

Thursday, August 6, 1942

Latimer arrived in Chicago this morning. He came to my office and we had an interesting discussion regarding the work in general at Berkeley and here. Later my secretary gave me a letter that just arrived from Stoughton in Berkeley. He was perturbed that their project has no A-1-A priority yet, although their secretary, Mrs. Moquin, expects the priority in a week or so, and asked for my help in pushing it through. They are finding it difficult to order equipment and electronic parts. I responded that I would see that something is done about it immediately. My letter also stated that I was pleased his U^{233} separation has gone so well and noted how the U^{233} from this run will be used. (1) A sample of approximately five micrograms will go to Manley here so that he and others can determine the fast-neutron fission cross section of U^{233} , and (2) as large a sample as possible will go to Gofman so that he can measure the spontaneous fission rate of U^{233} . In regard to his problem of separating

8/6/42

small amounts of uranium from large amounts of thorium, I suggested that U^{232} might serve as the best tracer in practice experiments with unirradiated thorium. I asked him to tell Gofman that Fermi extends him his most cordial thanks for the fission measurements made on UX_1 and UY .

Cooper came to my office today for our scheduled meeting. He brought Miles Leverett along and I asked Perlman to join us. The purpose of the discussion was to begin planning for the chemical equipment necessary for the extraction of 94 from the experimental pile. We went on the assumption that the experimental pile will first yield 94 in January of next year, just five or six months hence. The first item on the agenda was the problem of storing hot oxide and metal soon after it is removed from the pile. According to present plans, this oxide and metal will be removed from the pile over a 45-day period, that is, at the rate of one ton per day. It was considered advisable, however, to make plans for the temporary storage of as much as 50 tons of material, should it be necessary. Two methods were considered: (1) storage in solution and (2) dry storage. The amount of uranium in the experimental pile will be 40 tons, mostly as the oxide and perhaps 10% as the metal. A 30% uranium solution in water, i.e., five pounds per gallon, would amount to 16,000 gallons. This much material might be dangerous to handle, especially if there are leaks in the storage tanks, and dry storage might be the answer. Certainly it would be better for the fluorine method if adopted, which requires dry material. Methods of handling the dry material were then considered.

Next we discussed the preparation of uranyl nitrate solution, as most of the proposed methods for extracting 94 will involve the prior preparation of this solution. One of the questions that arose was how to get the uranium into solution and how fast it can be done, a factor in the plant capacity. Because the most favored process at the moment for the extraction of 94 is oxidation-reduction with fluoride precipitation, we proceeded to calculate the size and number of stainless steel tanks that would be necessary. Starting with 1,350 gallons of 5% uranium solution, the oxidation of 94 to the upper state will require 100-150 pounds of $K_2Cr_2O_7$, and one pound of lanthanum will be added as the carrier. After oxidation, a maximum of 240 pounds of anhydrous HF would be employed. Centrifugation or filtration was thought to be the best way of removing

8/6/42

the pound or so of hot rare-earth fluoride. With the filtrate in a 1,500 gallon tank, reduction of the dichromate and 94 would be carried out by adding 200 pounds of SO_2 . The resulting rare earth fluoride containing 94 would then be separated in a similar manner to that in which the first rare earth fluoride was removed. From this point on, isolation would not require plant-sized equipment. We also discussed the disposal of the 1,350 gallons of solution containing one-third ton of uranium and concluded that it should be stored, crystallized and purified by ether extraction. Other processes for the extraction of 94 were gone over superficially, as was the matter of fluorine generators, large power requirements and high pressure steam for heating tanks and evaporation of solutions.

Jaffey, Kohman, Turk and Koshland have continued to try to purify the Port Hope and Mallinckrodt UNH by ether extraction but have run into one problem after another. Since they will have to start to work on the St. Louis neutron-bombarded UNH in a few days, we have decided to prepare the next 300 pounds of UNH for neutron bombardment simply by recrystallizing purified Mallinckrodt UNH. They have obtained 300 pounds of such purified UNH and commenced the recrystallization process.

Anderson and Boyd were in charge of the evening program for the Research Associates. As usual, we met between 7:45 and 9:15 in Room 251 of Ryerson Laboratory. Earlier in the week I gave Anderson five pounds of the neutron-irradiated UNH that came from St. Louis, and he reported that he and Fermi have removed the uranium from the fission products by ether extraction to make a gamma-ray source, which in turn was used to generate photo-neutrons from beryllium. Their measurements showed that the hard gamma rays of the fission products give about the same neutron yield with beryllium as does radium. He also discussed results of a heat transfer study between graphite blocks and progress in some neutron cross section measurements. Boyd talked about the activities of his group. At present they are devoting their time to routine analyses and the development and testing of analytical methods. He believes he and Ercole E. Motta now have a way to determine the boron content of uranium oxide. One member of his group, Herbert A. Potratz, is investigating a means of analyzing for

8/6/42

cadmium in various materials of importance in cooling the pile.

More bad news! The German army has made a new push south and west of Stalingrad, attempting to complete a pincer movement on the great steel city.

Friday, August 7, 1942

Willard and Turk continued their study of the separation of 94 from fission products using Hyflo Super Cel by performing further elutions on their Tswett column following their experiment performed on Monday. This same column was washed with distilled water, with saturated $(\text{NH}_4)_2\text{CO}_3$ solution followed by distilled water, and with 6 N HNO_3 . Counts were made on aliquots of these eluants, which indicate qualitatively that (1) distilled water is ineffective in removing the remaining adsorbed fission products; (2) saturated $(\text{NH}_4)_2\text{CO}_3$ solution removes some of these fission species but is quite ineffective in removing others; and (3) much of the active material that is not eluted with saturated $(\text{NH}_4)_2\text{CO}_3$ solution is removed with 6 N HNO_3 . The results with $(\text{NH}_4)_2\text{CO}_3$ are of interest since it was found previously that 94 is only slightly adsorbed by the Hyflo Super Cel from solutions of uranyl nitrate in saturated $(\text{NH}_4)_2\text{CO}_3$. Willard and Turk conclude that there is a possibility that, if a column containing adsorbed 94 and fission products is washed with $(\text{NH}_4)_2\text{CO}_3$ solution, the 94 will be eluted and some species of fission products will remain in the column.

Saul Winstein's letter of July 14 was a disappointment to me because of the news that he will not be joining my group here. In my reply today, I took issue with his contention that he is not indispensable to our work by saying, "There is not a single man in the country who is indispensable to the war effort, in the true meaning of the word (unless it be Franklin D. Roosevelt); but I would be willing to say that you are more indispensable to our work here than are about 95% of the scientists in their war work." I closed by saying that Helen and I are enjoying Chicago much more than we had expected.

8/7/42

Garner has written to me twice in the last two weeks or so about his and Bonner's work on ores; so today I told him by letter that I will draw up a report on their investigations as soon as time permits. I expressed the opinion that the evidence for the presence of 94^{239} in carnotite is very good and I agreed with him that Connick will be a good man for continuance of the work after he drops it.

I wrote, "In discussions on our experiments on the presence of 94^{239} in pitchblende, Professor Fermi has raised the question as to whether the alpha particles might be due to elements 93 or 95 rather than 94^{239} . Of course, this question could only be settled by working with larger amounts of ore. However, I agree with you and the group there that the primary objective in this work from a wartime point of view is to ascertain the neutron-induced fission rate per unit weight of the ores, and therefore that the idea of adding 50-year 94 tracer in the experiments from now on is a good one.

"We have found your work on the oxidation potentials extremely interesting," I went on to say, "and this work is contributing heavily to our program here. We haven't enough time to do fundamental experiments of this sort and are depending upon you for this sort of information from now on. We will soon make a choice of oxidation agents for use in our experimental extraction plant here, and therefore it will be important to have data on concentrations, temperature and rate of oxidation."

"Search for Spontaneous Fission in U^{234} " by John Gofman and me was issued today in the form of a Chicago report, Report CF-220. The gist of the paper is that the half-life for spontaneous fission of U^{234} is greater than 10^{13} years. In performing the experiment, Gofman used a 0.4 microgram sample of U^{234} that Fontana and co-workers isolated from uranyl nitrate hexahydrate. In this method the UX_1 is removed from the major portion of UNH by ether extraction of the uranium and then precipitated as the fluoride from the aqueous phase with rare-earth carrier material, after which the UX_1 is separated from the major portion of the rare earths by a modified ceric iodate precipitation method. After the major portion of the UX_1 has decayed to U^{234} , the UX_1 that has not decayed is separated, together with rare earth fluoride, and the U^{234} is finally deposited onto platinum in a thin layer by electrolysis.

8/7/42.

Gofman placed the sample of U^{234} in a cadmium-shielded ionization chamber and used a linear amplifier system to count the fission impulses. Every 24 hours the sample was replaced by an ordinary uranium sample to demonstrate that the fissions induced in the ordinary uranium by a neutron source were being recorded with the proper efficiency. The 0.4 microgram sample of U^{234} was counted in this apparatus for a total of 420 hours, but not a single spontaneous fission count was observed. With an overall efficiency of 78%, this period corresponds to an effective counting interval of 328 hours. For a half-life of 3×10^{13} years, the expected number of counts is 0.9. Thus, we can claim that with a certainty of 0.41, the half-life for spontaneous fission of U^{234} is even longer than 3×10^{13} years.

From the European front comes simultaneously news both heartening and discouraging. The Russians reported capture of an "advantageous defense line" on the Don River near Stalingrad but at the same time had to withdraw their troops in the Caucasus to more eastern defense positions.

Saturday, August 8, 1942

Kohman, Turk, Jaffey and Koshland, who started work on the 300-plus pounds of Mallinckrodt purified UNH on Thursday, have now recrystallized it. All original bottles of UNH were selected on the basis of appearance, those having an orangish tinge being rejected. The recrystallized material was then replaced in the 12 glass jars and packed for shipment to the St. Louis cyclotron for neutron irradiation. The Port Hope UNH was set aside for possible future use, some of it in aqueous solution and some in the solid state; the attempts to purify it by ether extraction have been unsuccessful.

One of the problems encountered so far in the recrystallization process is when to stop "cooking." We have found that, if evaporation stops too soon, too much water is left in and the crystals come out wet, thus causing too much water phase for the next ether extraction. On the other hand, if evaporation continues too long, that is, if the amount of water left is less than the stoichiometric amount of $6H_2O$ per uranium

8/8/42

nitrate, then part of the uranium will come down as trihydrate, which will be difficult to dissolve in ether. This plaguing matter was cured, however, by performing a few simple experiments in the laboratory. Now the test for proper stoichiometry is to break up a small porcelain evaporating dish into fragments ranging in size from a dime to a nickel and toss them into the heated solution. The speed with which a chip falls in the solution decreases as the density increases. The concentration is just right when a chip at the surface takes about ten seconds to fall to the bottom.

Lawrence wrote to me. He thanked me for my letter of July 28 with its enclosures, which he said cleared up a mystery. Then he added, "I will put in a bid for the 3,000 microampere bombardment and I think the boys will handle it very soon."

The plan now is to helium-cool the chain-reacting pilot plant that is to be erected in the Argonne Forest Preserve. I met with the Engineering Council, along with Moore, Leverett, Steinbach, Fermi, Spedding, Wheeler, Wigner and Wilson, to discuss the steel shell that will surround the pile and contain the helium under pressure. Representatives of the Chicago Bridge and Iron Works say that two-inch thick steel will be required if the tank is cylindrical, but only 1-1/4 inch if composed of spherical elements. Wheeler suggested that the pile be designed big enough to take care of the effects of temperature and poisons on the reproduction factor k . Moore talked about having the safety rods inserted in the top so that gravity could be utilized and control rods inserted in the sides for convenience. Fermi thought that the capped-sphere design proposed by Wilson has certain advantages. He was concerned about neutrons activating the iron in the shell to produce the 47-day half-life activity (Fe^{59}) with its 1 Mev gamma ray. He would use as much dirt as possible for neutron shielding.

Depressing news from the Soviet front! Nazis have driven deeper into the Caucasus and are within 60 miles of the Maikop oil fields.

Sunday, August 9, 1942

Helen and I visited the Field Museum of Natural History near the Lake Michigan waterfront just south of downtown Chicago. We enjoyed in particular seeing the exhibits of American Indians of the Northwest.

Monday, August 10, 1942

Kohman, Jaffey and Koshland started work today on the 300 pounds of UNH that has been neutron-bombarded in the Washington University cyclotron at St. Louis. Five pounds of crystals were given to Fermi and Anderson last week to do some independent experiments. We also removed four pounds for use in the work of a number of members of my group on extraction procedures for 94.

Before the bulk of the 291 pounds that remain are worked on to extract element 94, it was thought discretionary to spend the next few days running a small sample through the proposed procedure. Consequently, four pounds of the irradiated UNH were dissolved in two liters of ether and shaken in a separator funnel. The somewhat milky water layer containing the 93 and 94 was removed, aerated, concentrated by evaporation and recrystallized. These crystals were treated with ether a second time and another milky water layer was obtained. This layer was set aside. Tomorrow the three of them will inquire into the distribution of the 94 (plus 93) in this second aqueous concentrate.

Cefola received a letter from Hamaker in Berkeley regarding micro-chemical equipment. Hamaker complained that without a priority number the orders will be slow in coming, and he asked Cefola to point out this situation to me. He also stated that Kirk of Biochemistry and Craig of Entomology have been hired by the project; they are working together full time on the new microchemical balance, designing an Emich balance from scratch.

A letter came to me from Ghiorso in Berkeley. He believes that he and Wilma will be able to leave for Chicago in about two weeks. He has

8/10/42

had a discussion with Stanley Abrams in regard to the special linear amplifier and offered, in order to save time, to start constructing at Berkeley a duplicate for us here at the Met Lab if that is my wish. He plans to see Friedlander in a day or so concerning the ionization chamber and the FP-54 electrometer outfit and will familiarize himself with these new circuits.

I wrote a letter to Fontana in Berkeley, proposing that he write up for submission as a report a complete description of his work on the preparation of U^{234} by the UX_1 extraction method, beginning with the ether extraction and carrying the process through to the final U^{234} electroplate, including a description of his method for combining samples. I suggested that his co-workers, Sheline and Prestwood, assist in the write-up and that I would have it turned out as a Chicago report.

"There is another industrial procedure," I wrote, "besides the ones that Joe Hamilton has been concerned with, from which concentrates with large amounts of UX_1 might be available. This is the procedure wherein U_3O_8 is treated with gaseous HF to convert it to UF_4 , and then, upon treatment with fluorine gas, the uranium is removed as UF_6 . The UX_1 presumably will remain in the non-volatile residue. I am sending you such a residue, which is the result of such a procedure by the Harshaw Chemical Company (Cleveland) on July 11. This residue amounts to 1% of the original crude U_3O_8 and contains as fluorides 28% Ni, 24% Cu, 15% Fe and 8% Mg. The remaining 24% of the impurities are distributed among a large number of elements. I thought you might determine the UX_1 specific activity of this material and give it consideration as a possible future source of UX_1 Perhaps you will call this industrial procedure to the attention of Dr. Hamilton and Professor Latimer (when Professor Latimer returns). I don't know yet how much U_3O_8 will be treated industrially in this manner."

The Battle of the Coral Sea in the Pacific has shoved the European War from the front page of the newspaper today. The United States is in its third day of attack on the Japanese-occupied Solomon Islands.

Tuesday, August 11, 1942

"Report for Week Ending August 8, 1942, Group C-V: Chemistry of 94" (No. CC-22) was submitted today. I report that Willard and Turk have done further work on the use of Hyflo Super Cel in the adsorption method for separating 94 and show that this adsorbent is able to separate 94 from at least 80% of fission products present in irradiated uranyl nitrate two weeks after an intermittent six weeks bombardment with neutrons. Cunningham, Cefola and Werner have continued the development of ultramicrochemical techniques by weighing microgram samples of sodium oxalate with a Salvioni-type balance and checking the weights by ultramicro titration with ceric sulfate. Brown and Hill have conducted experiments using a long-lived fission product sample (Berkeley Sample #1) to see where the fission product activities go using the fluorine method for separating 94. It is found that the main fraction of the activity is in two portions: (a) the water solution of the volatile products resulting from treatment of the UO_2 with anhydrous HF at red heat or (b) the residue resulting from the fluorination (and volatilization) of the uranium at $250^\circ C$ and the 94 at $500^\circ C$. Included is a summary of the work of Latimer's group— "Transference Experiments on 94 and 93" by Connick and Gofman, "Precipitation Reactions of 94 and 93" by Duffield, and "Oxidation Reactions of 94" by Garner.

Work continued on the second concentrate from the triethyl ether extraction process. The concentrate was centrifuged, and a clear yellow solution and a yellowish solid were obtained. The solution was decanted and the residue was suspended in water and recentrifuged twice. The first wash was yellow, and the second was clear. The solutions and washings were made up into 100 ml, of which 75 ml were given to James for the isolation of 93^{239} to be used in tracer experiments preparatory to a determination of the half-life of 94^{239} via the decay $93^{239} \xrightarrow{\beta^-} 94^{239}$. The remaining 25 ml was made up to 50 ml and designated AS. The residue was evaporated with HNO_3 and then with H_2SO_4 to fumes, treated with more HNO_3 , heated, diluted with H_2O and heated. Most of the solid dissolved with the original HNO_3 , giving a yellowish solution, but a good amount resisted all attempts to dissolve. The mixture was made to 50 ml and

8/11/42

labeled AR. Samples AS and AR were divided into aliquot parts, which are now being investigated as to the distribution of 93^{239} and 94^{239} .

Cunningham and Werner have had difficulty precipitating 50-year 94 tracer with lanthanum oxalate in the experiments they started early last week. They have decided to try thorium because it is much like 94 in its reduced state. Today they successfully precipitated 50-year 94 tracer with thorium oxalate from a solution about 0.1-0.2 N HCl.

Hamilton sent me a telegram from Berkeley to the effect that my uranium metal sample has received a deuteron bombardment of 5,000 microcurie-hours and asked if it should be cooled for two weeks before shipping to me. I was also informed that he has found 600 microcuries of UX_1 in the Mallinckrodt concentrate, or "mess" as he put it. I responded with another wire, asking that he ship the bombarded uranium by Railway Express on Saturday. I expressed my reaction to the news of the UX_1 yield by using an impromptu code, "Hurrah for you ex."

At the meeting of my group's Research Associates this evening we discussed my meeting with Charles Cooper and the obvious trend of our extraction work toward increasing practical cooperation with chemical engineers.

Battle is still raging in the Solomons. In Russia the Soviets are fighting with their backs to the Black Sea. It looks as though the Germans will succeed in taking over the devastated Maikop area.

Wednesday, August 12, 1942

On July 21 I wrote here that Brown and Hill have discovered that the higher fluoride(s) of element 94 can be completely volatilized in a fluorine stream of about 500°C . This volatilization takes place if the lower fluoride is prepared by the anhydrous ("dry") method. At that time they worked with a sample of uranyl nitrate to which 50-year 94 had been added. In an experiment today to confirm more fully the volatility

8/12/42

of the higher fluoride of 94, they worked with 0.8 gram of UF_4 that they prepared last week by hydrofluorination from the Berkeley neutron-bombarded UNH that we received from Wahl on July 20. This sample was fluorinated at $500^\circ C$, and all of the volatile material was collected in a cold trap. As they hoped and expected, all of the 94^{239} present in the original sample was found to have volatilized and condensed in the trap, together with the UF_6 formed.

Thus, they have shown that the higher fluoride of element 94 can be volatilized completely at about $500^\circ C$, this volatilization taking place if the lower fluoride is prepared by the anhydrous method. Uranium can be completely separated from element 94, as the very volatile UF_6 will be quantitatively formed at about $250^\circ-300^\circ C$, leaving the 94 behind. When the temperature is raised to $500^\circ C$, the 94 will volatilize quantitatively upon fluorination.

Covey's role in my department has been a "jack-of-all-trades." He assists the chemists in the laboratory whenever he can; he orders and receives equipment, acts as a carpenter and handyman, runs errands, scouts out and borrows apparatus and materials, takes unofficial photographs and makes himself generally useful. There is so much for him to do that I have hired a Laboratory Assistant to work with him. He is Roy C. Schroeder, a student from DePaul University and Wright University. Covey also has Walter Jilek and Wallace Vogwill with him as Laboratory Helpers. Jilek, Schroeder and Vogwill are also available to help the chemists in my group as needed. Covey and Schroeder, and Jilek and Vogwill to the extent they need it, have their headquarters in Room 411.

I am hopeful of having Stanley Thompson join my group, and we have had an exchange of several letters. His letter today was of especial interest because of the news from back home. He said that Standard Oil Company of California, at Richmond, for whom he works as a chemist, has increased its production of 100 octane gasoline by 40% and the company will be able to produce fuel of 110-120 octane if necessary. Also, a large toluene plant is under construction with a capacity of over 1,000,000 barrels per year, which can be converted after the war to produce aviation fuel. Standard Oil is having a C.I.O. scare, and wages

8/12/42

have been raised again as the El Segundo plant has been unionized. C.I.O. placards and papers are being distributed to the workers every day. Because of the manpower shortage, the chemical laboratory now has about 50 women operators, which is 20% of the total.

"I don't have to mention the shipyards to you," he went on, "but it is worth one's life to drive to work in the mornings. In fact the shipyard traffic should be a match for the German army. The propaganda is finally getting us to the point where we are almost believing that our war program is run with moderate efficiency and intelligence, although that excludes the synthetic rubber program."

Tonight at precisely 9:54 the air raid sirens will start warbling, so it has been announced, and 12,000,000 souls will be involved in a blackout that will extend over a wide section of the Middle West, centering on Chicago. The street lights and illuminated signs will be extinguished at 10:00, the elevated trains will stop; all cars are supposed to pull over to the side of the road and their headlights turned off; and all home lighting made invisible from outside. It is hoped that an inky pall will descend over the area for one-half hour. Civilian defense officials say that the object of the test is to see how effectively this area--industrially one of the most vital to the country--can make itself invisible to Axis bombers, should our foe be able to send airplanes so far inland.

It is now 10:15 p.m. and I can say that the blackout is not a success; an unacceptable amount of light is still shining.

Thursday, August 13, 1942

Experiments by Perlman and Knox the last few days show that thorium will precipitate from neutral or slightly acid solutions in the presence of ammonium ion upon the addition of peroxide. The principle of the procedure couples this property with the fact that uranium can be maintained in peroxide solutions through complex ion formation with various cations. Among these negative ions are fluoride, sulfate, acetate and tartrate. The addition of a salt such as ammonium fluoride would thus aid

8/13/42

the precipitation of thorium and at the same time prevent the precipitation of uranium. Fluoride was not tried because of the possibility of precipitating rare earth fission products. Ammonium acetate worked very well at pH 7, effecting a quantitative yield of 94 (>90%) but at this pH approximately 50% of the fission products came down with the thorium peroxide. This would naturally occur, since zirconium and rare earth peroxides are insoluble in neutral or alkaline solutions. When the pH was brought down to approximately 3, uranium precipitated, apparently due to the presence of free acetic acid and H_2O_2 .

The best results so far obtained were from $(NH_4)_2SO_4$ solution. The most unsatisfactory condition in this procedure is that precipitation must be carried out from very dilute uranyl nitrate solution. It was found that the concentration of uranyl nitrate hexahydrate must be less than 2%, otherwise thorium would not precipitate. Below this critical concentration the precipitation has in most cases been quantitative. The best solution is at pH = 2.8. This solution was heated for a few minutes, after which the thorium peroxide precipitated. Analysis showed that approximately 90% of the 94 could be isolated in this manner, indicating a practically quantitative precipitation. Less than 1% of the uranium came down with the thorium peroxide.

English and James have completed the separation of element 93 from uranium that was bombarded by deuterons in the Chicago cyclotron. They measured 4.58×10^7 disintegrations per minute of 93^{239} , which, for a total of 288 microampere-hours, gives 0.072 millicuries per 1,000 microampere-hours for the Chicago cyclotron. (Really 0.036, because about half the count comes from the conversion electrons of 93^{239} .) This is a very poor production of 93 indeed, compared with the 60 millicuries and 90 millicuries per 1,000 microampere-hours, respectively, for the St. Louis cyclotron and the Berkeley cyclotron. The amount of 94 to be expected, therefore, should be insignificant. Nevertheless, English and James will try to isolate 94 from the other half of the bombardment and will start their procedure in a day or so. The yield of 94, of course, will help us determine the isotopic assignment of the 50-year 94.

8/13/42

Latimer sent me a note saying that he is in Washington, D.C., for a couple of days and hopes to see me again when he returns to Chicago Friday or Saturday.

Harlan Baumbach, who works for Paramount Studios in Los Angeles, and I are still corresponding about the possibility of his coming to Chicago to join my group. He asked about living conditions in Chicago and I said, among other things, "The rents, to be sure, may be somewhat higher than in Los Angeles, but the food costs do not seem to be appreciably higher. Chicago is a very interesting city, and Helen and I are enjoying it much more than we had expected to. The travelling and moving expenses of you and Nathalie to Chicago and back to Los Angeles would be paid. The position would offer draft deferment, with a certainty, but we do not get tires. I am afraid that practically no one is getting the latter at present; gasoline, of course, is not being rationed in Chicago as yet. A number of the people in my group brought their cars to Chicago, and a number chose to leave them back home."

The regular Thursday evening meeting of the Research Associates was held, with Wollan and Wilson in charge. Wollan has been studying the diffusion of fission products from uranium metal into a cooling gas of helium, and he told us about experiments in progress to test various coatings on uranium plates to confine the fission products. Wilson, who heads up Physics Group V, is in charge of instrumentation for the Met Lab. The laboratory has on hand 52 scaling circuits, 52 stabilized power supplies, and 19 amplifiers for proportional counters and alpha and fission chambers. In his discussion of his group's activities, he told us about proposed controls for the first chain-reacting pile, which include control circuits, means of driving safety rods and regulating rods, detecting devices such as proportional counters and BF_3 chambers and an alarm system in case helium pressure is lost from the shell that will enclose the pile.

The battle in the Solomons continues for the seventh day.

Friday, August 14, 1942

Kohman, Jaffey and Koshland find that nearly all of the 94^{239} and 93^{239} is in the soluble fraction (AS) in their trial chemical separation from the four pounds of St. Louis neutron-bombarded UNH. They find an amount of 94^{239} corresponding to about 20,000,000 alpha disintegrations per minute in the total 300 pounds; assuming a half-life of 30,000 years for 94^{239} , this corresponds to a total of about 180 micrograms. They are now ready to start soon the extraction of 94^{239} from the bulk of the neutron-irradiated UNH.

Wahl wrote on Wednesday, saying he has written a rough draft of a report on the half-life of 94^{239} and would mail it the next day (yesterday). He, too, is complaining that they cannot get vital equipment because of the lack of priorities. At Mrs. Moquin's suggestion, he asked if I could procure for them four centrifuges, two Lauritsen electroscopes, two eight-inch fans, six Sunbeam hot plates and 50 square inches of two-mil platinum. He mentioned receiving the enlarged photograph we have made of the Berkeley isotope chart. "It is really beautifully done and large enough to be very useful. I had a hard time keeping it as Prof. Eastman was so envious when I showed it to him." He read about the fluorination experiments in our last week's report and commented that the fluorine method now looks to be the most promising method of separation proposed.

I received a telegram from Hamilton in Berkeley to the effect that the deuteron-bombarded uranium metal (about which he wired me earlier this week) is on its way and the other material (UX_1) is at the final stage of purification.

I also received an amusing letter from Kamen, dated yesterday, regarding our deuteron-bombarded uranium, which I will quote: "Because of the urgency of your telegram we are shipping the stuff today by Railway Express. We had to pack it in approximately a hundred pounds of lead to cut the activity down to a point where the tender susceptibilities of our stevedores would not be impaired. The sample is the result of 5,000

8/14/42

microampere-hours of bombardment which was finished on the 8th. It should be in your hands in a few days. The lead container is composed of nine octagonal pieces of lead of a beauty which is indescribable and we would like to have them back as they make a convenient box for our particular disc-shaped targets. Hoping this letter finds you and after finding you discovers you in good health, and regards to Helen and all."

Latimer was in town today and had lunch with Helen and me in our apartment. We had a thorough discussion of the status of the work of our groups at Chicago and Berkeley.

Saturday, August 15, 1942

With the objective of isolating 94 as a pure compound, Cunningham and Werner commenced work on a Berkeley sample of 94^{239} (part of the neutron-bombarded UNH received by us from Wahl on July 20). They started with a 15-milliliter solution containing 5 mg Ce^{+4} , 5 mg La^{+3} and 2-1/2 ml of 6 N H_2SO_4 . Presumably, it also contains close to one microgram of 94^{239} . After partial evaporation, the 94 and rare earths present were precipitated as fluorides and the precipitate was dissolved in a few drops of sulfuric acid and the solution was evaporated to a volume of about one milliliter. The supernatant liquid was found to contain essentially no alpha particle activity. Further work on the precipitate will be continued Monday.

A report, "The Present Status of Fluorine Production," by Harrison S. Brown, was issued today. Earlier this month Brown visited several installations where fluorine cells are being used in production. His report covers the du Pont's two cells, the Harshaw cell, Johns Hopkins' three cells and Columbia's two cells. He also went to the Hooker plant in Niagara Falls to see the large Hooker type "S" cell used extensively for the production of chlorine. The objective of his visits is to prepare for the eventual design and construction of fluorine generators to be used in the chemical separation of 94.

8/15/42

It is appropriate here for me to give an accounting of experiments on the distribution of long-lived fission products that were conducted by Brown and Hill during the time since they first got a sample of the irradiated UNH on July 20. The advantage of using this particular sample is that it should closely approximate the fission condition of the material from an operating chain-reacting pile one month after shutdown. The beta particle and gamma ray activity losses on performing each of the following five steps between July 20 and July 31 were determined:

- (1) Convert UNH to U_3O_8
$$UO_2(NO_3)2 \cdot 6H_2O \xrightarrow{700^\circ C} U_3O_8$$
- (2) Convert to UO_2 with H_2
$$U_3O_8 + 2H_2 \xrightarrow{600^\circ C} 3UO_2 + 2H_2O$$
- (3) Treat with HF (anhydrous)
$$UO_2 + 4HF \xrightarrow{600^\circ C} UF_4 + 2H_2O$$
- (4) Remove uranium with F_2
$$UF_4 + F_2 \xrightarrow{300^\circ C} UF_6$$
- (5) Remove 94 with F_2 , i.e., volatilization of the higher fluoride of 94 at $600^\circ C$

(1) The loss in fission product activity in step (1) was found to be less than 1%, thus indicating that the activity contributions of krypton and xenon are quite small.

(2) A small but detectable loss in activity of about 1% was found in step (2). This is probably due to the iodine and bromine volatilization as HI and HBr.

(3) A marked decrease of both beta and gamma activity was observed on treatment with anhydrous HF. The gamma ray activity loss as measured through 11.5 grams of lead was about 25-30%. The beta particle activity losses were about 36% using absorbers from 7.3 to 117 mg/cm². The elements that volatilize are probably columbium, zirconium, antimony and possibly 43 and tellurium.

(4) On fluorinating the UF_4 formed in step (3) at $300^\circ C$ the uranium

8/15/42

volatilized away completely. No detectable amount (<1%) of the beta particle activity, however, passed over with it.

(5) On raising the temperature to 600° and refluorinating the reaction vessel, no detectable loss of beta particle activity was observed. It should be noted that this is the step in which one would volatilize element 94.

The residue contained the balance of the beta particle activity (about 60%) and the gamma ray activity (about 70%). This residue consists of rubidium, strontium, yttrium, barium, lanthanum, cerium and cesium.

The same series of runs was made again (ending this week) on another portion of the Berkeley sample. It was found that in the hydrofluorination step (3) the amount of volatilization of beta particle activity decreased to about 15% of the total, but that the volatilization of the gamma ray activity increased to about 60-70% of the total. In all other steps the beta and gamma activity losses were less than 1%.

The Navy announces it is making satisfactory gains in the Solomons, but news from the Russian front remains bleak as the Germans broke through the Soviet lines in two places.

Sunday, August 16, 1942

Helen and I visited the aquarium and planetarium, located on Lake Michigan. Later we went for a long walk along the shoreline.

Monday, August 17, 1942

The ether extraction of the bulk of the 300-pound shipment of neutron-irradiated uranyl nitrate hexahydrate started today in earnest. Jaffey, Kohman, Koshland and Turk, plus two research assistants borrowed from Coryell's group, Donald W. Engelkemeir and George W. Campbell, Jr., were assembled in the attic laboratory to start the tedious and lengthy procedure.

8/17/42

Because of the huge amount of UNH to contend with, eight two-liter and three-liter separatory funnels were employed. In this operation, about 90% of the original uranium will go into the ether phase and 10% will go into the water phase, the latter phase including all of elements 93 and 94 and essentially all of the fission products. Hence about 30 pounds of UNH should be expected to crystallize out of the water phase from this first ether concentration. A subsequent ether extraction will reduce the 30 pounds to three pounds, at which time the isolation procedure can be continued on the laboratory bench. Each time, of course, all the original 93 and 94 go into the much smaller water phase, destined for ultimate isolation of 94 in the pure form.

The six men, working in the big attic room and adjoining roof area, were attired in lab coats and rubber gloves. Nearby were some opened boxes of the neutron-bombarded UNH crystals that had been shipped from St. Louis. The person making the separation would scoop up some crystals and place them into a separatory funnel. The funnel was then filled with ether and additional crystals would be added until no more would dissolve. He would stand on one side of a lead shield resting on a table and grasp the funnel in both hands on the other side. In this way he was protected somewhat from body exposure to the radiation. One hand was at the stopcock, with fingers braced to keep it from falling out; the other hand was at the top, with fingers on the glass stopper to keep it from popping out. He would shake the funnel vigorously for awhile and then set it aside to wait until the two phases separated. After the water layer had clearly separated from the ether layer that floated above it, he would extract the water layer (containing all the 94 and 10% of the uranium) through the stopcock and divert the ether layer to storage in one of the empty carboys. We don't know yet if we will attempt to recover the uranium nitrate from these ether layers. They are very dark in color, due to dirt and other impurities.

Upon opening some of the boxes of crystals it was found that the material was caked. So while the ether extraction was in progress, a screening of almost all the UNH was carried on. From the radiological point of view, I think the screening operation could be the most dangerous of all. The amount of dust was slight, and no one was wearing a mask; nevertheless, there was the potential danger of inhaling radioactive dust.

8/17/42

In this manner, four batches of approximately 115 pounds of raw UNH were sieved and ether-extracted today. That portion of the UNH that did not pass through the screen was mixed with a little water and poured into a large dish to heat overnight on the steam table.

The determination of the volatility of the higher fluoride of element 93 is of considerable interest, not only from the point of view of knowing its involvement in fluorine treatment of pile uranium, but for the purpose of correlating the chemical properties of elements 92, 93 and 94. Brown and Hill began their experiments this week by doing just this—investigating the volatility of the higher fluoride of element 93.

To a solution containing 105 mg of unirradiated UNH, they added about 10,000 beta-counts (counted through a 7.56 mg/cm^2 absorber) of 2.3 day ${}_{93}^{239}$. This was ignited to U_3O_8 and then converted to UO_2 by hydrogenation.

Small samples of this were weighed into smaller copper discs and converted to UF_4 by hydrofluorination (treatment with anhydrous HF). No loss of 93 was observed in this step. The UF_4 samples were then fluorinated at $250^\circ\text{--}300^\circ\text{C}$ for half an hour. In all cases, the 93 volatilized with the uranium. This indicates that the higher fluoride of element 93 is more volatile than that of element 94. Its behavior thus resembles more closely that of uranium.

After many attempts, Cunningham and Werner finally succeeded today in making a weighing calibration test of the Salvioni balance using microgram quantities of thorium oxide. They proceeded as follows: From a standard solution of thorium nitrate, known quantities of thorium were measured out and precipitated as the hydroxide. The washed hydroxide was dissolved in a little HNO_3 , transferred to a platinum weighing boat, and ignited to the oxide, which was weighed on the ultramicrobalance. The quantity of ThO_2 , calculated from the known volume of standard solution, was 2.92 micrograms. The quantity found by weighing was 2.94 micrograms. This demonstrates to our satisfaction that the precipitation, washing, ignition and weighing techniques now being employed are reliable for quantitative work.

8/17/42

Cunningham and Werner also continued their work on isolating 94 from the Berkeley sample. After repeated oxidations (with $K_2S_2O_8$ and Ag^+) they succeeded in precipitating the bulk of rare earths as fluorides, leaving the oxidized 94 in several supernatant solutions, which were then combined and concentrated by evaporation to the point where SO_3 fumes were evolved. To this was added 0.5 mg Ce^{+3} and 0.5 mg La^{+3} . Next, HF was added to precipitate the reduced form of the 94 along with the cerium and lanthanum fluoride carriers. The precipitate was fumed with H_2SO_4 to eliminate fluoride, dissolved in water, the solution oxidized with peroxydisulfate plus silver ion, and the rare-earth carriers precipitated away from the 94 as fluorides; then the 94 was reduced by heating until SO_3 fumes were evolved and co-precipitated with 20 micrograms of La^{+3} as the fluoride. The fluoride precipitate was transferred to a small shallow platinum dish and the fluoride expelled by heating with H_2SO_4 . Some spattering occurred during this process. The 94 was again oxidized with peroxydisulfate plus silver ion, the lanthanum removed as the fluoride and the silver as silver chloride. The resultant product supernatant contains approximately 57,000 counts of alpha activity per minute (presumably due to 94^{239}) and was placed on a steam bath to concentrate. More work will be done on the concentrate tomorrow.

The deuteron-bombarded sample of uranium arrived from Berkeley in the afternoon. It was packed in a hundred-pound cask of lead and was really hot, having had a 5,000 microampere-hour bombardment.

In a continuation of the work begun last Thursday, English and James completed the chemical isolation procedure for 94 from the uranium that received a deuteron bombardment in the Chicago cyclotron; and, to no one's surprise, they were unable to discern any counts that could be attributed to the 50-year 94. This result is strong evidence that this isotope of 94 is formed in the Berkeley and St. Louis cyclotrons by the $d,2n$ reaction of U^{238} and is, without much doubt, 94^{238} . They will now isolate the 94^{238} from the Berkeley deuteron-bombarded uranium.

8/17/42

The Soviets announced the fall of Maikop but said that they had rendered the oil establishment completely unusable. Meanwhile, the United States Marines are fighting on in the Solomons.

Tuesday, August 18, 1942

The six attic chemists continued with their ether extractions. The non-screenable batch that had heated overnight was taken to the roof, mixed with water and evaporated so that it would recrystallize. These crystals were again screened, which required some lumps to be ground up first. By the end of the day, five batches of neutron-irradiated UNH—the remainder of the 291 pounds—were put through the extraction process. All the aqueous extracts were cloudy, and toward the end, as the dirtier, drier and recrystallized materials were used, the extracts were quite milky. Each time, the ether phase was washed with two 15-20 ml portions of water to completely recover the active products. Then the ether phase, which contained large amounts of insoluble dirt, was removed and was set aside. Even material blown out of the stopcocks was saved; all such residues were combined into a separatory funnel for an ether extraction. The combined water layers collected today were poured into four jars, which will be aerated during the whole night. Tomorrow, the concentrates will be evaporated and crystallized.

Cunningham and Werner transferred the Berkeley concentrate to a platinum dish for further concentration. When they saw that it was creeping over the sides, they transferred it to a larger dish. Unfortunately, the dish contained some lanthanum and it was necessary to perform another oxidation and fluoride cycle.

Brown and Hill had a more successful day. As a check on the results of the experiment they performed yesterday, they took about 15 mg of the UO_2 containing 93 tracer and fluorinated it at $250^{\circ}C$ for a half hour, meanwhile collecting the volatile products in a trap maintained at dry ice-acetone temperature. The volatile products were then dissolved in water, and the 93 was extracted, after reduction, by co-precipitation with

8/18/42

LaF₃ carrier. It was found that all of the 93 that had volatilized had collected in the trap.

Perlman and Knox, working on the thorium peroxide precipitation method, find that fission products can be effectively held in solution by the addition of small amounts of zirconium, lanthanum and cerium. When this is done, less than one percent of the fission activity appears in the washed thorium peroxide. If the hold-back carriers are not added, then 9-12 percent of the fission beta particle activity and a larger amount of the gamma ray activity comes down with the thorium.

At the meeting of my group's Research Associates this evening, there was much discussion of our large ether extraction effort on the neutron-irradiated UNH from St. Louis and how to keep the radiation exposure down—this in addition to the usual review of work in progress and plans for the future.

Today's newspaper carries the story of the defeat of the Japanese fleet.

Wednesday, August 19, 1942

Aeration of the concentrates in the four jars was discontinued this morning. The concentrates were combined and mixed together thoroughly. We have decided from now on "not to put all our eggs in one basket." The mixed solution was poured back into the four jars in roughly equal portions. The average net weight of each solution was 13 lbs., 5 oz. The next step will be to recrystallize all the UNH out of the aqueous solutions, and this was commenced today.

Cunningham and Werner were back at work this morning with their Berkeley concentrate. The concentrated solution obtained by evaporation contained much K₂SO₄ (reduction product of K₂S₂O₈) and Ag⁺. It was diluted and the silver precipitated as the chloride. About five micrograms of La⁺³ were added and the 94 and lanthanum were precipitated

8/19/42

as the hydroxide. The hydroxides were dissolved in a little HNO_3 , the 94 was oxidized and the lanthanum was precipitated out as the fluoride. Tomorrow they hope to precipitate the pure 94 as a fluoride, the end product.

Albert Ghiorso is finally with us as a team member. It has been six weeks since we first started negotiating. I am happy that he joined us as a Research Associate; he will be able to play a key role planning and building in our electronics and counter program. He will make his headquarters in Room 402 with English and Jarrett. Helen is helping Wilma get settled and showing her the sights of Chicago.

The news from the Soviet Union today is still bad. The Soviets have fallen back in two sectors at Stalingrad.

Thursday, August 20, 1942

Perhaps today was the most exciting and thrilling day I have experienced since coming to the Met Lab. Our microchemists isolated pure element 94 for the first time! This morning Cunningham and Werner set about fuming (with evolution of SO_3) yesterday's 94 solution containing about one microgram of 94^{239} , added hydrofluoric acid whereupon the reduced 94 precipitated as the fluoride, or perhaps a double fluoride, free of carrier material, from a total solution volume of 15λ .

This precipitate of 94, which was viewed under the microscope and which was also visible to the naked eye, did not differ visibly from the rare-earth fluorides. (Shortly after the 94 was precipitated, a considerable amount of K_2SiF_6 was observed to separate, as a result of the fact that precipitation had been performed in glass vessels. This will be avoidable in future work because we have now developed suitable fluoride-resistant micro vessels.)

From the alpha-activity remaining in the supernatant liquid after the final precipitation as a fluoride, it can be calculated, using 30,000 years as the half-life of 94^{239} , that this salt of 94 has a solubility of

8/20/42

the order of magnitude of 10 mg of the element per liter of 6 N HF solution. This value is necessarily somewhat tentative.

It is the first time that element 94 (or any synthetic element, for that matter) has been beheld by the eye of man. I'm sure my feelings were akin to those of a new father who has been engrossed in the development of his offspring since conception. Counting from the time that uranium oxide was first bombarded by deuterons on December 14, 1940, to produce the 50-year 94 isotope, the gestation period has been 20 months. Not everyone shares Fermi's confidence that the pile will chain-react and produce 94. Without a working pile, we will never be able to produce 94 in much greater yields than with the cyclotron, and it would probably remain a novelty for years to come. Without the pile, the dream of atomic power plants will come to naught. And without 94, the only possibility of producing a bomb will be to use an isotope of uranium.

By afternoon a holiday spirit prevailed in our group. Covey brought in photo floodlamps and his 35mm camera and photographed everything in sight (Figures 9, 10, 11 and 12). By this time the precipitated 94 fluoride had taken on a pinkish hue. Perlman, Cefola and I, and many others, including Kohman, Jaffey and their helpers, who were working in the attic laboratory on the extraction of 94^{239} from neutron-bombarded UNH, came into Room 405 to peer through the microscope at the tiny speck.

All this while, Kohman, Jaffey and their assistants were recrystallizing the UNH from the first ether extraction, which they have been doing for the last two days. In this step, the four separate solutions were taken to the roof and transferred into 14-inch evaporating dishes, set over hot plates, and heated to almost boiling. Each concentrate was kept simmering; and, as it thickened from evaporation, it was vigorously stirred. When it was evident that there remained a ratio of $6\text{H}_2\text{O}$ to one uranium nitrate by the porcelain chip test, the heating was stopped. Stirring continued, however, until the mass cooled down and hexahydrate crystals appeared. Each dish was weighed before and after emptying. The total net weight of the reconstituted UNH crystals containing the 93 and 94 is 31 lb., 10.5 oz.

8/20/42

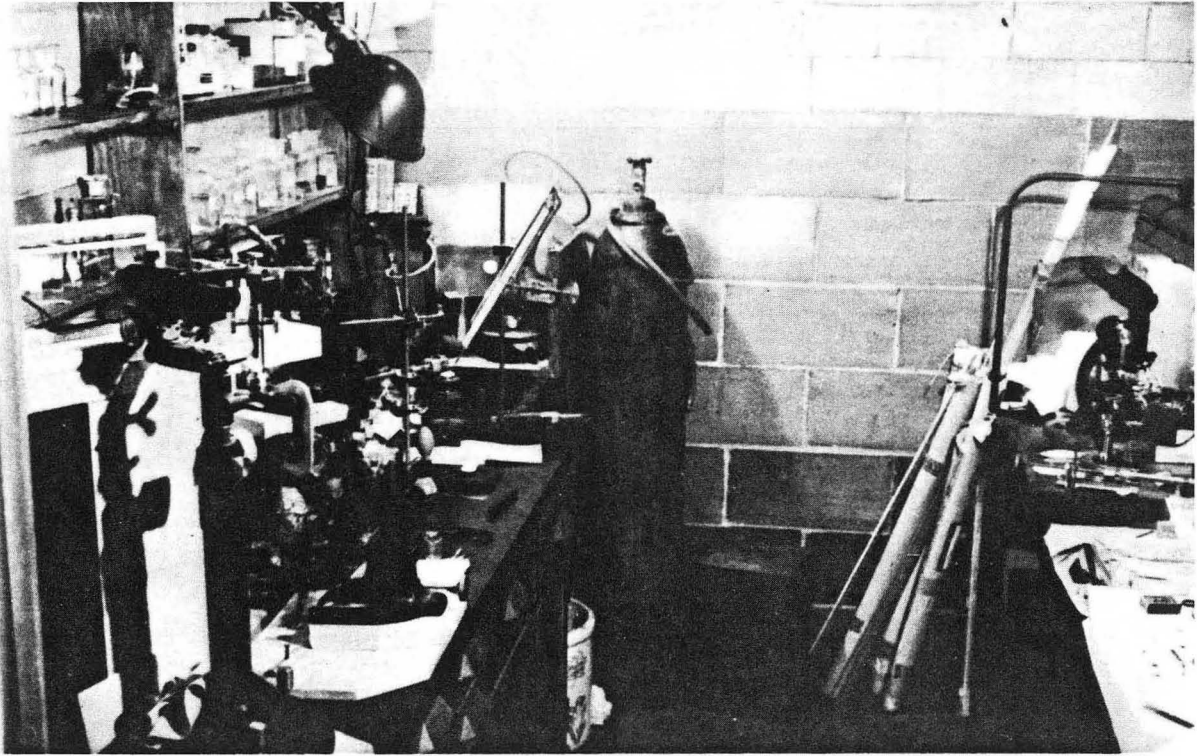
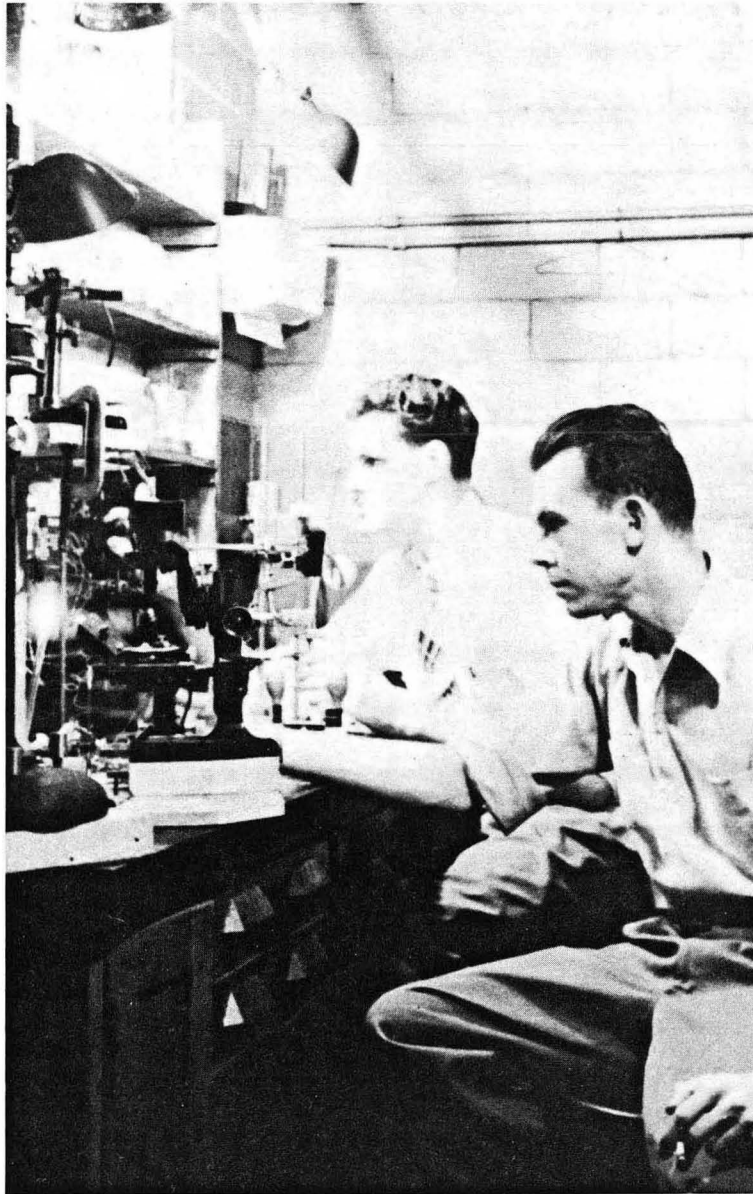

Fig. 9 Room 405, Jones Laboratory, August 20, 1942. (XBB 768-7455)

8/20/42



*Fig. 10 L. B. Werner and B. B. Cunningham,
Room 405, Jones Laboratory, August
20, 1942. (XBB 768-7456)*

8/20/42

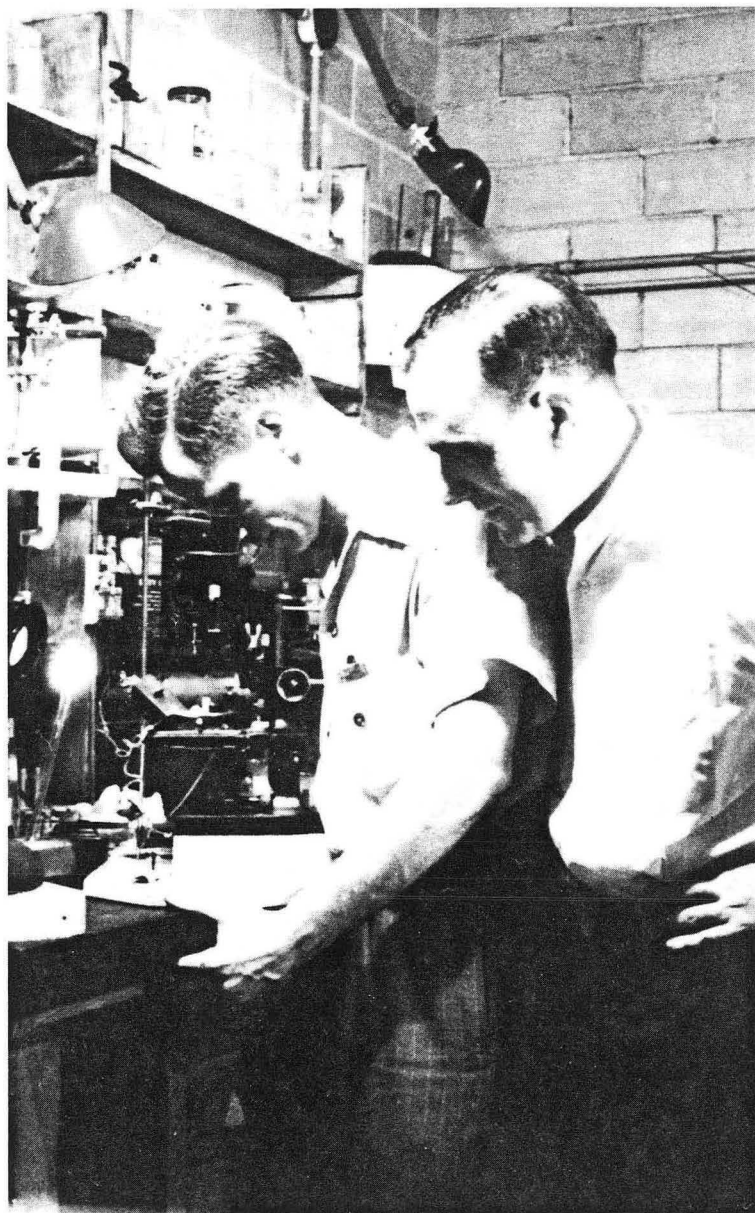

*Fig. 11 I. Perlman and M. Cefola, Room 405,
Jones Laboratory, August 20, 1942.
(XBB 768-7457)*

8/20/42



Fig. 12 G. T. Seaborg, Room 405, Jones Laboratory, August 20, 1942. (XBB 768-7458)

8/20/42

This afternoon we started the second ether concentration of these crystals. By the time it is completed we should have, in the four aqueous phases, a total of approximately three pounds of UNH out of the original 291 pounds.

I have asked Perlman, Goldschmidt, Hill, James and Knox to relieve some of the men for the time being, as I don't think it wise to expose any one person to too much radiation, especially since we don't have any good equipment for measuring the amount of exposure. The lead shield was disposed of because it proved too awkward and tiring to hold and shake those large separatory funnels at arm's length. As a radiological control, we rely entirely on Dr. James Nickson, the medical doctor in charge of health problems of Met Lab employees. Every day, the men who are working on the extraction line up, and a pretty technician takes blood samples. If she should find that the concentration of white blood cells has dropped or the cells have changed shape, then we will have a good indication of overexposure to radiation. I should note, however, that blood counts have been discontinued at Berkeley because no correlation with cyclotron exposure has been observed. So far, everyone appears healthy and normal, and I will therefore use the men on a rotating basis. Kohman and Jaffey need special attention because they are involved one way or another almost every day.

I wrote Baumbach saying I have learned he has written Moulton saying he will join me at the Met Lab if a leave of absence can be arranged for him; I said we will exert great efforts to arrange this.

In the evening I attended the Thursday evening meeting of Research Associates and felt like passing out cigars. I think my announcement of the first isolation of a carrier-free 94 compound was like a catalyst to those present. Wigner, Fermi and Allison were in charge of the program, but for awhile the attention of all the people there was centered on the work of my group. The fact that there is now visible evidence of 94 made all of them, I am sure, more confident of their own contributions at the Met Lab. Without exception, all of them are here to either produce 94 or

8/20/42

to work with it directly or indirectly. In response to Teller's question as to the identity of the 94 compound, I was evasive due to the extra secrecy (i.e., compartmentalization of information) surrounding the chemistry of this element.

In today's newspapers heavy losses on both sides were reported at Dieppe on the coast of France after Americans, Canadians, British and Free French assaulted the coast. Allied objectives were, however, achieved.

Friday, August 21, 1942

Cunningham and Werner continued their work on the 1 microgram of 94 which they precipitated in carrier-free form as the fluoride yesterday, with the aim of converting the 94 to iodate in carrier-free form. The mixed precipitate of 94 fluoride and K_2SiF_6 was treated with H_2SO_4 and heated to the appearance of fumes of SO_3 . Because of the large volume of water required to dissolve the residue, 20 micrograms of La^{+3} were added as carrier and mixed $La(OH)_3$ and 94 hydroxide were precipitated. This was dissolved in a minimum volume of 6 N H_2SO_4 . In this operation some of the La^{+3} as $La_2(SO_4)_3$ failed to dissolve, and this was centrifuged off. Excess potassium iodate was added to the filtrate and mixed iodates of 94 and Ag^+ (the silver coming from traces of silver oxide which had precipitated with the hydroxides) were obtained.

The work with the second ether extraction is still going on. At times since starting the purification of the Port Hope UNH, there might have been as many as six or eight men working together, such as shaking up the ether solutions, pouring off the layers, stirring solutions in the evaporating pans, opening fresh boxes of crystals, and shaking the screens. The whole operation has been carried out in a spirit of boisterous fun, with considerable kidding and joshing. The men not only work as a team but behave as though they are a close-knit family. Most of the men are single, under 30; many of them eat together and continue their friendships off the job.

8/21/42

A few members of the group working on the neutron-irradiated UNH ether extraction process are careless about wearing gloves, although I have admonished them from time to time about their need to observe radioactive safeguards. One of these persons is Goldschmidt, whom I would expect to be the most careful of all, but he tells me that he and the other chemists at the Curie Lab in Paris were rather negligent in protecting themselves from radioactive contaminants. Since we have no instrument for counting radioactivity of the hands to see if they are contaminated, Goldschmidt volunteered to contribute a piece of skin from his own hand, which came from a blister. Because of its appearance it was promptly dubbed "pig's skin." Sure enough, when it was placed in the counter it proved to be quite active. We intend to follow its radioactive decay in the days to come.

Fermi came to me with a request for a list of fission chains. He has just been in a meeting with Cantril, Moore, Steinbach and Whitaker, the purpose of which was to initiate discussions on the problem of handling radioactive gases that will be present in both the experimental pile and the pilot-plant pile. At the meeting, Fermi had given his estimate that there might be 10^5 curies of activity in the experimental pile in gaseous form. He pointed out that the dangers involved in handling this material essentially are of two different kinds—general radiation dangers and dangers due to the inhalation of these radioactive gases. He said he has some figures on the various fission chains that are known at the present time and said that he would like me to give him an up-to-date list of these chains for the use of people involved in these situations. In the case of the experimental pile, he told the others that he believes the only dangerous gaseous substance will be the five-day xenon. Dr. Cantril expressed the opinion, on being questioned by Fermi, that the time necessary for recovery from radiation exposure has a minimum value of about four weeks and a maximum value that could be greater than one year. He also stated as a tentative value that general body radiation of one roentgen per day could not be permitted over as much as one month's time. He seemed to prefer to keep this down fairly close to 0.1 r per day, or to 3 r per month. It was agreed by all present that if they design the plant

8/21/42

assuming that the active gas liberated has the radiation properties of radon gas, then we shall have a considerable margin of safety.

I received a letter from James T. Grady, the managing editor of the American Chemical Society News Service, asking for a paper or abstract of my talk "Review of Artificial Radioactive Isotopes Useful as Tracers" that I am to present before the Division of Physical and Inorganic Chemistry at the meeting of the American Chemical Society in Buffalo in September.

During the last week we have ordered over \$3,000 worth of equipment and supplies for our new chemistry building. Although we have the highest purchasing priority, it is often the case that the supplier is out of stock or the manufacturer is now producing war material. Since we don't want to be caught short when we move into the new chemistry building, it behooves us to look ahead. Ground-breaking for construction of the new building is scheduled to start tomorrow. The present plan is for Spedding's and my groups to occupy it as the building progresses. The entire building will be one story high and cover a rectangular area approximately 100 feet by 300 feet and will be located on grounds formerly used as tennis courts. It will face west along Ingleside Avenue from 56th Street on the north to half-way to 57th Street on the south. We will be surrounded by apartment buildings but will not be too far from the center of the campus.

Saturday, August 22, 1942

Today, Kohman and Jaffey proudly showed me four batches of murky yellow water. They contain our precious 94 and represent the aqueous phases from the second ether extraction of the 300 pounds of St. Louis neutron-bombarded uranyl nitrate hexahydrate. Each batch is about 600 ml in volume and will be worked on individually to extract the 94²³⁹. Perlman, Kohman, Jaffey and Goldschmidt will each take a batch, numbers 1, 2, 3 and 4 respectively. I have decided to divide the final isolation procedure in four batches in this manner in order to have insurance against major

8/22/42

losses due to unavoidable accidents during the somewhat difficult procedures that must now be carried out on these highly radioactive fractions. Each of the four will use our well-established oxidation-reduction procedure using rare-earth fluoride as carrier for 94 and will reduce the volume and amount of carrier in successive oxidation-reduction cycles. Much of this work will take place in Room 401 which has two fine fume hoods.

In this second ether extraction, which took place over the last two days, each of the four fractions of crystallized UNH was separately extracted with ether in the usual manner, except that the ether layer was washed with portions of water totalling 100 ml, more or less. The combined water extracts of each separate fraction was aerated overnight in a one-liter Erlenmeyer flask. So today we have the results of the last two weeks' work—four flasks of yellow water containing uranium, fission products and elements 93 and 94.

Continuing their work on the isolation of pure 94 iodate, Cunningham and Werner dissolved the silver iodate away from their impure 94 iodate precipitate by using 6 N NH_4OH , which was subsequently removed. A small amount of brownish crystalline precipitate remained, which may contain some cerium impurity.

In an experiment today, Knox continued his and Perlman's investigation of thorium as a carrier for 94. Yesterday he performed an experiment to determine how quantitatively 94 will follow thorium in precipitation as the peroxide from $(\text{NH}_4)_2\text{SO}_4$, $\text{UN}\cdot 6\text{H}_2\text{O}$ solutions with the hold-back carriers, zirconium, lanthanum and cerium, present to prevent the precipitation of fission product radioactivity. He found that some of the thorium and 94 were left behind, which he attributed to the fact that insufficient peroxide was used. In today's experiments he increased and varied the amount of H_2O_2 and concludes that the higher concentration of peroxide the more the thorium and 94 will come down quantitatively.

Perlman and Goldschmidt, in addition to their involvement in the ether extraction of the St. Louis UNH, are busy with their experimental survey of long-lived fission products. They are working with samples from

8/22/42

neutron-bombarded UNH from both the Berkeley and St. Louis cyclotrons. The former sample, of course, had a 40,000 microampere-hour bombardment of neutrons from 16 Mev deuterons-on-beryllium from April 24 to June 20, 1942, and the latter a 50,000 microampere-hour bombardment of neutrons from 12 Mev deuterons-on-beryllium from June 10 to July 20.

After replying to Grady's letter and sending him an abstract of my upcoming Buffalo talk, I wrote a letter to my friend, Stan Thompson, saying that an offer of a position with us is being sent to him through official channels. Coming from industry (The Standard Oil Company), his surprisingly high salary rating created somewhat of a problem in our personnel office because it is even higher than the starting salary of some Ph.D.'s. If he accepts, he will be the highest paid A.B. man on the project. Knowing Stan and his immense capacity for good work, I think he will be worth every penny to the project as a whole. "I believe you and Alice will enjoy Chicago very much," I wrote. "Helen and I are finding it a very interesting place. We have not frequented any of the places that have hot colored bands (which Stan is keen to hear), but we have spent an evening in the Empire Room of the Palmer House and one in the Marine Room of the Edgewater Beach Hotel. The museums here also are very interesting; although I wouldn't have classed myself as a museum enthusiast, I must admit that I have enjoyed visiting the Field Museum of Natural History and the Museum of Science and Industry several times."

Construction started today on our new chemistry building.

Monday, August 24, 1942

Cunningham and Werner continued their program to prepare some pure 94 iodate. In order to remove the ceric iodate impurity, they treated their precipitate with a little H_2O_2 in approximately 3 N HNO_3 and 1/4-saturated KIO_3 . The color of the precipitate changed to white without any other visible change in its characteristics. This remaining precipitate presumably is the iodate of pure element 94. From the alpha-activity remaining in the supernatant liquid in equilibrium with the 94

8/24/42

iodate, it appears that 94 iodate in 1/4-saturated KIO_3 solution in approximately 3 N HNO_3 has a solubility of the same order of magnitude as the fluoride or somewhat less (approximately 10 mg per liter). This value also is a tentative one.

Brown and Hill started a series of experiments today to compare the volatilization of uranium and 94 fluorides as a function of temperature. In their first run they had difficulty in transferring volatilized 94 fluoride to a cold trap with UF_6 ; a substantial fraction of 94 was retained in the outlet tube of the fluorination reactor. They hope to complete these studies in about a week.

In addition to the pictures he took last Thursday, Covey has taken a couple of pictures of Room 404 and some of its occupants (Figures 13 and 14).

The Cunningham baby, Susan, was born today.

Helen and I had dinner with Latimer at the Blackhawk Restaurant (Randolph and Wabash Streets). He plans to return to Berkeley next Monday and then come back to the East. As usual, I brought him up to date on the work at the Met Lab and our collaboration with the Berkeley group.

More bad news from the Russian front! The Germans are driving closer to Stalingrad.

Tuesday, August 25, 1942

I have never seen Perlman more upset and disturbed than he was today. When he came to the attic this morning to work with his batch (one of the four) of water layer from the ether extraction, he found the beaker smashed and all the contents dispersed. Last night he and Goldschmidt placed the precious material on a wooden shelf for safekeeping and went away. Someone else, who was aware of its high radiation content, then surrounded it with lead bricks but did so carelessly, because in the night

8/25/42

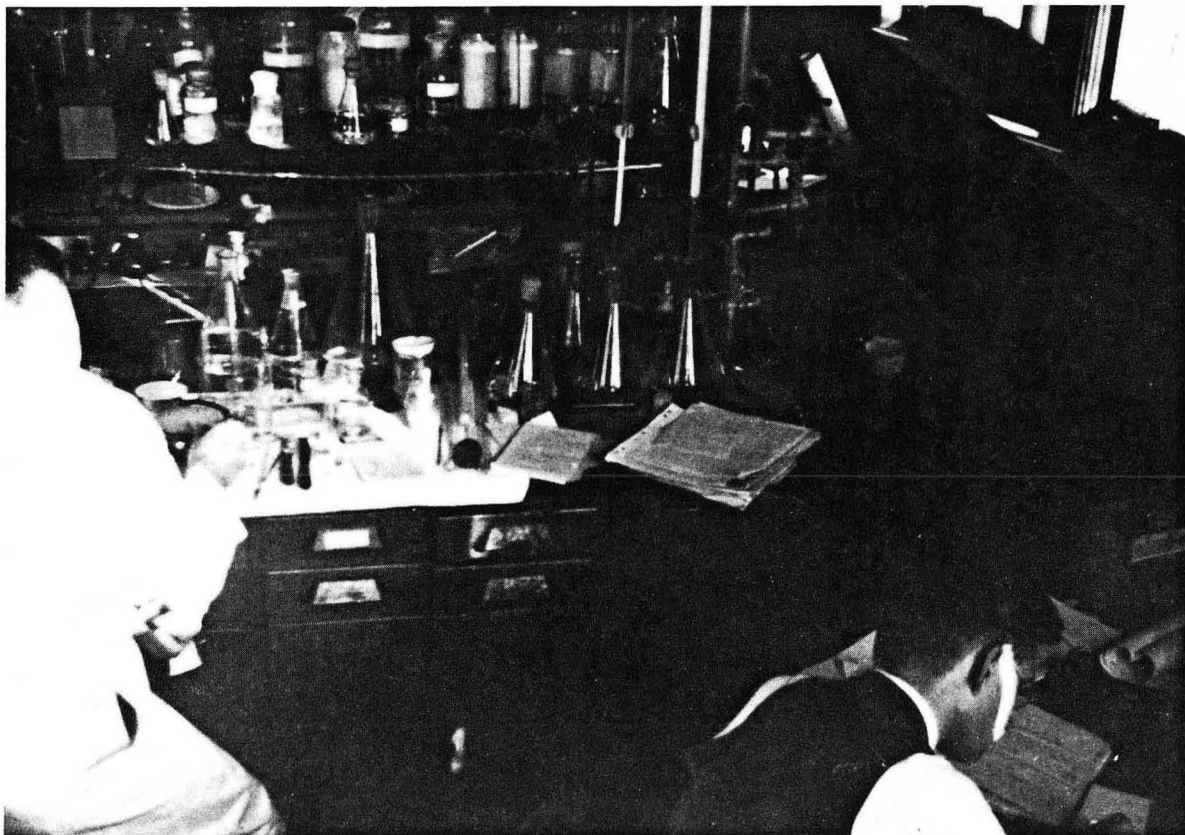

Fig. 13 John E. Willard, at desk, and Elton Turk, Room 404, Jones Laboratory, August 1942. Turk working at laboratory bench 4; photograph taken facing east. (XBB 761-7422)

8/25/42

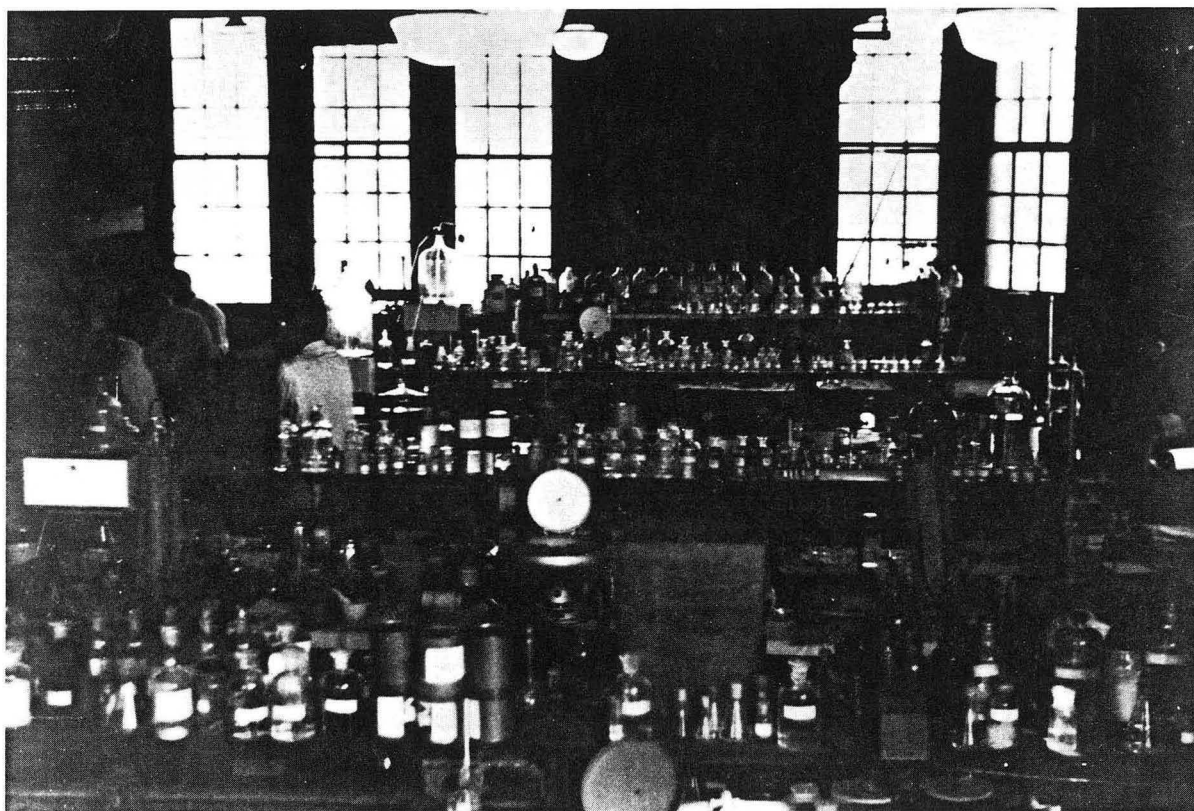

Fig. 14 Room 404, Jones Laboratory, August 1942. In near background are Ralph James and William Knox; far background, Isadore Perlman and Bertrand Goldschmidt. Photograph taken from between laboratory benches 4 and 5, facing east. (CHEM 1840)

8/25/42

one of the bricks fell over, breaking the glass beaker. It so happened that the beaker had been placed on a Sunday edition of the Chicago Tribune. Thus, when Perlman first became aware of the accident, he was staring at a soggy newspaper containing a good fraction of the world's supply of 94^{239} . His first action was to put the wet material into the largest evaporating dish he could find. Working in Room 401, he flooded it with nitric acid and is now waiting for the newspaper to digest.

Because element 94 has been considered by some to be a homologue of osmium and ruthenium, it might be predicted that it would have a readily volatile tetroxide similar to the tetroxides of these elements. English and James, however, have shown that it is not possible to volatilize 94 from aqueous ozone-ceric ion or ozone-argentic ion solutions at 90°C , or from boiling concentrated perchloric acid solutions. With this in mind, Willard tried an experiment to determine whether or not 94 can be volatilized with molten sodium peroxide, an extremely powerful oxidizing medium, at 500°C .

He first evaporated a sulfuric acid solution of 50-year 94 tracer to dryness on a square of sheet iron with the aid of a hot plate. It gave 956 alpha particle counts per minute after evaporation and before heating to about 450°C , and about the same after heating. About 20 mg of sodium peroxide was then placed on the iron square and the latter was placed on an iron block which was heated with a blast lamp to a temperature above 498°C (m.p. of PbCl_2) and below 652°C (m.p. of Al). The Na_2O_2 melted and then changed to a solid (presumably Na_2O). (The fact that the melt was alkaline probably would not prevent the volatilization of a tetroxide under these conditions because osmium and ruthenium tetroxides are volatile even from alkaline media.) Further portions of Na_2O_2 were sprinkled on the spot containing the 94 during a 10-minute period of heating. The iron square was then cooled and leached with acid. The solution obtained was precipitated in a lusteroid tube (after evaporating the excess acid) by means of HF, using 0.3 mg of La^{+3} as carrier. The precipitate gave 750 counts per minute, which probably represents a complete recovery of the initial 94 added. (About 20% loss in counting efficiency may be expected when the count is made on lusteroid, and a small loss would be expected because of self-absorption by the lanthanum fluoride carrier.)

8/25/42

It can be concluded that under the conditions of this experiment, 94 does not readily volatilize from molten Na_2O_2 at 500°C .

In order to test whether or not the negative results obtained could be credited to slowness of diffusion of PuO_4 through the molten Na_2O_2 , a further experiment may be tried. Such an experiment might consist of sprinkling tracer 94 mixed with osmium or ruthenium carrier on the surface of molten Na_2O_2 . The temperature might be lower or the oxygen pressure higher than in their experiment today in order to prevent decomposition of the sodium peroxide.

Cooper, Lewis, Moore, Spedding, Steinbach, Whitaker and I held a conference to discuss the problem of handling the 5-1/2 day xenon that would be liberated during the chemical processing of uranium oxide from a working pile. I opened the meeting by stating that the total activity of the xenon would be from one to three percent of the total activity at the end of one week. Calculations were then made of the number of curies of xenon liberated per hour during the pile operation and chemistry operation. They were based on the assumption that, if each oxide lump has an activity of 5 curies equivalent and if 3% of this is in the xenon form at the end of a week, then this would amount to 60 curies per ton. If all of this is liberated during the solution process and one plans on dissolving one ton in 24 hours, the radioactive xenon liberated would be 2.5 curies per hour.

On the other hand, 50% of the xenon may come out in the helium during the pumping operation of the pile, leaving only 30 curies per ton for removal during the chemical operation. In that case, for a pile using 40 tons of uranium oxide, one must arrange for disposal in the air of 50 curies of radioactive xenon per hour. If one considers 10^{-14} curies per cc as a safe concentration of this radioactive gas and if one takes 4 cc of 50 curies per hour as the rate at which the gas must be dispersed, then one can calculate just what dilution is necessary in order to get a safe concentration.

Cooper used a stack design formula and a dilution factor of 4×10^9 cu ft/min, arriving at a stack height of 81 feet, which seemed reasonable to us.

8/25/42

Instead of my usual weekly report, "Group C-V: Chemistry of 94," Latimer and I issued a joint report for the month, July 15-August 15, 1942, on the "Chemistry of 94. University of Chicago and University of California Groups." This is being given the report no. CN-239, the "CN" being a new designation to describe our reports on the chemistry of 94 which have limited distribution; it is a week late because of its size, running about 60 pages, and difficulty in assembling (due to delay in receipt of manuscripts) and editing so much material.

I now have six separate groups working for me, and Latimer has four. We reported on the work of each group, namely: At Chicago, I. Peroxide Method for Separating 94 (I. Perlman and W. J. Knox); II. Fluorine Method of Separating 94 (H. S. Brown and O. F. Hill); III. Solvent Partition Method for Separating 94 (T. T. Magel and D. E. Koshland, Jr.); IV. Adsorption Method for Separating 94 (J. E. Willard and E. H. Turk); V. Volatility of 94 Compounds (S. G. English and R. A. James); and VI. Ultramicrochemical Investigations on 94 (M. Cefola, B. B. Cunningham and L. B. Werner). At Berkeley, I. Transference Experiments on 94 and 93 (J. W. Gofman and R. E. Connick); II. Precipitation Reactions of 94 and 93 (R. B. Duffield and R. W. Stoughton); III. Oxidation Reactions of 94 and 93 (C. S. Garner, J. W. Gofman and J. W. Hamaker); and IV. Wet Fluoride Method for Separating 94 (A. C. Wahl and N. A. Bonner). This illustrates the redistribution of effort among the people who were working with me at Berkeley; R. E. Connick is an outstanding addition to this group.

In partial summary of the Chicago work, Perlman and Knox report their continuing work on the peroxide method for separating 94 in which they find that the thorium precipitation method (precipitation of thorium peroxide and 94 from a uranyl nitrate solution) gives the best results from $(\text{NH}_4)_2\text{SO}_4$ solution of pH 2.8. Analysis indicates about 90% of the 94 could be isolated with less than 1% of the fission product activity (in the presence of zirconium, lanthanum and cerium hold-back carriers) under these conditions. The most unsatisfactory condition in this procedure is that the concentration of uranyl nitrate hexahydrate must be less than 2%, otherwise thorium will not precipitate. Willard and Turk report their further tests to determine the most efficient operating conditions for the use of Hyflo Super Cel (HSC) in an adsorption method for separation of 94. They find that adsorption of 94 on HSC is high in pH range 3.7-2.3 and

8/25/42

that the efficiency of adsorption falls off rapidly with increasing concentrations of uranyl nitrate above 30%. Cefola, Cunningham and Werner give a complete description of the volumetric and gravimetric operations as they are carried out on the ultramicro scale.

At the meeting of my group's Research Associates this evening there was much discussion of the ultramicrochemical program of investigation and its future prospects—now more optimistic than we have anticipated. Ghiorso attended the meeting for the first time.

News from the Soviet front is bad again! The Germans have made a 50-mile advance.

Wednesday, August 26, 1942

Jaffey has been working up, since yesterday, his one-quarter, so-called "batch no. 3," of the second ether extraction on the St. Louis neutron-irradiated UNH in Room 401. His batch was a murkily yellow water layer and amounted to about 600 ml. It was repeatedly centrifuged, diluted and washed until he arrived at a clear solution of 1,300-1,500 ml volume. His assay showed that he has a total of 3.5×10^6 alpha-particle counts per minute. Working at his laboratory bench (where he performs what he calls "table-top" chemistry in contrast to the extraction operations in the attic and on the roof), the solution was evaporated until porcelain chips just barely float. As it approached this point, the hitherto clear solution started to form a yellow precipitate. It was removed from the hot plate and stirred until cool. Magnificent dry UNH crystals appeared, which weighed out to 700 grams, or one pound, nine ounces.

I wrote a long letter to Wahl about a number of topics. The first one concerned his contribution to the monthly report on "The Chemistry of 94," which appeared yesterday as a joint report of the Berkeley and Chicago groups. I said that I have eliminated his statement that the "Wet Fluoride Method" might not be as useful as some of the other methods for isolating 94 for the reason that this is by no means certain yet. I agree

8/26/42

with his deductions as to the oxidation numbers of the lower states of 94 and 93 (i.e., +4) and noted that his experiments were "fine experiments." I suggested that he try to reduce 94 to an ion with an even lower oxidation state than the +4, using a strong reducing agent such as zinc. I also suggested that we try to write a little more briefly in the future because this report turned out too long and hence was quite late in appearing.

My letter continued: "I don't know whether I agree with your decision to refer to the 50-year 94 activity as 94^{238} . It might be better to leave this question open until all the evidence is in, so that confusion could be avoided by eliminating a number of changes in the assignment. I suspect, however, that yield argument based on Gofman's thorium plus deuteron bombardment will go a long way toward settling the problem. I am almost convinced that the 50-year 94 is formed in the $d, 2n$ reaction, since it is not formed in the Chicago cyclotron (8 Mev deuterons) while the 2.3 day 93^{239} is formed in appreciable amounts (more than to be expected from stray neutrons)."

Then I elaborated on our thoughts regarding the possibility of substituting iodate for fluoride in the "Wet Fluoride Method" to avoid corrosion problems with HF-nitrate mixtures in stainless steel vessels, which I think might be horrendous.

We are publishing a joint paper on the half-life of 94^{239} , and I enclosed a draft of it with a few comments and changes. I was also happy to inform Wahl that we were able to send him a centrifuge and that the other items he asked for on August 14 will be shipped as soon as they arrive here.

I submitted a report today, "Search for Elements 94 and 93 in Nature. Presence of 94^{239} in Carnotite (CN-246) under the joint authorship of C. S. Garner, N. A. Bonner and me. This report describes our attempts to find a long-lived isotope of element 94 (as well as 93) in nature. Earlier, Morris Perlman and I in a report (Report A-146, "Search for Elements 94 and 93 in Nature. Presence of 94^{239} in Pitchblende," dated April 13, 1942) announced the discovery of 94^{239} in a pitchblende concentrate from Great Bear Lakes region, Canada, at a concentration of one part in 10^{14} ,

8/26/42

and that there was not present as much as one part in 10^9 of any other isotope of 94 or 93.

The abstract of the report submitted today reads as follows: "Samples of carnotite, fergusonite and hatchettolite were subjected to chemical treatment designed to isolate elements 94 and 93. No evidence for the presence of appreciable amounts of 94 or 93 was found, and the tests with slow neutrons and with fast neutrons established the upper limits of the concentrations of these elements as one part in 10^{10} of carnotite, one part in 10^9 of fergusonite and one part in 10^9 of hatchettolite. A small alpha-counting rate in the final sample from the carnotite indicates the presence of 94^{239} in the carnotite at a concentration of about one part in 10^{14} . The probable presence of 94^{239} in pitchblende had previously been established, and the 94^{239} in both carnotite and pitchblende is probably formed as a result of the absorption by U^{238} of some of the neutrons emitted in the uranium spontaneous fission process."

War news in Europe and the Pacific continues! In the Pacific there is a new battle in the Solomons. In the Soviet Union a million Nazis move on Stalingrad.

Thursday, August 27, 1942

Brown and Hill performed an experiment today on the volatility of the higher anhydrous chloride of 94. Some 94 tracer (50-year) was added to a uranyl nitrate solution and the whole was ignited to U_3O_8 . This was thoroughly mixed with charcoal and the mixture in a boat was treated with chlorine at $350-450^\circ C$. The reaction that took place was as follows:

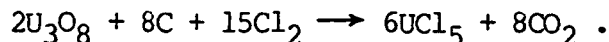

The UCl_5 left the boat and condensed in the cooler portions of the reaction vessel. At the end of the reaction, the boat was weighed and analyzed for element 94. The UCl_5 in the cool portion of the vessel was dissolved in water and also analyzed for 94. It was found that 92% of the uranium had volatilized, but at the most only 7% of the 94 had volatilized with it. Thus this preliminary experiment indicates that 94 does not have

8/27/42

a very volatile higher chloride. Further experiments, however, should be undertaken in order to test the volatility under various other conditions.

Fontana sent me a letter from Berkeley about his work with extraction of U^{234} from residues. He informed me that, after checking the sample of residue from Harshaw Chemical Company in Cleveland, he finds that it is ten times less concentrated in UX_1 at the time of its actual recovery in Cleveland than the Mallinckrodt Chemical Company's residue at the time of its recovery in St. Louis.

The St. Louis residues that he and his co-workers have completely worked up, he said, have yielded a sample of about 390 millicuries, which is equivalent to about 16 micrograms of U^{234} . This activity is contained in about one gram of naturally-occurring thorium. The opinion of his group is to allow this sample to decay rather completely, say for at least two months, before attempting to work it up for U^{234} . At present they are recovering about two additional micrograms of U^{234} from various samples, which represents the last of the U^{234} that is available, aside from the St. Louis sample. He ended his letter by saying, "As you probably already know, in view of the relatively large amount of U^{234} now available through the working of the St. Louis residue, Prof. Latimer has ordered our group to disband. Prestwood and Reed have already shifted over to work with Wahl and Friedlander, and in a few days Sheline and I are to start work on other problems. Of course in about two months I shall return to the recovery of the U^{234} grown from the St. Louis sample." He questioned my suggestion that he write a report on his work on the preparation of UX_1 , on the basis that much of the information would be a repetition of information given in Report A-172 by Perlman and Fontana, "Preparation of U^{234} Through UX_1 ," issued April 13, 1942.

John Wheeler talked at the Research Associates meeting tonight and gave an account of some problems he is working on. I always find these meetings stimulating; not only do they serve as progress meetings, but we get a chance to meet some of the newer members of the Laboratory.

8/27/42

News today is the reverse of yesterday--news from Moscow good and from the Pacific bad. The Russians advanced on the Moscow front and slew 45,000 Germans. But in the Pacific the Japanese invaded Guinea again.

Friday, August 28, 1942

I replied to Fontana's letter, thanking him for the information on the Harshaw-Cleveland residues, expressing my pleasure that he has on hand the equivalent of 16 micrograms of U^{234} , and agreeing that he should wait at least two months to allow the parent UX_1 to decay to U^{234} . I agreed that for the present we can forget about a report of his recent work on the preparation of UX_1 and said that I am sure that he, Sheline, Prestwood and Reed will find their new commitments extremely interesting.

I have learned that the new chemistry building will be ready about October 1.

Last week Helen and I went nightclubbing in the Chicago Loop with the Ghiorso's. Tonight the four of us, along with 101,096 others, went to Soldiers Field and saw the Chicago Bears beat the College All Stars 21-0. Unfortunately, we sat through a typical lake-front fog.

The Planning Board met today, and in attendance were Allison, Compton, Hilberry, Moore, Spedding, Steinbach, Szilard, Wheeler, Whitaker and Wigner. Compton talked about production of U^{235} by the electromagnetic separation and the centrifuge methods. He said that the development of the calutron has been significant in the last month or so. Lawrence has installed at Berkeley a second tank, back-to-back with the first, in the gap of the 184-inch magnet (using the magnet originally intended for a cyclotron) and his team is studying multiple sources and improved uranium-beam receivers. As for the centrifuge method, it is estimated that 15,000 kw of power will be required to produce one kilogram of pure U^{235} per day. The first material enriched by a factor of about 20% is scheduled to come to us from the centrifuge around February 1 of next year, in quantities of

8/28/42

a few kilograms per day. Thus, it would be necessary to wait until next year if we plan to construct a pile using uranium enriched in the U^{235} isotope.

Compton also reviewed the progress of heavy water production. If all the hydrogen-producing plants in the country were used, one might be able to produce 15 tons of heavy water per month; so a reasonable aim is to get five tons per month, which means that a heavy water pile could not be constructed for another year. In fact, it will not be until August of next year before the Trail plant in Canada can produce 400 kg of heavy water per month.

There was bad news that the program for building the pilot-pile plant at Argonne Forest is over three months behind in schedule. Stone and Webster Company can't promise the completion of buildings at Argonne Forest until January 1. Hence it will be necessary to get a chain reaction going at some other site, such as the armory or the West Stands. It was reported that the theoretical work at Berkeley by Oppenheimer and his group on fast fission reactions makes our work here at the Met Lab even more important than previously from a military point of view. For this reason we cannot wait for the Argonne buildings before setting up a demonstration pile. The purposes of the plant at Argonne Forest were enumerated: (1) demonstration of chain reaction; (2) measurement of pile temperature sensitivity; (3) experience with radiation; (4) experience in chemical extraction; and (5) development of control devices.

Saturday, August 29, 1942

Priscilla Greene, Lawrence's secretary, sent me a note that I thought amusing. "Professor Lawrence," she wrote, "has just received a carbon copy of a letter to you from Mr. Underhill dated August 15. He was afraid that you would be disturbed by this misunderstanding and asked me to tell you that we have informed the Regents Office that your check for \$89.25 was a reimbursement for a travel advance and not a gift to the University."

8/29/42

In Compton's "Bulletin for Week Ending August 29, 1942," Whitaker describes the facilities to be provided at Palos Park at the Argonne Forest site. The experimental plant (which we are now supposed to call the Pilot Plant) will be housed in eight principal buildings plus several service buildings, such as the heating plant and water supply plant. The eight buildings are to be called the Main, Engineering Development, Chemistry-Biology Laboratory, Shop, Sintering, Chemical Storehouse, Pile and Separation Plant buildings. They will be fenced in and carefully guarded.

The plan calls for building two active piles at the site, but it was conceived, and Whitaker's report was written, before the Planning Board met yesterday, after which it was announced that construction is more than three months behind schedule and that the first working pile should be erected in the Armory or West Stands. According to Whitaker's report, pile No. 1 would not be built inside a radiation shield but would be assembled as quickly as possible to get a reaction going. The activity would be kept low so that some preliminary studies could be made. Then the material would be transferred to the Pile Building where pile No. 2 would be assembled with radiation shielding so that it could be operated at considerable power. There would be two sliding sections into the pile, from which material could be taken for chemical study. In addition there would be a four-by-four inch port for inserting samples to be irradiated. A study is being made on how to cover pile No. 2 with a gas-tight cover so that it can be evacuated before operation and filled with an inert gas such as helium. A major effort is being put into designing mechanical handling devices for taking down a pile once it has operated and transferring active materials to the Separation Plant Building.

The measurements of the reproduction factor k in graphite-uranium oxide systems have been made so far by measurements of intensity in the exponential (intermediate) piles. Fermi reported on experiments performed on exponential piles No. 10 and No. 11. Up to now the sizes of the exponential piles have not varied between wide limits. Indeed, the sides have ranged from 90 to 96 inches. As a check on the reliability of the theoretical interpretation of the measurements, it appeared worthwhile to perform a measurement at least once using the same internal lattice geometry on

8/29/42

two piles of widely different dimensions. The two piles compared in this way were No. 10 and No. 11. The lattice was the same in both piles, namely, a cubic lattice of eight-inch cell side with cylindrical lumps of pressed UO_2 having a diameter and height of about three inches and a total mass of about two kilograms. The side of the pile used in pile No. 10 was 92 inches. Pile No. 11 had the same internal structure but a side of 132 inches. Fermi and his group found that the most probable value for the reproduction factor in pile No. 10 was $k = 1.014$, and for pile No. 11, k was between 1.012 and 1.013, slightly lower.

Two other reports were included in Compton's "Bulletin." Wollan reported on a study of diffusion as a means of bringing fission products from the uranium metal into the cooling gas. Snell reported on the work of R. G. Wilkinson and S. J. Levinger of his group, who have been studying the neutron-induced radioactivity of commercial iron.

Sunday, August 30, 1942

Newspaper headlines this morning say that the U.S. Marines are holding six islands—meaning Guadalcanal—and that the Nazis are repelled at Stalingrad.

Monday, August 31, 1942

Today Cunningham and Werner are beginning to work on Perlman's one-fourth portion of 94^{239} fraction isolated from the large St. Louis cyclotron bombardment. The solution contains an amount of 94^{239} corresponding to about 5×10^6 alpha disintegrations per minute (about 45 micrograms on the basis of a half-life of 30,000 years and 45% alpha-particle counting efficiency) in a volume of 40 cc; and, although it is free of La^{+3} carrier, it contains considerable Ag^+ and K_2SO_4 and presumably some other inorganic substances and considerable quantities of impurities because of the problems of recovering the material from the spill. Their aim is to isolate pure samples of 94^{239} to determine its specific alpha activity by weighing such samples and to produce a number of compounds of

8/31/42

94 in order to observe their properties. They ran through an oxidation-reduction cycle to reduce the total volume to a few cc, returned about one-third of the 94 to Perlman and divided the other two-thirds equally between themselves and Cefola.

Cefola also started to work today on his portion of this source of 94^{239} , starting with a one ml solution containing about 15 micrograms, which also contains $S_2O_8^{-2}$, SO_4^{-2} and Ag^+ ion. His purpose also is to try to isolate pure samples of 94 using oxidation-reduction cycles and lanthanum fluoride as carrier.

Brown and Hill concluded their experiments started last Monday on the volatilization of fluorides of uranium and 94 as a function of temperature. Several samples of UF_4 containing 94 tracer incorporated by the anhydrous method were fluorinated at various temperatures for an arbitrary interval of 30 minutes and the percent of element 94 volatilizing at a given temperature was measured. They find they can remove the uranium as UF_6 and leave the 94 behind at fluorination temperatures up to about $300^\circ C$, then remove the 94 as a volatile higher fluoride by fluorination at a higher temperature. Their experiments, however, do not indicate whether the higher temperature is required for the 94 fluoride in order to volatilize it or merely in order to synthesize it. Experiments on passing the 94 higher fluoride through copper tubing ($175^\circ C$) show that it condenses; this might be due either to low volatility or to instability.

I wrote to Latimer, who has returned to Berkeley, concerning a letter to be written to William G. Paden, Superintendent of Schools, Alameda, California, thanking him for his generosity in releasing Charles Blanchard from his teaching contract for the coming year so that he can work full-time on the Berkeley project.

Coryell has finished his notes on my lecture series on nuclear chemistry and, together with an index prepared by Ralph James, it is being published as a 71-page document for Metallurgical Project use under the title "An Introduction to Nuclear Chemistry."

SEPTEMBER 1942

Tuesday, September 1, 1942

Kohman, Jaffey and Goldschmidt are continuing the process of isolating 94 from their batches (numbers 2, 3 and 4) following the ether extraction procedure on UNH bombarded by neutrons in the Washington University cyclotron; much of their work is being done in Room 401.

Today we sent by truck to Washington University in St. Louis the 300 pounds of purified Mallinckrodt UNH, which we recrystallized early last month, for bombardment with neutrons at the 45-inch cyclotron. We have asked for a bombardment of 100,000 microampere-hours this time, which is scheduled to begin September 5. It is called the Chicago II sample. Portions of this UNH will be sent to us as the irradiation proceeds in order to monitor its progress. We also are inaugurating a program of irradiating 200-gram samples of UNH on a bi-weekly schedule, each for about 5,000 microampere-hours, to serve as a source of 93^{239} and short-lived fission products.

Several new men from the du Pont organization arrived at the Lab to join Charles M. Cooper in his chemical engineering group. They are: Richard S. Apple, Luther C. Peery, Donald S. Webster, Frank B. Vaughan and P. S. Vincent. They will form the nucleus of the Engineering Extraction Group personnel.

I met with the Research Associates of my group in my office this evening. We talked about the role that the newly arrived chemical engineers might play in working with our fellows on the 94 extraction processes. Progress on the extraction of 94 from the 300 pounds of neutron-bombarded UNH was also discussed, in addition to the regular progress reports on the individual research efforts.

The war in Africa is back in the news today. The Nazis under Field

9/1/42

Marshall Erwin Rommel have reopened a drive in Egypt after a two-month lull.

Wednesday, September 2, 1942

Last week Gofman phoned to tell me that he is having trouble with the resolving power of his counting circuitry. After talking the problem over with English and Ghiorso, I wrote to Gofman today and gave him some hints as to how to modify his amplifier. I also enclosed a circuit diagram and invited him to phone either English or Ghiorso if he needs further counseling. In a second letter to Gofman, in answer to his question whether or not to use the old 3.5-microgram sample of 94^{239} (sample M) in his fast neutron measurements, I advised him to get a new five or ten microgram sample, either from Wahl or from us.

The headlines today say that U.S. air and land troops are fighting Rommel.

Thursday, September 3, 1942

Knox is continuing the studies of the behavior of 94 and fission products upon precipitation from peroxide solutions. Today he is starting a series of experiments to determine the completeness of thorium peroxide precipitation from $(\text{NH}_4)_2\text{SO}_4$ -UN solutions with hold-back carriers.

Perlman and Goldschmidt are industriously pursuing their experimental survey of long-lived fission products. Before long (we hope) we will be confronted with the separation of 94^{239} from uranium and fission products in vast amounts, and so it is imperative to know the composition of fission mixtures at different times after production has ceased. There are two aspects of the problem that demand consideration: (1) the identification and yield of beta-particle emitters, which is important because of the energy liberated, and (2) the identification and yield of gamma-ray emitters which is important because of their hazard to the workers concerned.

9/3/42

From a literature survey that I made in 1940 [and published in Chem. Rev., 27, 199 (1940)], we can deduce that of the isotopes formed in uranium fission, namely, those of atomic number 35-44 and 51-58, inclusive, those with half-lives greater than three days have atomic numbers 38 (Sr, 55 d), 39 (Y, 57 d), 40 (Zr, 26 d), 51 (Sb, 80 hr), 52 (Te, 77 hr, 32 d, 90 d), 53 (I, 8 d), 54 (Xe, 5.4 d), 55 (Cs, many yr), 56 (Ba, 300 hr), 57 (La, 44 hr), 58 (Ce, 20 d, 200 d). These isotopes are not genetically related except the 44-hr La, which is the daughter of the 300-hr Ba, and the 90-day Te, which is the daughter of the 80-hr Sb. None of the others is known to have radioactive daughters.

All these isotopes were identified initially by the beta activity. Nothing much is known about their gamma-ray activity, except for the 8-day iodine and 44-hour lanthanum. It is the intention of Perlman and Goldschmidt in their present experiments to find and characterize (by their beta and gamma radiations) all radioactive fission product isotopes, presently known and unknown, so we can devise a chemical procedure to separate 94^{239} from them; the fission product activity that exists some 90 days after production is important to have information about because this is the anticipated cooling time for pile-irradiated uranium before the chemical separation of the 94^{239} . They obtain the fission product mixtures from the two samples of UNH that were irradiated with neutrons, the bombardment of Berkeley ending June 20 and the other at St. Louis ending July 20. Their experiments should be concluded in about two weeks from now. Their study is being carried out with two objectives: (1) to establish suitable methods for rapid analysis of fission mixtures for their beta- and gamma-radiating components, and (2) to obtain approximate abundances of the fission products.

Two methods of analysis are being employed by Perlman and Goldschmidt in their current experiments: (1) analysis for a single element or a small group of elements when this is the only information desired, and (2) complete analysis for all active elements with a minimum number of operations. In (1), the procedure for isolation of individual elements, sometimes they first precipitate some of the other radioactive fission products in order to eliminate them as completely as possible before precipitating the element they are seeking. Then the radioactive element being sought is brought down and measured for both its beta and gamma

9/3/42

activity. In (2), the procedure for complete chemical analysis, carriers plus concentrated HCl are added at the beginning to a solution of uranyl nitrate containing the fission products, and then a series of precipitations and filtrations are used to isolate each radioactive element in turn. Perlman and Goldschmidt are making good progress with their analyses, and they assure me that they will get enough data so that we can develop our large-scale chemical procedures with confidence.

Hamilton is here at the Laboratory to confer with Whitaker and Fermi about the hazards of personnel exposure to fission products. It is his opinion that a concentration of 7×10^{-6} curie of Xe^{133} per liter of air is approximately the maximum safe concentration for breathing 24 hours per day (using 0.1 r per day as the maximum dose for tissue). Furthermore, 10^{-5} curie of barium active deposit per liter of air would perhaps be fatal in one day. He also believes that a dose of 500 roentgens over the entire body is perhaps a fatal amount, but that 10 r in one day would not be troublesome if the integrated radiation over several months is kept within an accepted safe value. There is some evidence that approximately 100 millicurie-years is the order of magnitude of the amount of radiation from deposited radium which is fatal.

The Allied defense of Egypt held fast for the third day, but the real battle has not yet been joined.

Friday, September 4, 1942

Steinbach called me on the phone and asked if I could send someone over to review the drawings for our floor plan in the new chemistry building. I sent Covey, who is familiar with the layout of our future laboratory and who has been ordering furniture and equipment in preparation for our move. The erection of the building is well under way, and it is just possible it will be completed by the October 1 deadline.

As I mentioned earlier, the Planning Board last Friday decided to erect pile No. 1 in the Armory or West Stands on the campus and pile No. 2

9/4/42

at the Palos Park Site (Argonne Forest Preserve). Now I have learned that pile No. 1 will be built under Zinn's direction and that either Compton or Fermi has proposed that a special group be set up to take over the experimental work on the technological features of pile No. 2. This has engendered some strong feelings because it is thought that the men in this group are most urgently needed in carrying out the increased program at the campus pile. Whitaker and Fermi met on Wednesday to resolve the situation. So it is proposed that this group work in both places, assisted by several new Research Associates. Fermi and Whitaker also discussed the problems of radiation doses from radioactive gases and radiation doses in general and decided to explore this further with the Medical Group.

N. P. Heydenburg, at Manley's request, sent me a letter from his laboratory in the Department of Terrestrial Magnetism, Carnegie Institution of Washington, suggesting that we send him ten micrograms of 94^{239} deposited on thin platinum foil. He intends to use it for fast-neutron fission cross section measurements. He said, "Ten micrograms of the material should be satisfactory if the cross-section is similar to that of 25." I think we will be able to oblige him in a few weeks.

I received a letter from Wahl in Berkeley, enclosing a copy of our draft report on the half-life of 94^{239} , with comments and suggestions. He wrote about a number of other topics, the most important being that covered in his paragraph, "I believe the assignment of the mass number 238 to the 50-year 94 activity is nearly certain. Deuteron bombardments of alloy and Al give the same yields of the 50-year 94 making it certain that the 50-year isotope is made from Al. This work was reported over a month ago." By "alloy" and "Al," Wahl meant normal uranium and U^{238} depleted in U^{235} , respectively. English and I have come to the same conclusion about the isotopic assignment of 50-year 94, based on English's recent work; I shall ask him to prepare a report on it.

Wahl was pleased that his group has finally received an AA-3 priority rating. He thanked me for the centrifuge and will have Latimer sign a receipt for it when he returns to Berkeley. Regarding his current work, he said that they are studying a possible iodate method for the separation

9/4/42

of 94^{239} from fission products and uranium because he is worried about the chemical reaction of HF and HF-HNO₃ mixtures on stainless steel. He also noted, "We have not looked for Pu⁺³ as yet, but it is on our program. There are more jobs than there are hands to do them." He said they now plan to write reports at two-week intervals.

I sent the New York Central Railroad Company a personal check for \$38.59. This is to cover round-trip fare and Pullman to Buffalo, New York, where I will be presenting a paper at the American Chemical Society meeting on September 8. While I am in Buffalo, I would like to see the chlorine production facilities at the Hooker Electrochemical Company in Niagara Falls, which was visited by Brown last month. In an exchange of telegrams today, I have been invited to visit them the morning of September 9.

The British have forced the Axis army back on the Egyptian front. In addition, there is renewed fighting in the Pacific in the Solomon Islands.

There was a meeting of the Technical Council, attended by Allison, Boyd, Compton, Doan, Fermi, Grafton, Hilberry, Moore, Nichols, Spedding, Steinbach, Szilard, Wheeler and Wigner. There were discussions regarding the pilot plant (pile No. 2) planned for the Argonne Forest Preserve. Compton remarked that Wigner's idea for cooling the pile by means of water, as an alternate to the use of helium, justifies further planning. Allison told the group about our isolation of 94 by microchemists and that the quantity is sufficient to be seen. Spedding reported that the present yield of uranium metal by the reaction of UF₄ with calcium is 82%. Doan added that in a few weeks there will be no bottleneck in obtaining UF₄. Wheeler reviewed the problems of radiation protection. He also remarked that the chain reaction in a uranium graphite pile will be thermally unstable if the lattice spacing is too great.

Saturday, September 5, 1942

Knox is finding that something is inhibiting the thorium peroxide precipitation. After conducting a number of experiments yesterday and today, he finds that zirconium, which is present as hold-back carrier in the original solution, inhibits thorium from quantitatively precipitating-- it seems to hold back an equivalent amount of thorium. He has learned that La^{+3} and Ce^{+3} , on the other hand, do not inhibit thorium precipitation. He also has experimented with titanium and concludes that Ti^{+4} is not a good hold-back carrier for fission product zirconium in this process.

Willard and Turk are still exploring the use of columns of diatomaceous earth, Hyflo Super Cel, in isolating 94 by the adsorption method. So far they have found that the HSC has the ability to selectively adsorb tracer quantities of 94^{238} (50-year half-life) from solutions of uranyl nitrate and fission products, and thus may be a potential means of concentrating the 94^{239} that will be produced in operating piles. Their past experiments show that (1) more than 90 percent of the 94^{238} is adsorbed from 10% solutions of $\text{UO}_2(\text{NO}_3)_2 \cdot 6\text{H}_2\text{O}$ at their natural pH of about 2.5, while less than five percent of the uranium and less than 20 percent of the fission products are adsorbed; and (2) the efficiency of adsorption falls off with increasing uranyl nitrate concentration and decreasing pH.

It is obvious that their success with tracer amounts of 94^{238} may not be applicable when weighable amounts of the element are placed in the column. Experiments have been conducted the last few days to determine the efficiency of the Hyflo Super Cel in adsorbing high concentrations of 94^{239} that will result from operation of the experimental pile (estimated at one gram of 94 to one ton of uranium, roughly one part in 10^6). Because weighable amounts of 94 were not available to them, they resorted to an artifice. They compared the adsorption of thorium (1) when present in a 10% solution of UNH in only tracer quantities as UX_1 and (2) when present in higher concentrations as ordinary Th^{232} (labeled with UX_1). The percent of thorium adsorbed in the process was determined by measuring UX_1 beta activity of aliquots of the input and output liquids. They were pleased to find that, using 10% UNH solution, 99 percent of thorium as UX_1 is adsorbed for tracer quantities of thorium

9/5/42

(1.5×10^{-11} ratio by weight of UX_1 to uranium metal), which only drops to 98 percent when the ratio of thorium to uranium rose to 2.8×10^{-7} , the latter concentration being the order of magnitude of 94^{239} present in the experimental pile products. Earlier work has shown, however, that the adsorption of UX_1 falls off dramatically when the ratio of thorium to uranium reaches the level expected for the 94 to uranium ratio in production pile material.

The 300-pound sample of Mallinckrodt UNH that we recrystallized last month and shipped to the Washington University cyclotron in St. Louis last Tuesday commenced its neutron irradiation today. I have asked for a neutron bombardment corresponding to 100,000 microampere-hours of deuterons on beryllium. If all goes well, the irradiation should be completed in seven or eight weeks.

We finished preparing "Report for August 16-31, 1942. Chemistry of 94. University of California and University of Chicago Groups" (No. CN-250). In our part this includes a section by Cunningham, Cefola and Werner on "Ultra Microchemical Investigations on 94" in which they describe the first isolation of compounds of pure element 94; a section by Willard and Brown, "Volatility of 94 Compounds," in which they describe their unsuccessful attempts to produce a volatile 94 oxide or chloride; and a section by Brown and Hill, "Fluorine Method for Separating 94," in which they describe their experiments on volatilization of UF_6 and non-volatilization of 94 higher fluoride below $300^\circ C$ and the volatilization of 94 higher fluoride at $500^\circ C$. In the California part there are sections on "Precipitation Reactions of 94 and 93" by Duffield, "Reduction Reactions of 94 (o)" by Hamaker, and "Oxidation Reactions of 94" by Garner and Gofman.

Doan issued a bulletin on the state of production of materials involved in the pile technology. A total of about 55 tons of D-1 grade of uranium oxide has been received from the Port Hope Refinery of the Canadian Radium and Uranium Corporation to date, and all this has been sent to Mallinckrodt for purification. In addition, about 20 tons of commercial grade oxide, including the old Columbia University oxide and oxide received at Chicago prior to the beginning of the D-1 grade shipments, have been sent to Mallinckrodt, and apparently the purified product from

9/5/42

this material is about as good as that which results from the purification of the purer D-1 grade. Present plans are to continue the shipments of D-1 oxide from Canada until the end of September and then shift over entirely to the commercial grade.

Mallinckrodt is now set up to produce the purified dioxide at a maximum rate of about 9 tons per week on a seven-day basis, provided they can be supplied continuously with enough oxide to keep their process in full operation. So far the amount of oxide received from Canada has not quite been sufficient to accomplish this. A recent shipment of about 12 tons of commercial oxide has been made direct to Mallinckrodt in St. Louis, and this should help to fill in the intervals when D-1 oxide is unavailable. The purity of the Mallinckrodt production has been exceptionally good and shows negligible absorption on the neutron test.

A total of one ton of uranium metal in the form of pressed and sintered cubes 1" x 1" x 1/2" has been shipped to Chicago by Metal Hydrides up to the end of last week. Analyses recently completed on this material show that it contains a number of objectionable impurities in quantities too high to be acceptable. This applies particularly to titanium, nitrogen and chlorine. Steps are being taken to improve the content of the Metal Hydrides product but it is not certain to what extent this can be done.

Westinghouse has shipped about 600 pounds of high-quality fused metal cubes 1" x 1" x 1" and are continuing the shipments at the rate of 100 pounds per day. Analyses so far made on this material show it to be of acceptable purity. Westinghouse is continuing to produce metal at a rate of about 125 pounds per day, using both the green salt (uranium tetrafluoride) made in limited quantities by photochemical reaction on the roof, and also the uranium tetrafluoride which is now beginning to come in from du Pont. There appears to be no possibility of a substantial increase in production beyond perhaps 150 to 175 pounds per day from Westinghouse within the next several months. Uranium tetrafluoride is now being produced at the rate of about 200 pounds per day by du Pont and between 50 and 100 pounds per day by Harshaw.

On the European war front the Soviets have halted the Nazis at the gates of Stalingrad.

Sunday, September 6, 1942

The Chicago Sun has a mixture of headlines this morning. The important war news is that the Soviets have repulsed Nazi assaults at Stalingrad. Other items include recommendations of Bernard M. Baruch's rubber committee and sensational spy stories.

Monday, September 7, 1942

The purpose of the two neutron bombardments of uranyl nitrate hexahydrate, one of 210 pounds that was irradiated at the Berkeley cyclotron from April 24 to June 20, and the other of 300 pounds that was irradiated at the St. Louis cyclotron from June 17 to July 22, is to provide pure, carrier-free 94^{239} in sufficient amounts for some planned chemical and physical experiments. Wahl, with the help of others, is using ether extraction and the oxidation-reduction process to separate the 94^{239} from the Berkeley UNH sample, and here, Jaffey and Kohman have supervised a first and second ether extraction of the St. Louis sample and along with Perlman and Goldschmidt (one-fourth portion each), have been concentrating the 94^{239} using the oxidation-reduction process. Perlman has already finished concentrating his portion (batch no. 1) and turned it over to Cunningham, Werner and Cefola. Approximately 200 micrograms of pure 94^{239} are expected from each of the bombarded samples.

Last month on the 20th, Cunningham and Werner isolated for the first time a compound of pure 94, free of any contaminants, but in an amount (about a microgram) only sufficient to be seen under a microscope. Now their immediate goal is to isolate a weighable amount of pure 94 compound. They have spent the last week attempting to isolate pure 94^{239} from their share of Perlman's one-fourth portion containing about 15 micrograms. Their starting solution was contaminated with considerable extraneous material as a result of the recovery of this material following the spill. They have attempted to isolate pure 94 through the application of a number of oxidation and reduction cycles using $S_2O_8^{-2} + Ag^{+3}$ as oxidizing agent, H_2O_2 as reducing agent, and diminishing amounts of La^{+3} carrier, and have

9/7/42

precipitated what appears to be relatively pure 94 fluoride in the form of a gelatinous pale yellow precipitate. From measurements of the alpha particle activity from the supernatant solution of 94 fluoride in 6 M HF to be of the order of magnitude of 10 milligrams 94 per liter of solution. They dissolved this precipitate in concentrated sulfuric acid and then precipitated the hydroxide by the addition of NH_4OH , which they observed as a yellow-brown flocculent precipitate with a solubility of about 4 milligrams of 94 per liter. When they dissolved the hydroxide in nitric acid and evaporated it to dryness, they observed a yellowish crystalline precipitate, presumably 94 nitrate. However, when attempts were made to dissolve this, there were indications that it was not pure; and, when it was placed on a platinum weighing boat and ignited, the resultant weight was apparently too large indicating the presence of some impurity like $(\text{NH}_4)_2\text{SO}_4$. They then dissolved the material, presumably a 94 oxide, finding that the presence of ceric ion in the H_2SO_4 aided this solution process. In order to try to improve the purity they put the material through another oxidation-reduction cycle, converted the isolated 94 fraction to the nitrate, then precipitated the 94 as the iodate by adding saturated KIO_3 to the HNO_3 solution. This was then converted to the hydroxide, by treatment with concentrated ammonium hydroxide, which was dissolved in acid, converted to the nitrate by addition of concentrated HNO_3 , again transferred to a platinum weighing boat previously weighed on their Salvioni balance and ignited at about 600°C . The platinum weighing boat plus 94 oxide residue was then weighed, indicating that the residue weighed 2.27 micrograms. A rough measurement of the total alpha particle activity indicated about 76,000 alpha disintegrations per minute. There are indications, however, that this 94 oxide is impure.

The personnel director of Paramount Pictures in Hollywood wrote a letter to C. R. Moulton, our Met Lab director of personnel, regarding his objections to releasing Baumbach to us on a leave-of-absence basis. He stated that many of their men have left for research projects at M.I.T., New London (Columbia University's project), University of California, Cal Tech and Point Loma; and in none of these cases has the man been promised reinstatement. He went on to say the the U.S. Government expects Paramount Pictures to continue making training films for the Army and

9/7/42 .

Navy, propaganda films for the American public and entertainment films for the armed forces and the public to keep up morale. It is essential, therefore, that their studios retain some of their key personnel who cannot be replaced by a short period of training.

I wrote to Baumbach and expressed my disappointment in his administration's attitude. I said the next move in the negotiations would be up to him as there are no recommendations I can think of.

I sent a letter to Kamen in Berkeley to ask him to estimate how much neutron irradiation the three small packages that I sent him July 17 have received in the 60-inch cyclotron.

Robert G. Sproul, President of the University of California at Berkeley, sent me a letter that I consider sufficiently interesting to quote in full:

"Dear Professor Seaborg:

"Dean Hildebrand has shown me your letter of July 17, expressing surprise and disappointment at the salary named in the contract which was mailed to you by the Secretary of the Regents.

"I can well understand your feeling, and because we have a high opinion of you here and want not only to keep you in the University of California, but to keep you as an enthusiastic member of our company, I wanted you to know that the failure to grant you an increase in salary at this time represented a purely technical situation and not our opinion of your quality. The Regents have a rule that neither promotions nor increases in salary shall be granted to men who are going on leave of a year or more. The question of the salary to be received by such men on their return is, of course, considered, without prejudice, in the light of their previous record in the University and the work that they have done while they are away. I am glad to be able to say to you that, if you had not taken a leave, I should have recommended to the Regents that your salary for this year be increased, and that I believe that my recommendation would have been accepted.

9/7/42

"I hope that the work that you are now doing, which I understand is of the greatest importance, is going along well, and that you are happy in it. However, on all grounds, I trust that you may soon be back with us and that I may be able to give to you concrete evidence of the good will which I am expressing toward you in this letter."

Today's news says that Rommel was hurled back to his starting point in Africa. But on the Russian front the Germans claim capture of the last big port on the Black Sea.

When I boarded my New York Central train a little after 8:00 p.m. at Woodlawn Station to take off for Buffalo, where I am giving a talk to the American Chemical Society, my Pullman, Lower 11, was already made up. This forced early retirement for the night is sometimes welcome, as it gives a person time for introspection and a chance to review and evaluate future plans.

Tuesday, September 8, 1942

I spent most of my day in Buffalo at the meeting of the American Chemical Society (the Division of Physical and Inorganic Chemistry). I saw several pre-Met Lab friends and acquaintances and heard some interesting talks. Mine was entitled "Review of Artificial Radioactive Isotopes," and I was pleased to find the audience so attentive. I confined my remarks to radioactive isotopes of the first 92 elements, saying that on the average there are about four radioactivities for each one. I said that those most useful in atom-tagging experiments are radioactive hydrogen, with a half-life of 30 years, and two forms of radioactive carbon, the first having a half-life of 20 minutes and the second a very long half-life, namely, thousands of years, and I described experiments done with these. I also discussed chemical and biological experiments done with phosphorous of 14 days' half-life, sulfur of 88 days' half-life, plus chlorine, bromine and iodine, which have half-lives of 37 minutes, four hours, and eight days, respectively.

Wednesday, September 9, 1942

The city of Niagara Falls is only a short ride from Buffalo. It is my first trip here, and I am impressed at the spectacular view of the Falls. The people at the Hooker Electro-Chemical Company were especially generous with their time, and they took me on a complete tour of inspection of their facilities. They are set up for the production of chlorine on a large scale, and the purpose of my visit is to assess the possible application of similar equipment for the production of fluorine in vast quantities to be used in the dry fluoride separation process.

Thursday, September 10, 1942

During the last couple of days Cunningham and Werner have been working to establish the degree of purity of the precipitate of 94 oxide that they weighed on Monday. When the 94 oxide was dissolved off the platinum weighing boat with H_2SO_4 , they oxidized with $S_2O_8^{-2} + Ag^{+2}$, followed by the addition of HF; unfortunately a precipitate appeared which must be caused by unremoved La^{+3} . This indicated that something has been holding back some La^{+3} during the LaF_3 precipitations; this led Cunningham and Werner to make an investigation of this phenomenon through the use of tracer experiments with radioactive lanthanum fission product. From these experiments they were able to conclude that the concentration of HNO_3 must be about 1 M (the concentration had been higher in their experiments) in order to insure the complete precipitation of the lanthanum fluoride from the $S_2O_8^{-2} + Ag^{+2}$ solution. They also concluded this oxidizing agent is perhaps the best to use in the oxidation-reduction cycles. Although they have been unsuccessful so far in isolating pure 94, they feel that they have now established the procedures for doing so.

Thus prepared, today Cunningham and Werner are tackling experiments with Kohman's cleaner one-fourth portion (batch no. 2) of 94^{239} isolated from the large St. Louis bombardment of UNH with cyclotron neutrons. According to Kohman's analysis, this solution contains about 8×10^6 alpha particle disintegrations per minute, corresponding to about 70 micrograms of 94^{239} , in a volume of about 18 cc, together with a few inorganic (such

9/10/42

as AgNO_3 and K_2SO_4) and other contaminants. They began by removing the 94 as the insoluble fluoride by co-precipitation with a milligram of La^{+3} . This precipitate was dissolved in a volume of 1 ml with the help of H_2SO_4 , oxidized with $\text{S}_2\text{O}_8^{-2} + \text{Ag}^{+2}$ in the presence of 1 M HNO_3 , and the La^{+3} precipitated as the fluoride by the addition of HF. After removal of the precipitate, two drops of 30% hydrogen peroxide were added to reduce the 94 (no visible precipitate appeared), 100 micrograms of La^{+3} were added as carrier, and the lanthanum fluoride precipitate incorporating the reduced 94 was removed by centrifugation. This precipitate was dissolved in 250 λ of H_2O with the help of H_2SO_4 , and the solution again oxidized in the same manner. The La^{+3} was precipitated as the fluoride, and after its removal the 94 was reduced by fuming with H_2SO_4 in a platinum microcrucible and precipitated as the hydroxide in carrier-free form by the addition of five drops of concentrated NH_4OH . The hydroxide was packed by centrifugation in a microcone, dissolved in concentrated HNO_3 solution to which KIO_3 was added to precipitate carrier-free form plutonous iodate. This appeared as a white bulky crystalline material. After washing with HNO_3 and KIO_3 solution, the iodate was transformed into a pale yellowish green flocculent 94 hydroxide by the addition of concentrated NH_4OH . Measurements on the alpha activity in the supernatant solutions indicated a solubility of about 0.020 grams 94 per liter for the plutonous iodate [whose formula is presumably $\text{Pu}(\text{IO}_3)_4$] and about 0.004 grams 94 per liter for the plutonous hydroxide [whose formula is presumably $\text{Pu}(\text{OH})_4 \cdot \text{XH}_2\text{O}$], using the name "plutonium" for element 94 as suggested by Wahl and me in our Report A-135 ("The Chemical Properties of Elements 94 and 94") issued last March. The pure hydroxide was dissolved in concentrated HNO_3 and upon evaporation to dryness, the lemon-yellow crystalline plutonous nitrate [presumably of formula $\text{Pu}(\text{NO}_3)_4 \cdot \text{XH}_2\text{O}$] appeared. This was dissolved in a small volume of water resulting in a solution of pale yellow-green color. A portion of this solution was delivered onto a platinum weighing boat which had been weighed on our Salvioni balance. The sample was dried and ignited to form the plutonium oxide and the boat was again weighed. By subtraction the weight of the oxide was found to be 2.77 micrograms.

This is the first weighing of pure plutonium, in fact the first weighing of any synthetic element, making this a historic day. I intend to preserve this sample, for posterity, even though it means removing a

9/10/42

precious quantity of plutonium from our experimental program.* I am glad that I was present to keep in touch with today's dramatic events. The alpha activity of the sample was roughly determined to be about 263,000 disintegrations per minute, which corresponds to a disintegration rate of about 110,000 alpha particle disintegrations per minute per microgram of plutonium element, assuming the formula of the oxide to be Pu_2O_5 and the molecular weight of plutonium to be 239. (We assume the counting efficiency of our "inside" alpha-particle counter, used to measure the alpha-particle emission rate of an aliquot sample, is 45%.)

We have now seen pure compounds of 94 (plutonium) and weighed a compound of plutonium, results which should give great impetus to the Met Lab's program of producing and separating gram and kilogram quantities of this treasured element.

War front reports are all depressing today. The Nazis claim they have driven to the edge of Stalingrad. At the same time the Japanese have broken through a mountain range on Guinea and are only 44 miles from Port Moresby, keystone of New Guinea defenses.

Friday, September 11, 1942

Today Cunningham and Werner worked on the remaining plutonium nitrate solution of yesterday. They converted the plutonium to the hydroxide by the addition of NH_4OH , dissolved this in HNO_3 and precipitated the iodate by the addition of saturated KIO_3 solution. After washing, this precipitate was converted to the hydroxide by the addition of concentrated ammonium hydroxide, washed, dissolved in acid and then reprecipitated as the hydroxide. As Cunningham and Werner's notebook states at this time, this hydroxide precipitation was made "for the purpose of displaying the pure material to certain interested persons. After this material was returned..." You can imagine how interested we were in showing off and

* This sample was later photographed by Covey (see Figure 15). It has been preserved and is now on display in the Lawrence Hall of Science on the Berkeley campus of the University of California.

9/11/42

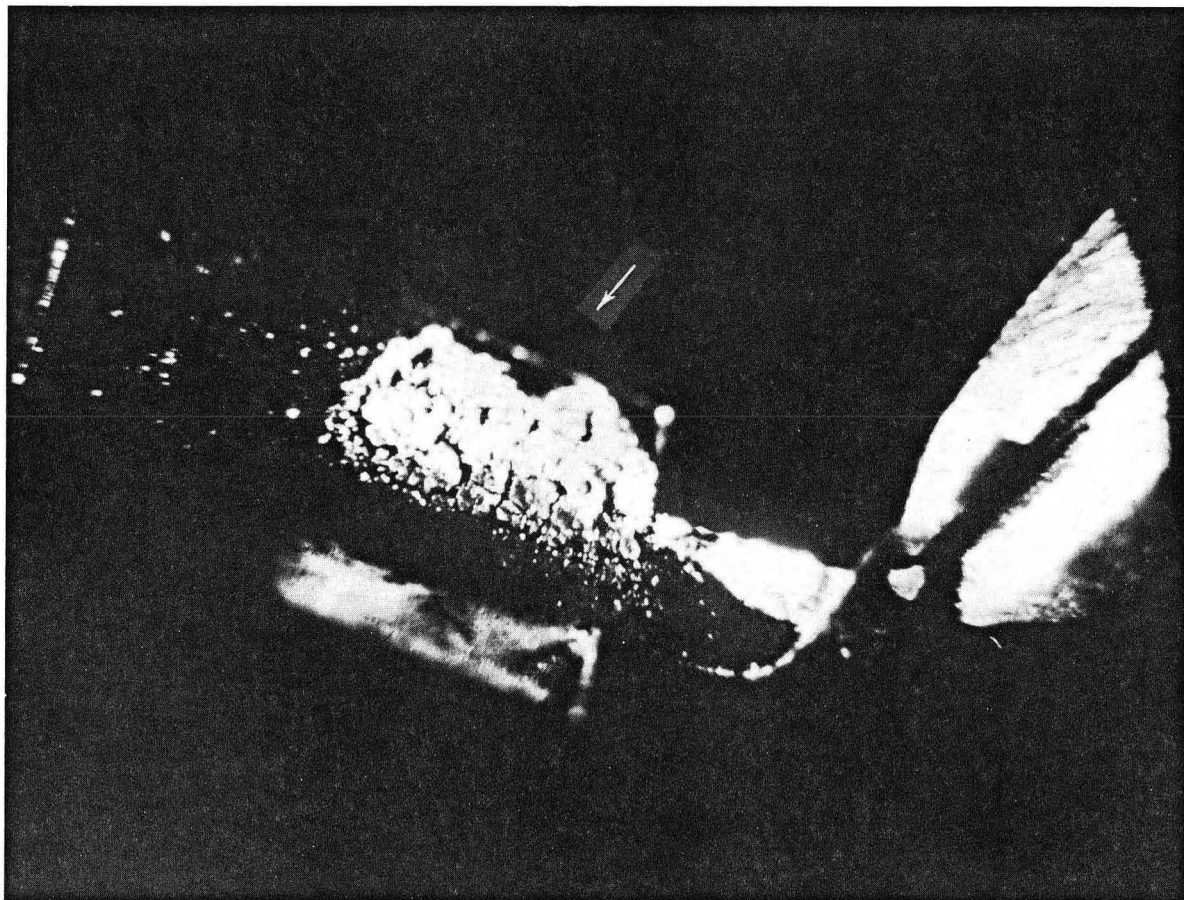

Fig. 15 Plutonium oxide (2.77 micrograms) weighed on September 10, 1942. It is shown on a platinum weighing boat magnified approximately 40-fold. The plutonium oxide appears as a crusty deposit (indicated by the arrow) near the end of the platinum weighing boat, which is held with forceps that grip a small handle (upper part of photograph). (CHEM 1146)

9/11/42

photographing this pure plutonium compound (see Figure 16). After this digression for the benefit of display purposes, the hydroxide was converted to the nitrate by solution in nitric acid and evaporation to dryness. An aqueous solution of this was placed on a weighed platinum boat, evaporated and ignited and found to weigh 4.45 micrograms, corresponding to 4.02 micrograms of plutonium on the more reasonable assumption that the formula of the oxide is PuO_2 . The oxide dissolved fairly readily in hot concentrated H_2SO_4 , presumably due to the formation of the stable soluble complex of Pu^{+4} with sulfate ion for which we have previous evidence. An alpha particle count on an aliquot of this indicates that the total alpha activity in the sample is 672,000 alpha disintegrations per minute. This corresponds to a specific activity of 167,000 alpha disintegrations per minute per microgram, which leads to a half-life value of $20,000 \pm 2,000$ years for 94^{239} .

In the original report on 94^{239} (G. T. Seaborg, E. Segrè, J. W. Kennedy and E. O. Lawrence, Report A-33, "Properties of 94^{239} "), the value for its half-life was given as 30,000 years. This determination was based on the ratio of the beta-disintegration rate of 2.3-day 93^{239} to the alpha-disintegration rate of its daughter 94^{239} without allowance for the large proportion of conversion electrons present in the decay of 93^{239} . In a more recent study ("Determination of the Half-Life of 94^{239} ," a report by Wahl and me that will be issued soon) another value of the half-life (23,000 years) has been determined, which should be more accurate. This determination is based on the measurement of the ratio of the 23-minute U^{239} beta-disintegration rate to the alpha-disintegration rate of its 94^{239} granddaughter with the assumption that no conversion electrons from U^{239} were measured in the experiments, which seems to be supported by the absorption measurements on the U^{239} radiation.

Most of our knowledge to date on the chemical properties of 94 has been based upon experiments in which tracer quantities were used, and usually the tracer isotope has been the 50-year 94. The 50-year 94 activity is formed in the deuteron bombardment of uranium, and its immediate parent is a 93 isotope of 2.0 days half-life. The isotopic assignment of the 50-year 94 activity has not been certain, and yield arguments (G. T. Seaborg,

9/11/42

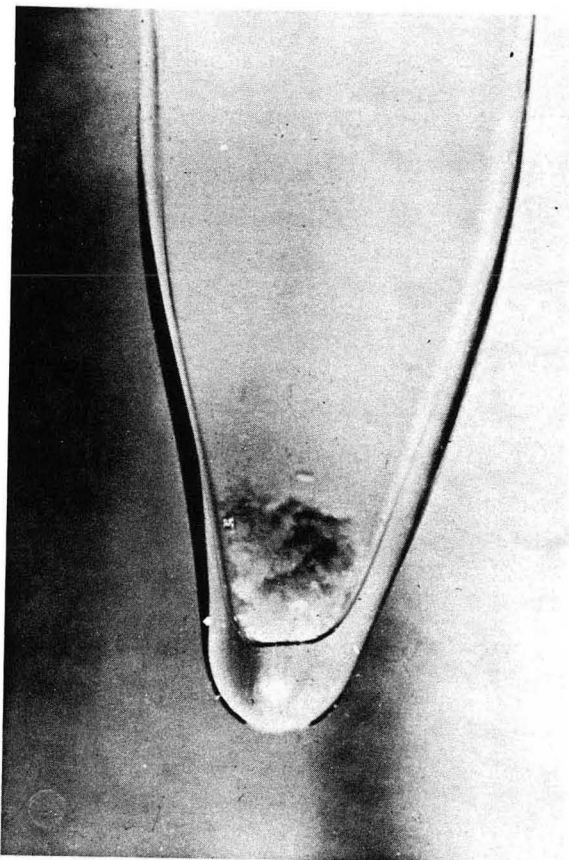

Fig. 16 Plutonium hydroxide (about 20 micrograms) isolated on September 11, 1942. It appears in the picture as a cloud-like mass of material at the base of the glass microcone (test tube). Magnification about 40-fold. Outer wall of test tube is indicated by black line from top of photo. The tube wall widens at the sides and forms a broad base. The circular spots (three white and one black) are imperfections and should not be confused with the cloud-like mass of 20 micrograms of pure plutonium hydroxide at the base inside the test tube. Above the plutonium compound is empty space. (CHEM 2515)

9/11/42

A. C. Wahl, J. W. Kennedy, Report A-136, "Production and Properties of 50-year 94") indicate that the activity should be assigned either to 94^{238} or to 94^{235} , formed from 2.0-day 93^{238} or 93^{235} , which in turn are formed in a $d,2n$ reaction. Subsequent experiments (J. W. Kennedy, M. L. Perlman, E. Segrè and A. C. Wahl, Report A-207, "Formation of 50-year 94 from Deuteron Bombardment of U^{238} ," have shown that the 14 Mev deuteron bombardment of separated U^{238} , of high isotopic purity, gives the 50-year 94 with the same yield as that obtained when the natural mixture of uranium isotopes is the target. This makes it practically certain that the 50-year 94 is to be assigned to 94^{238} . The only other alternative is an extremely improbable one, namely, that the 50-year 94 is isomeric with the long-lived 94^{239} , its 2.0-day 93 parent being formed from uranium in a d,n reaction. Now, the yield experiments of English, for which he finished his calculations today, make it certain that the 50-year 94 and its parent 2.0-day 93 are formed as the result of a $d,2n$ reaction; so it can be established that the isotopic assignment must be 94^{238} .

English's study, with the assistance of James, is based on the variation of yield with energy when deuterons impinge on uranium. Since the deuteron bombardment of uranium also forms the 2.3-day 93^{239} (and daughter 94^{239}) and since these isotopes are formed by either a d,p or d,n initial reaction or by both reactions on uranium, a basis for differentiation from the $d,2n$ reaction is available in the same deuteron-bombarded sample. The yield of the $d,2n$ reaction would vary differently with deuteron energy from that of the d,p or d,n reaction, the $d,2n$ reaction having a higher energy threshold and the yield increasing more rapidly with deuteron energy in the energy region investigated.

Bombardments of thick uranium metal targets have now been made with 14 Mev deuterons at Berkeley, 12 Mev deuterons at St. Louis and 8 Mev deuterons at Chicago. The chemical separations on the uranium bombarded at Chicago were made by English and James in the usual manner, with the oxidation-reduction cycles repeated several times to insure clean separations of 93 and 94. The yields were determined with calibrated beta- and alpha-particle measuring instruments and were corrected back to the time at the end of the short bombardments. The 93 yields (mainly 93^{239}) in millicuries per 1,000 microampere-hours for deuteron energies of 14 Mev (Berkeley), 12 Mev (St. Louis) and 8 Mev (Chicago) are, respectively,

9/11/42

90, 60 and 0.04. The 94 (50-year) yields in microcuries per 1,000 microampere-hours for the same deuteron energies are, respectively, 0.89, 0.13 and $<10^{-5}$.

It is apparent that, although there is a factor of approximately seven between the yields of 50-year 94 with 14 and 12 Mev deuterons, the 93^{239} yields are nearly equal. There is 1,500 times as much 93^{239} formed with 12 Mev deuterons as with 8 Mev deuterons, whereas the corresponding ratio of 50-year 94 yields is more than 10 times as great. (There was no discernible yield of 50-year 94 in the 8 Mev bombardment, which had an intensity of about 300 microampere hours.) It appears certain, therefore, that the 50-year 94 yields is produced as a result of a different initial reaction from that which results in the production of the 93^{239} and 94^{239} and must be produced in a $d,2n$ reaction, agreeing with the assignment of 50-year 94 to 94^{238} .

The S-1 Executive Committee, composed of Conant, who is Chairman, Murphree, who is Vice-Chairman; Briggs, Compton, Lawrence and Urey will meet in California Sunday and Monday to make some big decisions, including the future locations of pile No. 1 and pile No. 2 and the chemical separation plant. There was a preliminary meeting here today, with all members present except Lawrence. One of their objectives in coming here was to inspect the Cook County Argonne Forest Preserve as a possible site for the pilot pile plant. I was invited to accompany them and give my advice if needed.

When we arrived, we were able to take a new access road leading into the property from State Highway 4A, also known as Archer Avenue. Much surveying, grading and the taking of soil samples were going on. Building materials were being brought in and the construction of the pile building looked impending. Conant was not impressed with the location because of its proximity to downtown Chicago, which is roughly twenty miles away. He is of the opinion that the pilot plant should be built in Tennessee. Indeed, he and Compton suggested that I go to the Tennessee Valley myself in another week or so and inspect the proposed site as a possibility for the 94^{239} chemical separation plant.

9/11/42

After yesterday's news, it is a relief to read that the Allies have checked the Japanese drive on Port Moresby.

Saturday, September 12, 1942

On Thursday I received a note from Gofman saying that he would appreciate receiving a uniform sample of 94^{239} from us, as I offered in my letter of September 2. He said that any sample more than five micrograms might interfere with the proper amplifier operation and asked that we keep it to four micrograms or less. Today I replied that we are sending him a sample of pure 94 iodate, which was prepared by evaporating a water suspension of the iodate on a platinum sheet, and then gluing the sheet to a copper disc with Glyptal cement. As a precaution against flaking, the platinum sheet was covered by a copper dish. I gave a few directions about handling it. Gofman has been writing up his work on U^{232} , and I requested that he send it to me fairly soon. I also advised him to write a report on the slow neutron fission of U^{234} as soon as possible.

I also notified Gofman of the S-1 Executive Committee's visit to Berkeley. I said, "Although the primary purpose of their visit is in connection with Doctor Lawrence's project, some of them may come over to visit you people in Gilman Hall. All of these men are probably eligible to learn about everything you are doing; but if you are ever in doubt as to what to tell them, you might contact Dr. Compton. Compton, of course, is eligible to know everything, and I had some rather long discussions here with him about the work; he is very interested in the chemical properties of 94. I am counting on you people to make it clear that you are taking adequate precautions with regard to secrecy requirements, and I am sure that you will make a good impression scientifically. The possibility exists, of course, that these men may not find time to have much discussion with Latimer's group."

After posting my letter to Gofman, I received information from him and Duffield on their measurements of the slow neutron fission cross section of U^{234} using the older 1.6 microgram sample; they haven't started to use

9/12/42

the newer, thinner, one-microgram sample. It was isolated as part of the Berkeley program of extracting UX_1 from UNH. The UX_1 was combined from a number of extractions, allowed to decay to U^{234} , and this was then separated and electroplated onto platinum. In their measurements the slow neutron induced fission rate of this U^{234} was compared with that of a 1.4 microgram sample of U^{234} (in 200 micrograms of ordinary uranium) using the Berkeley one-gram Ra-Be neutron source. Their results indicate that U^{234} does not undergo fission with slow neutrons. The U^{234} sample did exhibit a very small but definite slow neutron induced fission rate, a few percent of that of U^{235} , but this is probably to be ascribed to the presence of some ordinary uranium impurity in the U^{235} sample.

Kamen, in reply to my last Monday's query about the bombardment of our samples in the 60-inch cyclotron, said that the samples have received the equivalent of 3,000 microampere-hours of irradiation. "The cyclotron," he wrote, "has been adorned with festoons of various samples contributed by hopeful customers, but your sample is in a preferred spot and may be more active than you might infer from my estimate. You know me—I always prefer to look at things with a jaundiced eye. Regards to Helen and all."

From the Russian front comes the good word that the Soviets have stopped the German drive on Stalingrad.

Sunday, September 13, 1942

Working in our apartment this afternoon, I dictated to Helen a memorandum on the possible U^{233} in our project, something that has been on my mind for some time. I have the feeling that insufficient attention is being given to the potential of this isotope as a back-up product should the nuclear properties of 94^{239} and U^{235} be deficient in some respect. I feel that if I prepare and circulate a memorandum pointing out this possibility it will attract the required attention. In my memorandum I describe the production of U^{233} by the slow neutron bombardment of Th^{232} and also review its radioactive and fission properties. I point out that

9/13/42

the U^{233} will have to be produced in conjunction with a chain-reacting pile operating on uranium and that the intensity of fission products can be kept relatively low because Th^{232} is not fissionable with slow neutrons. I also describe a number of possible methods for the chemical separation of U^{233} from the large masses of thorium, including the volatility process in which the volatile uranium hexafluoride is separated, the peroxide process in which the thorium and uranium are precipitated as peroxides with the subsequent separation of uranium by dissolving its peroxide in sodium hydroxide solution, and the fluoride method in which the thorium is precipitated as the fluoride leaving the soluble uranyl in solution. I emphasize that we have worked on all of these methods and that our research program on extraction processes for the separation of 94^{239} from neutron-bombarded uranium also gives us a background of relevant experience.

Perlman and I left around midnight on the train to St. Louis.

Monday, September 14, 1942

Perlman and I arrived in St. Louis at 7:20 a.m. and spent the day at Washington University conferring with Alex Langsdorf and others on the arrangements for our forthcoming neutron bombardments of large amounts of UNH to produce 94^{239} in quantity for our microchemists and for other parts of our research program.

Cunningham, Cefola and Werner are continuing their work with 94^{239} and so far have prepared plutonous nitrate, plutonous oxide, plutonous hydroxide, plutonous iodate, plutonous fluoride and plutonous peroxide. They expect to investigate further the properties of these compounds in the near future.

Today Cefola started to work with Jaffey's final concentrate of batch no. 3 of the St. Louis neutron bombardment, containing about 7×10^6 alpha disintegrations per minute of 94^{239} in a volume of 12 cc, with the aim of

9/14/42

isolating pure 94^{239} through the application of oxidation-reduction cycles and carrying by rare earth fluoride.

Our report "Determination of the Half-Life of 94^{239} " by Wahl and me is being issued as Report CN-266. This describes two experiments at Berkeley last year in which the half-life of 94^{239} was related to that of the 23.2-minute U^{239} through observation on the $U^{239} \xrightarrow{23.2m} 93^{239} \xrightarrow{2.33d} 94^{239}$ decay chain. Because of the presence of conversion electrons in the beta radiation of 93^{239} , it is necessary to relate to U^{239} which apparently emits no conversion electrons in its decay process. Relating the intensity of the U^{239} beta radiation (samples, U,n-11-1 and U,n-12-1), with the help of the measurements on intermediate 93^{239} (samples 93-19-1 and U,n-6-1), to the intensity of the 94^{239} alpha particles, we can calculate from the known half-life of U^{239} (23.2 minutes) the half-life for the 94^{239} . Our two experiments give values of 2.0×10^4 years and 2.5×10^4 years, for an average value of 2.3×10^4 years which, along with the value determined by Cunningham and Werner last Friday (20,000 years), should be a better value for the half-life of 94^{239} than the 3×10^4 years now in current use.

Tuesday, September 15, 1942

Perlman and I returned by train from St. Louis around 7:00 this morning.

English and James have been working on a project to make another determination of the half-life of 94^{239} through measurements on the $93^{239} \rightarrow 94^{239}$ decay chain as has been done by Wahl in Berkeley. James has extracted the 93^{239} from some of the UNH bombarded with neutrons at the cyclotron of Washington University in St. Louis by our well-established oxidation-reduction cycles using rare earth fluoride as carrier. James finished his isolation of the 93^{239} fraction from the most recently neutron-bombarded UNH at 8:00 p.m. this evening; i.e., this is the time of the final separation of the daughter 94^{239} from the 93^{239} and represents the zero time for growth of daughter 94^{239} in this sample of

9/15/42

93^{239} . He dissolved the final 93^{239} fraction and made up a total volume of 100.0 cc and put this aside for decay to daughter 94^{239} . The plan is for English to determine the intensity of 93^{239} beta particles in this solution by measuring a number of aliquot samples; and, after the total decay of the 93^{239} , he will isolate aliquot samples of daughter 94^{239} to determine their alpha particle activity.

Koshland and Magel have completed an experiment as part of their study of separating element 94 from uranium and the fission products by the solvent partition method. In their experiments with neutron-bombarded UNH, using material from the large bombardment at St. Louis, they have used the 94^{239} and fission products as tracers for these elements. In a typical experiment the UNH was melted to give an aqueous solution and the 94 was oxidized to its higher oxidation state by the addition of dichromate ion and nitric acid. After cooling, this solution was extracted with diethyl ether, as a result of which they found about 90% of the 94 and only about 1% of the fission products in the ether layer when aliquot samples were isolated for alpha counting (to detect 94^{239}) and beta and gamma counting (to detect fission products). The ether layer, which contains about 90% of the uranium, then was shaken with two small portions of water saturated with SO_2 in order to reduce and extract the 94. These combined aqueous layers, which now have only a small fraction of the original uranium, contained the 90% of the 94 and the 1% of the fission products. The significance of these experiments is that the uranyl nitrate itself can act as the "salting out" agent making it unnecessary to use another salt such as $LiNO_3$ as was used in earlier experiments.

Covey and his helpers are busy in the attic and on the roof recrystallizing Mallinckrodt UNH for use in our next St. Louis neutron bombardment. This operation has been perfected to the point where it no longer needs to be carried out by our chemists. This is being done in large pots on the roof area of Jones Laboratory adjoining the "attic" (Figure 17).

Laitinen of the University of Illinois informed me by letter that their first local University of Illinois Section meeting of the American

9/15/42

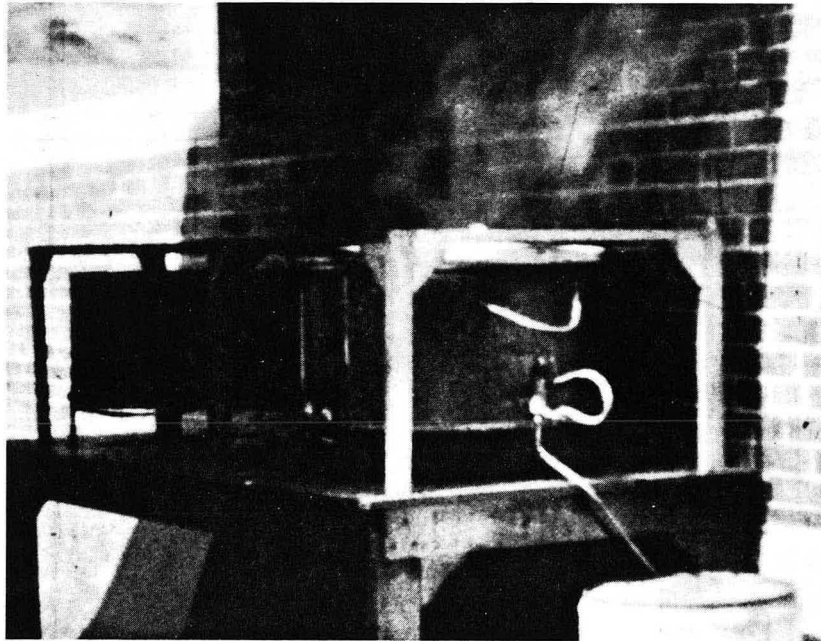

Fig. 17 Recrystallization of UNH in pot on roof area of Jones Laboratory. (XBB 768-7459)

9/15/42.

Chemical Society has been set for 7:30 p.m. on Thursday, October 1. He inquired if this time will be satisfactory for the presentation of my talk. A small informal dinner has been planned before the meeting and I will be escorted there from the train station.

Stan Thompson sent a letter from Berkeley saying that Moulton has now made him a formal offer of employment with my group, but that his company, Standard Oil, has not yet consented to giving him a leave of absence.

The Research Associates of my group met with me in my office this evening. We talked about the assignment of the chemical engineers R. S. Apple to work with Perlman and Knox and D. S. Webster to work with Brown and Hill. We discussed the Perlman-Goldschmidt write-up on their survey of long-lived fission products in order to determine whether this should be published as a Project Report. Cunningham's report on this weighing of plutonium oxide and observation of a number of compounds of pure 94 was of especial interest to the group.

Wednesday, September 16, 1942

English has spent the last several weeks working with Ghiorso on improving the ionization chambers and attendant apparatus for counting alpha particles. He has devoted time to the "low geometry" ionization chamber, which is being set up for the direct counting of samples with high alpha emission rates and with the help of James has been calibrating a number of screens which are used to further reduce the alpha counting rate on high intensity samples by interposing them between the sample and the screen-windowed ionization chamber. They have been using standard polonium alpha sources for these calibrations and have calibrated three screens which transmit 28.0%, 7.2% and 2.0% of the alpha particles.

We are now reporting the progress of my C-V Group and the Berkeley group, Chemistry of 94, on a bi-weekly basis, and the Report for September 1-15, 1942 (No. CN-261), was completed today. In this report I summarize the work of each group and am fortunate in being able to include a

9/16/42

reproduction of a photomicrograph made by Covey and the ultramicrochemists of 0.5 microgram of pure plutonium hydroxide.

In summary the report says: English and James have determined that the isotopic assignment of 50-year 94 is 94^{238} , by conducting experiments involving bombardment of uranium targets with deuterons of different energies which show that the 50-year 94 is formed as a result of the $d,2n$ reaction. Cunningham, Cefola and Werner have purified additional amounts of 94^{239} and have prepared and investigated the properties of plutonous nitrate, plutonous oxide, plutonous iodate, plutonous hydroxide, plutonous fluoride and plutonous peroxide. They have also performed an independent determination of the half-life of 94^{239} by measuring the alpha activity of 4.45 micrograms of PuO_2 which has been weighed on the Salvioni balance; the figures obtained correspond to a half-life of $20,000 \pm 2,000$ years. Brown and Hill have studied the volatility of uranium and 94 fluorides as a function of temperature and find that for 94 the onset of volatility is about $320^\circ C$, with volatilization at $520^\circ C$; the corresponding figures for uranium are $150^\circ C$ and $270^\circ C$. Preliminary experiments have also been conducted which show that either the volatile fluoride of 94 is not formed at temperatures below $320^\circ C$ or that it decomposes if heated in an atmosphere other than fluorine. In other experiments it has been shown that U_3O_8 can be rapidly reduced by hydrogen to UO_2 . Willard and Turk have performed additional experiments on the adsorption method for separating 94 using Hyflo Super Cel and find that (1) observations made on the adsorption of tracer quantities of an element may be indicative of the efficiency of adsorption of the same element from solutions of concentration equivalent to that of 94^{239} in the material from the experimental pile, (2) adsorbed fission products are concentrated most strongly at the top of an HSC column, (3) the efficiency of an HSC column in adsorbing 94 decreases continuously as the volume of uranyl nitrate- 94^{238} solution which has passed through is increased, and (4) two of the fission products which are adsorbed on HSC from 10% uranyl nitrate solution are zirconium and columbium. Koshland and Magel have performed experiments which show that, in the presence of a high concentration of uranyl nitrate in the aqueous phase, the oxidized state of 94 passes nearly quantitatively into the ether phase with only 1% of the fission products, thus indicating that the solvent partition method for extracting 94 offers good hope as a separation process. In the Berkeley

9/16/42

part of the report, Garner and Gofman report on "Oxidation Reactions of 94 (²³⁸U)," Garner on "Volatility of 94 Compounds" (in which he reports that 94 oxide does not volatilize from molten Na₂O₂ in an oxygen atmosphere at 500°C), Connick and Gofman on "Transference Experiments with 94 and 93," Duffield on "Precipitation Reactions of 94 and 93," and Hamaker on "Reduction and Oxidation Reactions of 94 and 93."

Compton has returned from California, where he and the other members of the S-1 Executive Committee, Conant, Murphree, Briggs, Lawrence and Urey, held a meeting on Sunday and Monday at Berkeley and the Bohemian Grove, near San Francisco. Others present were Oppenheimer, Cooksey and R. L. Thornton (who are associated with Lawrence's project) as advisers from the University of California, and Colonel Nichols and Major Crenshaw.

On the basis of their visit to the Argonne Forest Preserve last Friday, September 11, and a full discussion afterwards (Conant told Compton, "You are after elephants with a pea-shooter."), the Committee voted to abandon plans to erect pile No. 2 in Palos Park and to set it up instead in the Tennessee Valley at the earliest possible moment. As for pile No. 1, it is to be moved from the Stands at the campus to the Argonne Forest next month, after it has been used to demonstrate the nuclear chain reaction. It was the understanding in accordance with this vote that (1) the development of chemical engineering equipment to handle the separation of material from pile No. 2 to be erected in the Tennessee Valley, is to proceed at once, and (2) the Met Lab will operate pile No. 1 in order to obtain evidence of a self-sustaining chain reaction as measured not only by observation of neutrons but also in one instance by allowing the temperature to rise, thus demonstrating the development of power.

A second vote was taken to recommend strongly to the Army that Stone and Webster enter into a subcontract with a chemical company for the development and operation of the chemical engineering equipment needed for the separation of 94 from the pile material. Companies suggested were Dow Chemical Company of Midland, Michigan, Monsanto Chemical Company of St. Louis and Tennessee Eastman Company of Memphis. It was felt that unless a subcontractor is used, there will be serious delays in the development of the chemical engineering operation. Furthermore, a subcontractor would already have a large staff of experienced chemical engineers.

9/17/42

The Committee, after having visited the Radiation Laboratory at Berkeley and seeing work in progress on the electromagnetic process for separating U^{235} , voted to recommend to the Army that commitments be now entered into for the construction of a 100-gram per day U^{235} electromagnetic separation plant, such a plant to be erected on the Tennessee Valley site. It was estimated that this plant will consist of between 100 and 400 calutron units and cost approximately \$30,000,000.

A careful consideration was given to the importance of the production of heavy water at Trail in Canada. After discussion it was voted to notify the Army it is the Committee's opinion that construction of the plant should be completed by May 1 of next year, it being of utmost importance that this date be met, whatever priorities might be required.

I assured Laitinen by letter that the October 1 date for my talk at the American Chemical Society is satisfactory for me. By taking the Panama Limited, I expect to arrive in Urbana at 5:20 p.m., which will fit in with his plan to have me to dinner.

Official announcement comes today that there will be oil rationing in 30 states.

Thursday, September 17, 1942

Knox and Perlman are working with Apple, one of the du Pont chemical engineers assigned to our program. They are considering, in cooperation with the chemical engineers, the equipment problems attendant with the large-scale operation of the "wet fluoride method" for the extraction of 94 from uranium and fission products in neutron bombarded uranium. They are considering such questions as equipment and chemical reagents, operating procedure and safety factors. In this connection they are beginning experiments using 94^{239} to help determine the choice of oxidizing agent, the minimum time and temperature required for the oxidizing step, the choice of reducing agent, the minimum time and for the reducing step, the effect of air agitation on the completeness of reduction and the degree of precipitation of 94 on a preformed LaF_3 precipitate. They use the usual

9/17/42

methods of testing for the upper oxidation state (observation that the 94 doesn't precipitate with LaF_3) and for the lower oxidation state (observation that 94 does precipitate with LaF_3).

Black news today from the Soviet front--the Nazis have rammed their way into the outskirts of Stalingrad.

Friday, September 18, 1942

Willard and Turk have completed experiments to determine the behavior of 94 and 93 in their low oxidation state in solutions of 8-hydroxyquinoline (oxine). The experiments were carried out by adding in excess of 2% solution of oxine in acetic acid to dilute UNH solutions containing 94^{238} and 93^{239} in tracer quantities. Solid uranyl quinolate precipitates and their results indicate that 94 is carried quantitatively at pH's above 3.2, while the 93 is not carried. The purpose of these experiments is to try to determine whether an organic precipitant might be useful for the separation of 94 from uranium and fission products in neutron-irradiated uranium from the pile.

Completing an experiment started yesterday, Perlman, Knox and Apple demonstrated that $0.1 \text{ N Cr}_2\text{O}_7^{-2}$ in 0.5 M HNO_3 and 10% UNH solution oxidizes 94 completely when the reaction takes place for 15 minutes at 95°C . They then demonstrated that H_2O_2 will reduce the 94 completely when a solution is held at 50°C for one hour.

I took the information received from Duffield and Gofman last Saturday and prepared a report entitled "Test for Slow Neutron Fission of U^{234} ," which is being issued as Report No. CF-272 under the authorship of Gofman, Duffield and me. In this we report that U^{234} apparently does not undergo fission with slow neutrons and that the small slow neutron induced fission rate observed in our 1.6 microgram U^{234} sample is probably due to the presence of a few micrograms of ordinary uranium impurity.

9/18/42 .

My other report, "Proposal for the Production and Use of U²³³," which I dictated to Helen last Sunday, is being issued as Report CF-268.

A Western Union message delivered to my office pleased me in the extreme. It was from my friend, Stan Thompson, saying that he now has a leave of absence from his company and will arrive in Chicago on October 2.

Heydenburg's letter dated September 2 was answered with a promise to send him ten micrograms of 94²³⁹, within a few weeks when we finish isolating it. I explained that the sample will be in the form of an essentially pure compound of 94, without any carrier material. In view of the fact that this small sample must be spread over the 11-mm diameter platinum foil, it will be difficult to give it a uniform distribution over the area. I asked Heydenburg to advise me about his requirements.

Goldschmidt and Perlman (Figure 18) completed their research on long-lived fission products. Although initially I had asked them for a write-up to be used internally in our group, their investigations proved so thorough and tremendously important that I decided, with the concurrence of Allison, to issue it as a Project report. So today it is available in manuscript form to come out as Report CC-295 under the title, "Survey of Long-Lived Fission Products," authored by B. L. Goldschmidt and I. Perlman. Noteworthy is the fact that they discovered and reported on moderately long-lived radioisotopes of columbium, zirconium and ruthenium, hitherto unobserved in slow neutron-induced fission. This information is of enormous importance to our program of devising procedures for the separation of 94 from uranium and fission products. The paper is divided into four parts and is accompanied by eight related tables.

The four parts are entitled, I. Introduction; II. Procedures for Isolation of Individual Elements from Fission Product Mixtures; III. Procedure for Complete Chemical Analysis of Long-Lived Fission Products Using a Single Sample; and IV. Relative Yields and Radioactive Characteristics of Long-Lived Fission Products. Under part II, the following chemical elements are discussed in their own section: A. Xenon; B. Cesium and rubidium; C. Barium (44-hour lanthanum); D. Strontium and barium; E. Zirconium and columbium; F. Iodine; G. Tellurium, antimony,

9/18/42

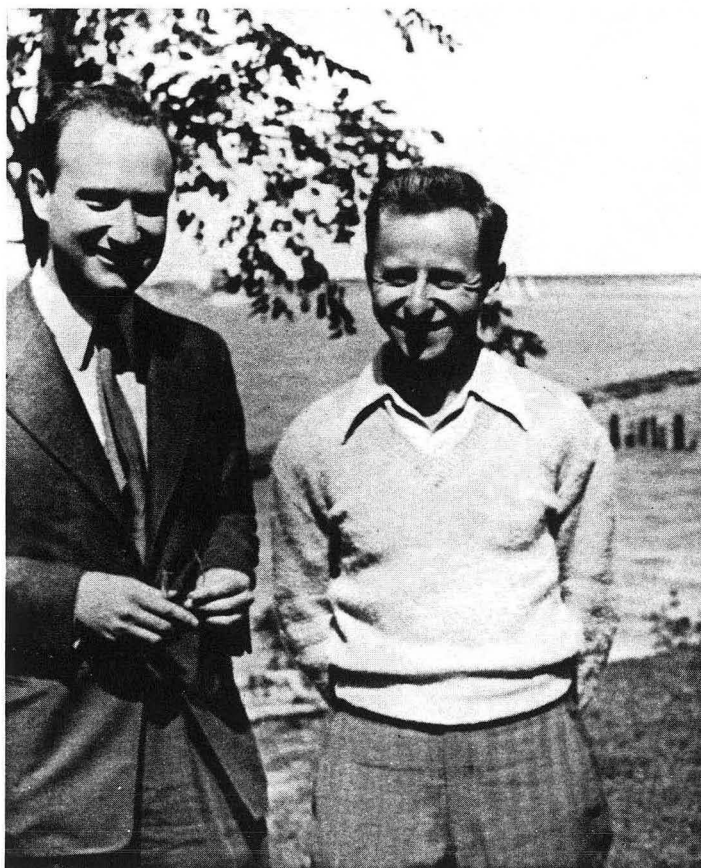

Fig. 18 Bertrand Goldschmidt and Isadore Perlman, fall 1942, Lake Michigan. (XBB 761-850)

9/18/42

molybdenum, 43 and ruthenium; H. Tellurium; I. Molybdenum; J. Antimony; K. Ruthenium and 43; and L. Lanthanum, yttrium and cerium. Under part IV there are separate discussions of the chemical and radioactive characteristics of cesium, barium, lanthanum (44-hour), strontium, zirconium, columbium, yttrium, cerium, tellurium, iodine, ruthenium and molybdenum-antimony-43. Part IV also includes, with tables, results on relative yields as a function of time after the end of a bombardment and energies of the radiations associated with long-lived fission products.

At 4:30 p.m. Helen and I, and some of our friends, attended the wedding of Spof English and Muriel Kathryn Frodin in the Thorndike Hilton Chapel on the campus of the University of Chicago.

There was a meeting of the Technical Council (a reconstituted group replacing the Planning Board) attended by Allison, Compton, Fermi, Moore, Spedding, Szilard and Wheeler. After a discussion on the production and procurement of materials, such as magnesium, calcium, graphite, uranium metal and so on, and after Spedding left the meeting, talk continued at great length concerning the role of the Met Lab at the new site in the Tennessee Valley, which for the sake of security, is being called "Site X."

Compton confided in the group that he was disappointed that Colonel Marshall had not selected the site a month ago, as the Army had previously considered it. The environs of Mt. Shasta had also been considered as a possibility but lost out in favor of Tennessee because of the Mt. Shasta region's inadequate power supply. Colonel Kenneth D. Nichols is now getting condemnation proceedings against the farmers who occupy land at Site X, and we should expect new buildings there by January of next year. Compton said that he agreed with Steinbach and Captain Grafton yesterday to go ahead at Site X with those buildings previously planned for the Argonne Forest site, i.e, triple chemical extraction plant, shops, water supply, engineering laboratory with space for a health group -- all of which are associated with the pile production unit as well. He went on to say that Lawrence's experiments at Berkeley are at the stage in which U^{235} can be produced in 40-fold concentration, that his pilot plant is designed so much like a production plant that it permits

9/18/42

indefinite expansion. As for Urey, he will transfer the centrifuge problem to Site X at a later date, but not now.

Fermi wondered whether the Met Lab research could be organized under an independent corporation, which led into a discussion of the role of private corporations versus government-owned corporations in controlling the whole nuclear energy program. Compton has suggested to Colonel Marshall that Union Carbide, Stone and Webster, du Pont, and Standard Oil are the best firms for our purpose. Wheeler observed that we should be concerned about what will happen in the next twenty years, rather than in just the first five years, and, to avoid having some arbitrary executive arrangement, final authority should be vested in the U.S. Congress or the United Nations. Another possibility suggested was the National Academy of Sciences.

After some controversy about possible advantages of having an experimental laboratory at Argonne Forest rather than at Site X, Wheeler thought that if we are to produce the necessary quantity of material (the order of 500 kg) by fall of 1945 or spring of 1946, then a sizable laboratory will be necessary for the work at Site X. Compton replied that a decision is not possible now, but that Briggs will be here tomorrow, followed by Murphree, Urey and Conant later to settle such matters. Wheeler's response was that the problem is really how much material has to be produced, and Compton said that Bush has proposed another committee to determine how material is to be used in the design and production of bombs.

Wheeler asked when a decision will be made on the building of the pile production plant; and if a decision is not forthcoming until after a chain reaction is achieved, say February 1, then engineers should have time to work on schemes for cooling a working pile that is an alternative to cooling by helium. Fermi agreed with him and thought that we should be prepared to switch to a completely water-cooled plant if that is indicated. This conversation about water cooling led into a debate about the work in my group. It came about this way: In order to give the chemical engineers something to work on, according to Compton, a water-cooled pile could be assembled in January or February, with delivery of 94^{239} to the

9/18/42

chemical engineers by April or May. Then Fermi wanted to know whether this need is vital and whether it is only based on a suspicion that there might be a difference between tracer behavior and bulk chemistry. Allison spoke up in my behalf and assured him that I feel it is necessary to check results of tracer work with microchemical experiments because there can be important differences between tracer and bulk chemistry. When Compton said that what he really has in mind about the chemical engineers is that he foresees there will be problems with hazardous radiations and mechanical handling devices, Fermi had the good grace to withdraw his objections.

The remainder of the meeting was related to administration, such as who will administrate the Site X project. Allison proposed that he himself, being a physicist, should be replaced by a new director of the Chemical Division who can inspire and stimulate the staff chemists. Szilard suggested W. K. Lewis as a candidate, and Moore responded that he already has several jobs, including development of methods to make explosives.

Saturday, September 19, 1942

Several Metallurgical Project Reports for the month ending September 15, 1942, became available today. Steinbach reports that construction of the pile No. 2 building in the Argonne Forest Preserve is under way, and it is hoped to be sufficiently completed by October 12 — only a month away — to permit the assembly of pile No. 2. (Events of the last few days have overtaken this plan — pile No. 2 is now scheduled to be built at Site X.)

Steinbach also says that good progress is being made on the construction at Argonne of the laboratory for experimental purposes, and that it should be completed by October 1. Contracts for laboratory benches and work tables and the various services have been negotiated. The actual transfer of working groups into the new building may not begin until after the middle of the month.

Moore and Leverett each report on the status of the 100,000 kw helium-cooled pile. During the past month, most of the equipment necessary for

9/19/42

certain tests on the operation of the pile has been assembled in the North Stands. The principal features of such a pile have been worked out and are the subject of a report to be issued within the next few days.

The design calls for circulation of helium by compressors at a pressure level of approximately seven atmospheres. The heat is to be removed from the gas by heat exchangers through which water circulates. Although the helium-cooled system has reached the stage described, alternative plans of removing heat from a nuclear power plant have been under study. These schemes are cooling by water, by liquid bismuth, by graphite powder, by wet helium and by uranium metal shot. Of all the alternatives, the water-cooling system has received the most thorough study short of preparation of an actual engineering design.

It is also reported that an exceptionally well qualified group has been set up under the direction of Dr. Robert S. Stone, who has been associated with the 60-inch cyclotron at Berkeley, to deal exclusively with problems of radiation and protection of personnel. Stone will now divide his time between Berkeley and Chicago.

Manley reports on fast neutron work at Chicago and affiliated laboratories. Some of the investigations being carried on are as follows: Segrè and Kennedy (Berkeley), radiative capture and thermal fission cross sections; Manley (Chicago), fast fission and fast fission detection; R. F. Bacher (Cornell), delayed neutrons, fast neutron detection; fission spectrum, and energy dependence of slow neutron fission; J. H. Williams (Minnesota), scattering cross section of deuterium; H. A. Wilson, W. E. Bennett and H. T. Richards (Rice), fission energy spectrum; F. Bloch (Stanford), no report; J. L. McKibben (Wisconsin), scattering, fission cross sections and fast neutron detection; and N. P. Heydenburg (Washington DTM), isotopic assignment of fissions.

One section of the report states that any remaining doubts about the accuracy of the exponential pile as a means to measure the multiplication factor of a uranium carbon lattice have been dispelled by experiments carried out during the past month on a pile of size considerably larger than any on which measurements have previously been made. The multiplication factor for the best available uranium oxide has been found to be 1.012. Improved graphite and the exhaustion of the nitrogen from the pile is estimated to be capable of raising the multiplication factor to 1.03 or

9/19/42

1.04. Still further improvements should result when the oxide is replaced by uranium metal.

One paragraph in particular of the report bears quoting: "Removal of the 94 produced in either a pilot power plant or a full scale neutron multiplier will present large scale problems of chemical engineering. Methods for handling these problems are well in hand. The chemical properties of element 94 have been studied in considerable detail. The most dramatic moment in this study came on the afternoon of Thursday, August 20, 1942, when a minute speck of white fluoride of 94 was seen for the first time. The chemical methods developed on a small scale in these investigations are now being translated into intermediate and large scale operations of a chemical separation plant."

The report goes on to say, "The possibility that the first attack from Germany, if one comes, would come in the form of radioactive fission products rather than in the form of fissionable material has led to the study of possible counter measures against such radioactive materials. In case an air raid is made on any city of the United States, plans have been made so that a cooperating scientist nearest the city attacked will go immediately to the site, taking with him a sufficient number of instruments and co-workers to make a radioactive survey of the bombed areas."

Experiments today by Perlman, Knox and Apple indicate that 94 is completely oxidized by 0.1 N $\text{Cr}_2\text{O}_7^{-2}$ in 0.5 M HNO_3 and 10% UNH solution in 30 minutes at 80°C.

I was glad to receive a letter from Stoughton today, but the contents were somewhat disturbing. His draft board in Bryan, Texas, referred him to Berkeley Local Board #70 for a physical examination, which he took last Wednesday night. It was announced during the exam that all who passed would be reclassified into 1A within ten days and then be inducted thereafter. Hamaker, he said, who had a similar experience a week earlier, received a notice on Thursday, the day the letter was mailed, that his draft board is going to leave him in 2A status until November 21, at which time it will consider his case for another six month's deferment.

9/19/42

Helen and I left today for my visit to Site X and a week-long vacation for us in the Smoky Mountains of Tennessee. Our farewell was marred somewhat by the following incident: Coryell and his group have had a chance to read the Goldschmidt-Perlman manuscript "Survey of Long-Lived Fission Products" and sleep on it; apparently they are very upset because Coryell asked for a meeting this morning to vent their displeasure. The meeting was attended by Allison, Coryell, Goldschmidt, Perlman, Spedding and me. Coryell's complaint was that we have skimmed off the cream of the investigations they are planning to do. We defended ourselves by saying that we haven't set ourselves up as rivals — we need the information in order to devise a chemical separation process for 94 on a time scale to be useful to the chemical engineers. The meeting was stormy, and Spedding, who is Coryell's supervisor, read his newspaper throughout. But he also grumbled and finally said, "If Seaborg minded his own business, such disagreeable incidents would never occur."

Later, Helen and I took a train to Cincinnati, where in the evening we changed to another train for Knoxville, Tennessee. Gatlinburg (and the Smokies) is only a short but scenic bus ride from there.

Sunday, September 20, 1942

Helen and I arrived in Knoxville and immediately transferred to a Greyhound bus that took us over a winding road up into the Great Smoky Mountains to a tiny village called Gatlinburg. We were amazed to find two modern tourist hotels here, the Greystone and the Mountain View, with broad expanses of lawn. We checked into Room 211 of the latter, where we had a reservation. The standard fare in the dining room, we learned, is southern fried chicken, mashed potatoes and gravy, hot biscuits, and an assortment of honeys made from local wildflowers. The few gift shops in the village specialize in local products, such as pottery, chenille bedspreads, hand weaving and maple furniture. In contrast there is a general store, Oglethorpe's, the typical cracker-barrel variety that caters to the farmers and sells such items as sunbonnets and kerosene lamps. We were told that a road was put through Gatlinburg only thirty years ago, and

9/20/42

that this store at one time traded with Indians who came from the Cherokee village about sixty miles away on the other side of the mountain.

Monday, September 21, 1942

Our first venture out of Gatlinburg was to take a hike to Cherokee Orchard. We are most fortunate to be taking our vacation at this time of the year because of the fall colors.

Tuesday, September 22, 1942

Helen and I took a long hike into the back country where we saw a number of mountain people and their picturesque cabins. They speak an unusual dialect, reputed to be unchanged from that used by the pioneer stock of the 1700's.

Wednesday, September 23, 1942

Helen and I left Gatlinburg for a hike to the top of Mt. Le Conte, on the way eating a bag lunch put up by the hotel. Tonight we had dinner at the Lodge of Mt. Le Conte and spent the extremely cold night there. Dinner was prepared from canned goods, in contrast to the delicious fare of the Mountain View Inn.

Thursday, September 24, 1942

After eating a hearty breakfast at the Lodge we hiked to Newfound Gap with another couple and rode with them from the Gap to the Mountain View Hotel.

Friday, September 25, 1942

The hotel put through a long distance call for me to Chicago and I talked to Iz about laboratory matters. He told me that it snowed in Chicago today, our first of the year.

We took an early bus for Knoxville, dropped our bags at the Andrew Johnson Hotel and boarded another bus for Clinton, a small town that lies within a few miles of the farmlands that will be converted into Site X. Here we got off for a visit to Norris Dam and sightseeing until another bus came along to take us back to Knoxville where we spent the night in the Andrew Johnson Hotel.

Saturday, September 26, 1942

Helen and I were up early in order to catch the 7:00 a.m. train for Cincinnati. Our sleep at the hotel was not restful because of all the raucous people who swarmed into town to celebrate today's University of Tennessee football game. Our train was crowded with servicemen and their families, and we stopped at many small towns in Kentucky. The high point was eating a box lunch en route. We arrived in Cincinnati at six in the evening and went dancing at the Netherlands Plaza Hotel. Our vacation now having come to an end, we caught a night train for Chicago and home.

Sunday, September 27, 1942

When we arrived at our apartment this morning, we found a telegram from Melvin Calvin in Berkeley. He wants me to be his best man when he gets married October 4. For some time I have wanted to return to Berkeley to get a fresh perspective of the work going on there, especially to confer with Latimer and his group, to see what progress Kirk is making with his ultramicrochemical balance, to visit the 60-inch cyclotron, and to have a talk with Lawrence about his program. I can seize this opportunity and accept Calvin's invitation also.

Monday, September 28, 1942

Upon returning to Jones Laboratory this morning, I found that my group has been extremely active all week during my absence.

Cunningham, Werner and Cefola have spent the last two weeks doing experiments and recovering the 94 from the various fractions and residues following their experiments using 94 from Perlman's, Kohman's and Jaffey's batches. Cunningham and Werner have prepared a "stock solution" of pure 94 nitrate containing about 2 γ (micrograms) of 94 per λ (cubic millimeter) of solution. This they plan to use to test the solubilities of a number of 94 compounds to give information that might be useful in developing a procedure for the separation of 94 from uranium and fission products in neutron-bombarded uranium from a pile. They have perfected methods for the determination of solubility of 94 compounds.

In their experiments a small amount of 94 nitrate (containing approximately 0.1 γ 94) is placed in 2 λ of solution, the appropriate precipitating agent added, the mixture centrifuged, the supernatant liquid removed and replaced by about 5 λ of the medium in which the solubility of the compound is to be measured. The two phases are mixed by vigorous stirring, allowed to stand overnight or longer at room temperature ($25^{\circ}\text{C} \pm 5^{\circ}\text{C}$). Then a measured volume of the supernatant is withdrawn and its alpha activity determined. Solubilities of 94 (plutonium) are calculated in terms of the concentration of the element, assuming the specific activity to be 167,000 alpha disintegrations per microgram of plutonium per minute (half-life of 20,000 years).

On Saturday, upon measuring the supernatants of the various precipitations performed the day before, Cunningham and Werner found the following solubilities:

9/28/42

<u>Precipitant</u>	<u>Compound</u>	<u>Medium</u>	<u>Solubility (mg Pu/liter)</u>
KIO ₃	plutinous iodate	sat'd KIO ₃ soln	2.1
"	" "	1/2-sat'd KIO ₃	1.8
"	" "	sat'd KIO ₃	4.8
"	" "	3 M HNO ₃	
"	" "	sat'd KIO ₃	6.2
"	" "	6 M HNO ₃	
HF	plutinous fluoride	H ₂ O	10.8
"	" "	3 M HF	12.3
"	" "	6M HF	44.8
NH ₄ OH	plutinous hydroxide	H ₂ O	1.8
"	" "	conc. NH ₄ OH	0.24

Also on Saturday Cunningham and Werner received Goldschmidt's one-fourth portion of 94²³⁹ (batch No. 4) from the large St. Louis neutron bombardment of uranium. This consists of about 8×10^6 alpha-particle disintegrations per minute, corresponding to about 70 micrograms of 94²³⁹ in a volume of 25 cc. To this they added about 3×10^6 alpha-particle disintegrations per minute that they have recovered from the residues of Kohman's and Jaffey's portions during the last couple of weeks.

Brown and Hill have been working with Donald S. Webster, one of the du Pont chemical engineers assigned to our program, to test the possible practical application of their volatility separation process. Last week, using a vertical column, they worked on the production of UF₄ through hydrogen reduction of U₃O₈ to UO₂ and subsequent hydrofluorination. They encountered considerable "caking" of the UF₄ produced in this manner. The technique they finally developed is one in which the gases are actually bubbled through the solid uranium oxide powder, and this seems to work quite well.

They also performed a series of experiments to test the volatility of element 93 in the form of the higher fluoride. A known quantity of 93²³⁹ tracer was added to some uranium nitrate, and this was then converted to hydrofluorination. Samples of this were then heated in a fluorine stream

9/28/42

for a half-hour at various temperatures between about 140°C and 300°C and higher. Their experiments showed that the volatilization of element 93 in fluorine is much like that of uranium and unlike that of element 94, whose fluoride volatilizes at higher temperatures. These experiments indicate that 93 would be readily separated from 94 in the fluoride volatility separation process.

Since the first of the month Cefola has been working on the isolation of pure 94^{239} using his portion of Perlman's batch. On September 14 he received the final concentrate of Jaffey's batch (no. 3), which had a total of nearly 7×10^6 alpha disintegrations per minute in a volume of about 12 cc. He has performed oxidation-reduction cycles similar to those that Cunningham and Werner have been using and has succeeded in isolating the 94 in a moderately pure form. I learned that last Monday he took a sample of the nitrate, put it on a platinum weighing boat, ignited it to the oxide and found a weight of 4.69 γ . The corresponding alpha activity was 194,000 alpha particle counts per minute, indicating a specific activity of 104,000 alpha disintegrations per minute per microgram of 94. This would indicate that Cefola's sample was somewhat impure when compared with the value of the specific alpha activity obtained by Cunningham and Werner on Friday, September 11 (167,000 alpha disintegrations per minute per microgram).

On Saturday Cefola used the stock 94 nitrate solution to make observations on some precipitation reactions of insoluble 94 compounds. He evaporated to dryness approximately 0.1 λ of 94 nitrate solution, added an excess of half-saturated solution of NaH_2PO_4 and observed a white gelatinous precipitate which was soluble in concentrated HCl. In another experiment, after evaporating to dryness a few tenths of a λ of the 94 nitrate solution, he added an excess of saturated K_2SO_4 and observed a white precipitate which may be due to a double salt.

Today, continuing his experiments on the precipitation of 94 compounds commenced on Saturday, Cefola evaporated a few tenths of a λ of the stock 94 nitrate solution to dryness, then added an almost saturated solution of Na_2CO_3 and observed a white gelatinous precipitate.

9/28/42

Early last week Perlman, Knox and Apple demonstrated that 94 is about 80% oxidized by 0.1 N $\text{Cr}_2\text{O}_7^{-2}$ in 0.5 N HNO_3 and 10% UNH solution in 30 minutes at 50°C and completely oxidized in 30 minutes at 65°C. On Saturday they demonstrated that 0.1 N $\text{Cr}_2\text{O}_7^{-2}$ in 0.5 N HNO_3 and 10% UNH solution oxidizes 94 in 15 minutes at 65°C. Continuing today, they find that 0.1 N $\text{Cr}_2\text{O}_7^{-2}$ in 0.5 N HNO_3 and 10% UNH solution oxidizes 94 in 15 minutes at 50°C. As they were conducting their experiments on the oxidation of 94 with 0.1 N $\text{Cr}_2\text{O}_7^{-2}$ during the last ten days, Perlman, Knox and Apple have also interspersed a number of experiments testing the reduction of oxidized 94 with H_2O_2 . They find that by using 0.3% H_2O_2 in 1.0 N HNO_3 and 10% UNH solution at 50°C, the 94 is about 50% reduced in 15 minutes and is completely reduced in 30 minutes and one hour. In similar experiments conducted at 27°C they find about 50% reduction in one hour and essentially complete reduction in two hours and 18 hours.

The experiments by Perlman, Knox and Apple during the last ten days indicate that $\text{Cr}_2\text{O}_7^{-2}$ should be a good oxidizing agent and H_2O_2 a good reducing agent for use in the oxidation-reduction cycles of the "Wet Fluoride Method" for separating 94 on a large-scale production scale. In the course of these experiments they have also shown that 94 in its lower oxidation state is precipitated by the addition of rare earth carriers to a solution already containing HF, i.e., 94 is precipitated upon a preformed rare earth fluoride precipitate. Previous experiments by Wahl at Berkeley and English here using the 50-year 94^{238} as tracer have given the same results. The present experiments, however, differ in that 94^{239} has been used; hence, the ratio of weight of lanthanum carrier to the weight of 94, which is about 10^7 , is much closer to plant operating conditions than in Wahl's and English's experiments. In the extraction of 94 produced by the chain reaction in the production pile, it is contemplated that the ratio of lanthanum to 94 will be of the order of magnitude of 100. We plan to check whether or not 94 will precipitate quantitatively under these conditions by performing experiments on the ultramicroscale with the aid of 94^{239} .

Jaffey, having completed his work on the extraction of 94^{239} from the bombardment of UNH at St. Louis, started a program last Thursday to

9/28/42

investigate whether 94 can be separated from uranium and the fission products in a separation process that utilizes the volatility and non-volatility of the chlorides. He is adding 50-year 94 tracer to UNH, converting by heating to U_3O_8 , and then treating this with chlorine to volatilize UCl_5 . For this effort he is working in the fume hood just outside Room 403.

Covey and his boys have continued their UNH recrystallization and have nearly finished an amount suitable for the next neutron bombardment at St. Louis.

Heydenburg in the Department of Terrestrial Magnetism, Washington, D.C., answered my letter of September 18 and explained that he plans to compare the fission yield of our 94 sample with an ordinary uranium sample that has been uniformly deposited. Because his ionization chamber might have a different counting efficiency for a nonuniform sample, he states that he prefers to receive the 94 sample as uniform as possible.

One of the first steps that Compton is taking to expand the Met Lab's program to Site X is to compile short descriptions of all the facilities that will be needed there. My contribution, which concerns the chemical extraction plant, went to Stearns in the form of a memorandum:

"One of the buildings at the plant site will be devoted to the chemical extraction of the 94^{239} from the mixture of uranium and fission products. This building or group of buildings will be designated as the chemical extraction plant. The 94^{239} is uniformly distributed, in small concentration, throughout the entire mass of the uranium, and can only be extracted by subjecting the uranium mixture to chemical operations on a rather large scale. This building will contain the industrial-sized chemical equipment to be used in the chemical extraction operations, which have been developed in the Metallurgical Laboratory here. These chemical processes will be complicated over ordinary industrial chemical processes in that the strong radiation from the fission products will be present and therefore there will be included within the chemical extraction plant radiation shields made out of concrete and heavier materials such as steel or lead. Also, the plant will contain special equipment to make possible remote control operations in carrying out the chemical separations."

9/28/42

A letter from Kennedy was waiting on my desk. One matter concerned a message that Lawrence has received from Wensel, the technical aide to the S-1 Section, requesting a final report on contract OEM-206, which closed last July 31 and covered some of the work in Gilman Hall and the cost of the large neutron irradiations of UNH, including the one from which Wahl is isolating his large sample of 94^{239} , and the thorium irradiations of Gofman and Stoughton. I immediately responded with a telegram saying I shall take care of it.

The second paragraph of his letter reads as follows: "A somewhat more complicated matter is this business of Kirk and the ultramicro-balance. Kirk and company are working like demons down in Life Sciences Building, and I have been asked to supply them with what information and advice I could. So far as I know, they have not been told just what the balance is for or even what element is involved. Obviously, such a balance is so complicated that some knowledge of the required manipulation technique is necessary for its proper construction, or at least for the proper design of its case. This will all have to be looked into later; in the meantime I would like to know just what you expect of Kirk and his group. Are they to finish the balance and then begin a study of the chemistry with it? At present, the idea at this end seems to be that they are, if possible, to ship a finished balance to Chicago and call that the end of their project, or perhaps only of one phase of it. And one other thing. The secrecy angle has been emphasized quite a bit here recently. Kirk feels that his program is entirely secret and has been considerably alarmed to find that several people, both on campus and off, know what he is building."

He added a postscript that S. H. Babcock, an assistant professor of organic chemistry at Davis, wants to get into defense work, and that my old friend, Don Hull, who is in Berkeley for a visit, "will look for you in Chicago on his way back to New York."

Indeed, there is a letter from Hull announcing his arrival on the Union Pacific's "City of San Francisco" today. The reason for his stop-over, he says, is that Dunning (with whom he works at Columbia University) thinks I might be able to impart some ideas on the chemical and

9/28/42

radioactive purification of uranium. After phoning from the station, he came out to see me and we spent a pleasant hour together.

Fighting continues in Guinea, and the Allies have swept the Japanese back for two days in a row. The seesaw fighting in Stalingrad favors the Soviets today; they are beating off the Nazis.

Tuesday, September 29, 1942

Jaffey finds in his chloride volatilization experiments commenced last Thursday that an appreciable fraction of the tracer 94 is carried over with the volatile UCl_5 .

I replied to Kennedy's letter and explained how I could provide Wensel with the information needed to close out contract OEM-206. With regard to Kirk, I said: "In the matter of Kirk and co-workers, I might say that since I plan to visit Berkeley, arriving about this weekend, I shall take this occasion to talk to Kirk at that time. However, I hope to be able to talk to you and Latimer about it before I see Kirk. The combination of Kirk, Craig and Gullberg is rather larger and more high-powered than I had anticipated; however, I suppose this is to our advantage. They have not been told just what the balance is for or what element is involved. I am sure that Compton would not authorize their undertaking a study of the chemistry, and I believe that Latimer does not favor it. However, there are a number of problems of complicated ultra-microchemical technique in which they can contribute heavily to the general program, and I should like to discuss this with you when we have our talk.

"The question of secrecy is a very serious one, and I am trying to look into the problem which you raised in your letter. It may involve Latimer and the Gilman Hall crew, most of whom know about Kirk's program. I don't remember that I have ever mentioned much to Kirk about the existence of Latimer's program and his relation to this program, which of course I should have done." Also, I remarked that I know Babcock and agree

9/29/42

that he must be a good man that possibly there might be a place for him here later.

Others to whom I dictated letters were Kirk, Baumbach and Winstein. I told Kirk of my visit to Berkeley next week and that I planned to confer with him on his future program. Kennedy, I said, had told me about his (Kirk's) concern over the secrecy of his project and that I would be looking into the matter. My letter to Baumbach was short: "I am going to Berkeley via Los Angeles this weekend and will be home in South Gate during Saturday afternoon. If you will phone me early Saturday afternoon, perhaps we can arrange a meeting out in South Gate since I certainly would like to see you and talk to you about the matter which is of so much interest to both of us." I wrote to Winstein in the same vein. I still would like to add both of these men to my staff.

Thompson wired that he will be arriving on the Santa Fe, El Capitan, this Thursday at 7:15 a.m., and I responded with another telegram telling him to take a taxi to my home at 6128 South Woodlawn, or, if an hour late, to come to my office, Room 403 in Jones Laboratory. A second telegram went to Latimer, now back in Berkeley, informing him of my impending visit, and a third telegram went to Wahl, asking if he can get his input to our joint bi-weekly report here by Thursday.

I received a copy of a memo from Allison pointing out that the Technical Council, consisting of Compton, Fermi, Wigner, Szilard, Allison, Wheeler and Moore (a smaller group than the previous Technical Council), with Oppenheimer as a visiting member, will take a more active part in reviewing the problems of the Project. Allison says in this memo that a group of Research Associates will be informed, before the meetings, of the problems confronting the Council and, after the meetings, of the decisions reached so we can express our ideas to the members of the Council. A meeting of the Council will be held today.

At the meeting of my group's Research Associates in my office this evening I was brought further up to date on the many exciting experimental results obtained during my absence last week.

The Technical Council, with Compton, Fermi, Wigner, Allison, Wheeler, Moore and Oppenheimer present, met to review some of the major problems of the Project. Compton brought the Council up to date on the matter of Site X and the new organization of the nation-wide S-1 project. On Wednesday of last week, in Secretary Stimson's office, there came into existence a policy committee which will represent the S-1 (OSRD Section on Uranium) scientists and the military. Bush, with Conant acting as his alternate, was appointed Chairman; General Styer will represent the Army and Admiral William R. Purnell will represent the Navy. The commanding officer is Brigadier General Leslie R. Groves of the Quartermaster Corps. The committee has been likened to a corporation, with Groves as president and Bush, Styer and Purnell as directors. The committee will determine all policy matters but will lean heavily on the S-1 Executive Committee for advice. Research and development will still be a function of the S-1 Section, both for our work here at Chicago and for the isotope-separation projects. The pilot plant for the Metallurgical Laboratory will be the responsibility of the OSRD while under development and of the Army when used for production. Du Pont Company is now being considered as the operating company. Two weeks ago the S-1 Executive Committee recommended the selection of Site X, and on September 19, two days after getting his appointment, Groves issued a directive taking over the site, which has an area of roughly 100 square miles.

Because the discussion at the meeting was so long and rambling, I will paraphrase and condense the remainder of the minutes that were written up.

Oppenheimer: Of Lawrence's laboratory staff, probably about half will go to Site X. Fast neutron work has no home, may need one.

Compton: General Groves requests that two weeks from last Saturday we have sketch drawings of our installation in hands of Stone and Webster. What should be location of buildings at Site X that were originally planned for Argonne Forest? Fast neutron work should trend to Site X. Cooper's work should be there in perhaps six months. Question about Seaborg's work. Get some laboratory

9/29/42

space prepared in three or four months. Army would like to have all work in one enclosure.

Oppenheimer: Transition from research to development easier if not separated by 500 miles.

Compton: Stone and Webster have contract for construction. If du Pont accepts operation, some of their engineers will probably take a part in the construction.

Wigner: Hand over in this way an immensely valuable store of knowledge to a private concern.

Compton: Problem considered by Army and Executive Committee, the responsible groups. All patent rights will belong to the Government; how engineering and technical knowledge are to be shared with the British is a problem not yet solved. Du Pont will probably be a subcontractor under Stone and Webster, responsible for chemical separation process. Possibly General Electric or Westinghouse may have similar subcontracts for work of isotope separation.

Allison: If cyclotron is to be set up at Site X, move Fermi there.

Wheeler: Factors in location of research work--library, purchase of scientific equipment, secrecy. Chemical engineering work of Cooper will evidently go to Site X. No sharp boundary between test tube, dishpan and full-scale separation work. Seaborg feels his work should go where Cooper goes.

Compton: Stone and Webster need indication of what we need. Use Whitaker's drawings of Argonne Forest. Oppenheimer has plans in mind for fast neutron work. Cooper needs accommodation. Seaborg's move at same time is questionable. We will be going strong on research here six months from now.

Oppenheimer: Plans for fast neutron laboratory include 40 laboratories and offices, but not all this space needed for the time being.

Compton: Some individual needed to collect ideas as to what is needed in the immediate future at Site X. Whitaker? Mitchell? Dempster?

Allison: It would simplify problem to eliminate long-range questions and say what we want at Site X in the next six months.

Moore: Put in during next two weeks request for constructing at Site X what we need on an absolute minimum basis for a pilot plant.

9/29/42

Oppenheimer: If main physics work is not to be at Site X, question of placing fast neutron work at that site should be reconsidered.

Compton: Laboratory plans under discussion now are not for construction at same date as pilot plant buildings.

Fermi: Laboratory in small town?

Wigner: Knoxville is to Site X as Trenton is to Princeton.

Compton: Cooper and Seaborg will eventually go to new site.

Coalesce Fermi's work with fast neutron work.

Fermi: Exponential pile work should go with planning, as source of engineering data. Personal feeling against moving. Feel it a mistake to shift fast neutron work to Site X. Of a more unexpected character than work so far; should be nearer sources of supply than Site X; difficulty to set up cyclotron.

Compton: Cooper has to be at pilot plant. Gas and all such facilities should be ready in six months.

Moore: Move chairman appoint subcommittee to make preliminary estimate of space required to house chemical engineering and Seaborg's work.

Compton: After six to twelve months slow neutron workers might be shifted to fast neutron work. Reason for moving fast neutron work to Site X: concentration of that work desirable. Memo by fast neutron workers on requisites of site: No Army control, freedom from radioactive contamination. Possibly Cincinnati. Estimate at least 12 months, probably 18 months, to have cyclotron and high voltage machine in operation. Use facilities elsewhere until that time. Certainly 1944 before significant tests on ultimate product.

Moore: Engineering development work more immediate than fast neutron work. Feel this should be close to physics work--either to cyclotron or pilot plant. General facilities at Site X more important than laboratories for Cooper's and Seaborg's groups.

Wigner: Rewording of Moore's motion. Move chairman appoint subcommittee to draw up tentative plans for construction of absolute minimum of buildings at Site X necessary for operation.

Allison: Appoint Whitaker as Chairman, Steinbach, Cooper, Moore.

Wednesday, September 30, 1942

Stoughton wrote a four-page letter. He is sending me 250 microcuries of Pa²³³, and later some U²³², that Gofman said I requested. He reports on his difficulty in working up the target from a 500 microampere-hour run of deuterons on thorium (to produce Pa²³² and daughter U²³²). The big run on thorium plus neutrons (to produce Pa²³³ and daughter U²³³) apparently has a lower yield than expected; but the chemistry, which he describes in detail, went satisfactorily; he expects to find about 8 to 10 micrograms of U²³³.

"As I told you," he wrote, "Fontana is now working on the uranium-thorium separation with me. Since he wants to get as close to organic chemistry as possible, he is now working on the ether extraction and will later work on organic compounds of uranium and thorium as a means of separation. I am putting all available time on inorganic methods and any other methods which can be found. I believe several methods will work all right, but they all so far involve removing the thorium from the uranium, except for the ether extraction which does look somewhat promising. If any work has been done that you know of on the effect of radiation on organic material (especially ether), I would like to know about it, since the Pa²³³ will make the thorium very active."

Helen and I moved from our small first floor apartment to a larger, front apartment on the fourth floor of our building (6128 Woodlawn Avenue). The Ghiorso's have moved from their temporary hotel quarters to a second story, front apartment in the same building.

OCTOBER 1942

Thursday, October 1, 1942

Stanley Thompson showed up at the apartment at about eight o'clock this morning--he came from the railway station by taxi as I suggested. After eating breakfast with us while Helen and I reminisced about our vacation in the Great Smoky Mountains, Stan and I walked to the campus, where I got him started on his "processing" through employment as a Research Associate and through the security procedure. Later he came to Jones Laboratory. I introduced him around to the group and showed him his laboratory bench (no. 5) in Room 404 that Covey will clear for him before he starts work. He will have his desk in the space between his laboratory bench and the west wall of the room.

I sent a letter to Hamilton in Berkeley, telling him I expect to be there next week and hope to see him.

One of the surprises today was to see my old friend Ed McMillan, who is here to visit Manley. He has finished his work with the U.S. Navy San Diego and will now join Oppenheimer to conduct fast neutron studies, which has for its ultimate goal, of course, the design of nuclear bombs.

My trip to Urbana, Illinois, went smoothly. I was met at the station at 5:20, had dinner with some of the officials of the University of Illinois Section of the American Chemical Society and later presented my talk, "Applications of Artificial Radioactivity to Chemistry, Biology and Medicine." I plan to return home tomorrow morning.

The Technical Council met at 1:30 this afternoon, with Allison, Compton, Cooper, Doan, Fermi, Manley, Moore, Szilard, Wheeler, Whitaker and Wigner in attendance. McMillan was a guest. Allison brought up the subject of a bismuth-cooled plant and a subcommittee

10/1/42

of Cooper and Young was formed to report back in two weeks on the practicability and possible time-schedule for the construction of such a pile. Compton showed a memo from Groves concerning the building plans at Site X. Groves wants to have sketch layouts for those buildings immediately needed in Steinbach's hands by Saturday, October 10, and more detailed plans by October 24. These buildings are to include general and specialized shops and a laboratory for 200 persons. When McMillan presented the requirements for a fast neutron laboratory to the Council, a general discussion was precipitated as to where it should be located. His plans include 21 offices and four computation rooms, 18 laboratory rooms, a library and conference room, special facilities such as a cyclotron, Van der Graaff and D-D source, a glass shop and a metal shop. Allison quoted Oppenheimer as saying that fast neutron work should not be isolated from other physics, and to be under the Army or a contractor would only hamper it. Compton replied that all research at Site X will be under an independent institution and not under Army or an industrial organization. The question was raised as to what alternatives there are to placing a fast neutron laboratory at Site X. McMillan said that an existing laboratory could be used; Wheeler thought that wooden buildings on the midway might be constructed; and Szilard wondered about using the Museum of Science and Industry. Nothing was settled.

Compton told the group that Groves notified him this morning that du Pont will take over the development and initial operation of the pilot plant for 94 chemical separation. Another long discussion ensued as to the advisability of having a united laboratory at Site X. Whitaker said minimum facilities required at Site X are: administration building, developmental laboratory, health building, analytical chemistry service and physics buildings, shops and warehouses, No. 2 and No. 3 piles, and a 94 chemical separation plant. Wheeler quoted me as saying that a 94 chemistry laboratory would be required, with space like that of the new chemistry building being erected at Ingleside Avenue. Cooper pointed to everyone at the table and said they all will be going to Site X, that it will be necessary for me and my group to be there in case of trouble. A poll was then taken in response to Szilard's question: Should a research

10/1/42

laboratory, as distinct from a plant laboratory, be at Site X? Allison summed up the answers by saying, it is the opinion of the Council that research should be not concentrated at Site X if it can be concentrated at Chicago with a saving in time. Thus it can be said that the Council did come to one decision today. Also, the need for a very early decision on the type of cooling for pile No. 2 was stressed.

Friday, October 2, 1942

I spent a comfortable night in my hotel room and early this morning departed by train for Chicago. My talk last night cost the Society one dinner, \$9.31 for round-trip train fare and \$2.75 for the hotel bill—I bought my own breakfast!

English, during the last couple of weeks, has been setting up, with the help of Ghiorso, an ionization chamber connected to a linear amplifier, similar to those that we used in Berkeley, in order to make another determination of the cross section of 94^{239} relative to that of U^{235} for fission with slow neutrons. We have a one-gram Ra-Be neutron source for this purpose. The 94^{239} sample, mounted on a copper disc, is placed on one electrode of the ionization chamber and measurement will be made in the presence of paraffin to produce the slow neutrons, with and without a cadmium shield, in order to correct for the effect of fast neutrons. The 94^{239} samples will be furnished by Cunningham from the material he has isolated, and comparisons will be made with 200-microgram samples of natural uranium, prepared by electroplating onto copper from alcoholic solutions of uranyl nitrate.

I wired Baumbach and Winstein that I have changed my plans and am going directly from Chicago to Berkeley and will notify them before I go to Los Angeles.

It was with some confidence that I was able to write to Heydenburg at the Department of Terrestrial Magnetism in Washington and say that we will

10/2/42

be shipping him a ten-microgram sample of 94 within a week. Such a statement just a month ago would have been unthinkable.

I sent a letter to I. Lyon Chaikoff in the Department of Physiology at Berkeley saying that I hoped to clear up a misunderstanding regarding our contacting his students about possible employment at the Met Lab. I said that Isadore Perlman was the only one I have taken the initiative to contact; the others approached us on their own, e.g., Glenn Sheline, who came to work with me at Berkeley, and Bernard Fries who is currently under consideration. I expressed my belief that the opportunity to work on our project could not be exceeded by any other position that might be offered, that the project undoubtedly will have post-war significance, and that the importance the project is apparently attaining is such that it should be a source of pride to him that his men may fill important positions as radiochemists and radiobiologists. I mentioned that I would be in Berkeley the week of October 5 and perhaps we could discuss these matters.

Before leaving for California this evening I managed to put together our joint Chicago-Berkeley "Report for September 16-30, 1942. Chemistry of 94. University of California and University of Chicago Groups" (No. CN-282). In our part of the report Cefola, Cunningham and Werner describe their work, using ultramicrochemical techniques, on the preparation and measurement of the solubility of pure element 94 iodate, fluoride and hydroxide, and other compounds. On the fluorine method for separating element 94, Brown, Hill and Webster report on their measurement of the volatility of element 93 fluoride as a function of temperature and its behavior, which is much like uranium; this indicates that any element 93 present in the pile material will go wherever the uranium goes in the fluorine method of separating element 94. Their work on the use of bubble agitation techniques for the conversion of oxide powder to the tetrafluoride is also discussed. Willard and Turk describe their experiments indicating that precipitation with 8-hydroxyquinoline (oxine) may be a useful method for separating 94 and 93. Apple, Knox and Perlman cover their program to study the problems of transferring the Wet Fluoride Method for separating 94 to commercial-size scale. They have carried out

10/2/42

preliminary experiments on the choice of an oxidizing agent (dichromate studied), the choice of a reducing agent (peroxide studied), effect of air agitation on reduction, and the precipitation of 94 on a preformed precipitate of lanthanum fluoride. In the Berkeley part Garner reports on "Volatility of 94 and 93 Compounds" (the separation of volatile 93 and 94 chlorides is described), Garner on "Oxidation Reactions of 94 and 93," and Duffield on "Precipitation Reactions of 94 and 93."

Cunningham prepared on a platinum plate, using some of his pure 94^{239} , a sample containing about 10 micrograms of 94^{239} (by rough estimate) for me to take to Berkeley when I leave this afternoon for use in their experiments to measure the neutron fission properties of 94^{239} .

I am also taking with me a sample of natural uranium mounted on copper, weighing about 200 micrograms, in order to have its actual weight determined by measurements of slow neutron-induced fissions by Gofman and others at Berkeley using their setup. This is one of the samples being used by English in his measurements of the slow neutron fission cross section of 94^{239} relative to that of U^{235} .

At a little before 8:00 p.m. I boarded the streamliner "City of San Francisco" for Berkeley. One of the drawbacks in visiting my colleagues in Berkeley is the time lost in travelling by train--nearly two days each way. This time, however, I have the companionship of E. O. Lawrence's brother, John, who is associated with the University of California School of Medicine, and Bob Stone, our new head of radiological safety on the Metallurgical Project.

Saturday, October 3, 1942

Most of my day was spent talking. Lawrence, Stone and I finished breakfast on the way into Cheyenne, ate lunch near Rawlins, Wyoming, and dined in Ogden, Utah. Many hours were spent with Stone in his roomette discussing present and future programs concerning the safe handling of 94 and fission products. I am happy that Stone is now in charge of

10/3/42

radiological safety for the Metallurgical Project and that the importance of this has finally been recognized.

Sunday, October 4, 1942

Our train arrived in Berkeley shortly before nine in the morning. It was not yet noon when I served as best man at Melvin Calvin's wedding to Genevieve Jemtegaard. The ceremony was followed by a lunch for all the guests at the Claremont Hotel in Berkeley. Many of us then went with the Calvins to their apartment for a few hours until they left on their honeymoon. I am sleeping at the Faculty Club tonight and plan to make it my quarters while in Berkeley.

Monday, October 5, 1942

After a long talk with Latimer and reviewing his Berkeley program, I visited Wahl in his laboratory. He very proudly showed me a visible sample of plutonium (IV) hydroxide, the end product of his extraction of the uranyl nitrate hexahydrate that was bombarded for two months in the 60-inch cyclotron. It weighs 200 micrograms and was finally isolated last Tuesday. On that momentous day, Wahl showed the 94^{239} sample to E. O. Lawrence. I am sorry that I wasn't there to hear his remarks and to see the expression on his face.

Tuesday, October 6, 1942

I paid a visit to Kennedy and Gofman in their work areas and they both invited me to dinner later this week. Gofman was particularly pleased to get the sample of 94^{239} that I brought with me from Chicago. Later I flew to Los Angeles to spend the night with my parents at 9237 San Antonio Avenue, South Gate. I was also able to see Harlan and Nathalie Baumbach and Saul Winstein. Baumbach told me he is interested in joining me at the Met Lab but to obtain a release from his employer at Paramount

10/6/42

Pictures will probably require a letter from some high official in Washington; I promised him to look into this. Winstein told me the chances of his joining me are very slim.

Wednesday, October 7, 1942

This morning I flew back here to Berkeley and then went to see Hamilton, Lawrence and Cooksey in turn; each seemed pleased with my visit. I was given a tour of the ever-expanding Radiation Laboratory on the hill above the Berkeley campus. Here I saw the 184-inch cyclotron magnet with its two giant calutron tanks. One of the calutrons was in operation; peering through a large porthole, I saw the spectacular blue glow of a beam that carried U^{238} into one receiver and the rare U^{235} into another. Lawrence, as ever, is optimistic about the electromagnetic separation process and spoke with enthusiasm about his plans to install thousands of calutron units at Site X.

I received a letter from Perlman about our move to Site X. He wrote, "As usually happens when you leave, something comes up that could better be handled by you. Whitaker called me Saturday, and we had quite a discussion regarding the pros and cons of moving this group to the plant site. This matter is to be settled probably before you return, and the recommendation is to be made by the Project Technical Council. Apparently the tentative plan had been reached that a control lab (quite small) would be set up there, but no research facilities. I gave him all the arguments I could think of as to why this group should be moved, and although he seemed to agree with them, I don't think this will bear much weight with the Technical Council. He told me that should any decision be made, he would let me know and perhaps reach you by phone.

"It seems pretty well settled that after the material received its first concentration, our group will carry out final purification. They probably reason that this is a one- or two-man job at the plant site, or that the material could be shipped to our present place. I pointed out that it would be a mistake to turn the entire extraction process over to inexperienced people, that is inexperienced in radio-chemistry. I will

10/7/42

probably hear from you soon after you receive this letter, and would appreciate your giving some thought to this matter with respect to how I might forestall an adverse decision in this matter. I will also try to see Whitaker again before you call."

Perlman also wrote on another matter. Chaikoff of Berkeley has written to him, asking for some advice in getting a war project going in his laboratory. Apparently, according to Iz, there is a terrific amount of red tape that the medical people have to go through in order to get a contract. Perlman's view is that Chaikoff has much better facilities for doing project-related medical work than most places and he has several experienced men on his staff; so Hamilton should farm out some of his work to him.

In order to allay any further worry on Perlman's part about our move to Site X, I put through a telephone call to him, and we discussed the best course of action and the strategy we would employ with Whitaker.

Oppenheimer and I had a talk about 94 production and its availability to the fast neutron workers. In discussing the spontaneous fission of $^{94}_{239}$, he was of the opinion that if the half-life is of the order of 10^{19} years there is no cause for alarm. In such case, neutrons would be emitted so infrequently that none would be emitted to prematurely trigger a chain reaction in the bomb.

I had dinner at the Gofman's and then returned to the Faculty Club.

Thursday, October 8, 1942

Besides visiting some of the other chemistry groups today, I visited the Life Sciences Building and inspected the superb work Kirk and his colleagues are doing on their new microbalance, briefed them on the role of their work in the overall Metallurgical Project, and invited Kirk to join our group in Chicago when he is finished. I also saw Chaikoff and settled amicably the matter about what appeared to be our pirating of his

10/8/42

workers. I followed up on Perlman's idea and suggested to Chaikoff that he get in touch with Hamilton about taking over one or more of his investigations.

I had an enjoyable dinner at the Kennedy's and again spent the night at the Faculty Club.

Friday, October 9, 1942

After having breakfast at the Faculty Club, I went to the Chemistry Department and talked to Mrs. Lois Moquin about some contractual and administrative matters. The rest of the day was spent in revisiting some of the 94 chemistry projects. I had an early dinner in Berkeley and took a taxi down University Avenue to the Berkeley railroad station, where I met the "Overland" which departed San Francisco an hour earlier. I will not arrive in Chicago until Monday morning.

Monday, October 12, 1942

We rolled into the Chicago and Northwest Railway Station at 8:30 this morning and Helen and Iz were there to greet me. The weather was warm and clear, already in the 70's. When I asked Iz what action Whitaker has taken with the Technical Council about our move to Site X, he told me to relax. As far as he can tell, Whitaker was swayed by his arguments and has dropped the matter of setting up only a small chemistry control unit at Site X and thus keeping our research group in Chicago so far from the chemical separation plant. My first task of the day was to review the work going on in my group and to read some reports on Met Lab activities.

During the last couple of weeks, since Saturday, September 26, Cunningham and Werner have been involved in the isolation of a large sample of 94^{239} using as their source Goldschmidt's one-fourth portion, augmented by additional residues from Kohman's and Jaffey's batches, from the large St. Louis neutron bombardment. They have carried out a very

10/12/42

exhaustive procedure of purification and have come up with a partial recovery of about 80 micrograms of relatively pure material as the nitrate in HNO_3 solution.

Last Thursday, they took a small sample of this stock of plutonium nitrate and transferred it to a platinum weighing boat, ignited it at 700°C for 20 minutes and weighed it with the Salvioni balance. The ensuing plutonium oxide was found to weigh 2.20 micrograms, corresponding to 1.94 micrograms of plutonium on the assumption that the formula of the oxide is PuO_2 . The oxide was dissolved in concentrated H_2SO_4 and an aliquot taken for alpha counting leading to the determination that the total alpha-particle disintegration rate is 320,500 per minute corresponding to a specific activity of 163,000 alpha-particle disintegrations per minute per microgram of plutonium. Again an alpha-particle counting efficiency of 45% is assumed.

On Saturday they took some of their stock solution of plutonium nitrate to prepare a sample for Heydenburg to use in his measurements of the fast neutron fission cross section of 94^{239} ; they transferred the solution to a platinum disc and transformed it to iodate by adding a solution 0.4 M in iodic acid and 4 M in HNO_3 . The iodate was dried and ignited. From the volume and specific activity of the stock plutonium nitrate solution, as determined by measuring the alpha emission rate of an aliquot fraction, it was calculated that there should be a 1.19×10^6 alpha disintegrations per minute present on the disc. When English counted this directly on our low geometry alpha counter, however, he found a value of 7.69×10^5 alpha disintegrations per minute. This discrepancy indicates that there may be something wrong with our calibration of the efficiency for counting alpha particles on our low geometry ionization chamber, and perhaps something wrong with the assumed geometrical efficiency (45%) of the "inside" ionization chamber used by Cunningham and Werner to determine the total alpha-particle intensity of the sample by the counting of the aliquot fraction.

Using the sample of 94^{239} prepared for Heydenburg, English and James made adsorption measurements in a search for gamma rays using a Geiger-Müller counter. The plutonium sample mounted on a platinum sheet, has an alpha disintegration rate of about 10^6 per minute and gives a counting rate of 5 per minute or less through 3 gm/cm^2 of lead. Taking into

10/12/42

account the geometrical arrangement and the efficiency of the counter for gamma rays, we estimate that the 94^{239} sample emits about 10^3 gamma rays or less per minute; that is, roughly 0.1% as many gamma rays as alpha particles. There is also an electron counting rate corresponding to about 10^3 particles per minute through a thickness of 10 mg/cm^2 (cellophane and mica counter window). There may be some contribution due to fission product impurity.

Last week Willard and Turk measured the effect of concentration of 94^{239} on its adsorption by Hyflo Super Cel. Using some 94^{239} furnished by Cunningham and working on the semi-microscale in order to effect high ratios of 94^{239} to uranium in 10% UNH solution, they found that up to 40% of 94 is still adsorbed on Hyflo Super Cel at concentrations as high as one part of 94 in 7,800 parts of uranium. Since the 94 present in the uranium after the operation of a pile may have as high a concentration as one part in 10^3 - 10^4 of uranium, these experiments indicate that Hyflo Super Cel may have sufficient capacity at actual extraction plant operating conditions.

I had a talk with Stan Thompson about his research plans and he told me he has a number of ideas for the use of precipitants to carry 94 and organic complexing agents to purify it after it has been removed from the bulk of uranium and fission products. He has already started experiments with diphenylthiocarbazon (dithizone) in chloroform.

Jaffey told me he is modifying his method of chloride volatilization through the use of CCl_4 as the chlorinating agent to see whether he can prevent the carry-over of tracer 94.

During the last few days Cefola has been testing the carrying of 94^{239} , working on the ultramicroscale, on preformed precipitants of lanthanum fluoride when the ratio of lanthanum to 94 is about 100 as it will be in the application of the "Wet Fluoride Process" to the extraction and separation of 94^{239} from uranium and fission products. Working in a solution of volume 12-14 λ containing approximately 0.01 γ (microgram), he added sufficient HF to make the solution 6 N in HF concentration, then

10/12/42

added 1 λ of La^{+3} solution and found after separating the lanthanum fluoride precipitate that it carries 80-95% of the 94. He finds that the addition of a second 1 λ portion of La^{+3} leads to a combined removal of 97-99% of the 94. These and other similar experiments that he has performed indicate that removal of 94^{239} with lanthanum fluoride precipitates at the concentrations of 94^{239} that will exist in chemical extraction plant operation will be feasible.

I learned that the Technical Council held two meetings while I was in Berkeley. The plan is to meet every Monday at 1:30 p.m. with extra meetings in between if needed. At the first meeting last Monday, Groves made his initial appearance. This was Groves' first visit to the Met Lab, the purpose of inspecting the facilities and meeting the personnel. The Council meeting started out with Allison, Fermi, Szilard, Moore, Wigner, Whitaker, Wheeler and Steinbach present. Allison asked that a decision be made about pile No. 2 as soon as possible in order to design a proper building. Steinbach said that he assumed the building would be a 20' x 20' x 20' structure. The conveyors and unloading equipment have already been designed but the cooling systems are incomplete. Fermi urged that details of the pile be decided on as soon as possible, which was followed by Moore's subcommittee report on the design of a 10,000 kw reactor. The three schemes investigated were: by Wigner (1) uranium rods, water pipes and graphite; by Fermi (2) uranium lumps imbedded in graphite and cooled by water pipes; and by Cooper (3) metal pipe with graphite and uranium shot as coolant. Another scheme, (4) only 300 kw, employing external cooling, is the one being designed by Stone and Webster.

After considerable debate over the merits of the four schemes, Compton and Groves walked in and took seats at the table. Allison continued the meeting by saying that in order to have an operating pile at Site X by March 15, 1943, plans for the pile must be ready by Saturday, October 10. Groves spoke up and said now is the time to put the plans into the hands of Stone and Webster, to which Steinbach replied that some pile plans that now exist are based on scheme #2 and there is some difficulty of how to arrange 850 pipes inside the pile. After much discussion over the subject of cooling by recirculating distilled water, Groves made a pronouncement: The War Department considers the project

10/12/42

important. There is no objection to a wrong decision with quick results. If there is a choice between two methods, one of which is good and the other looks promising, then build both. Get the decision into Compton's hands by Saturday night. Moore recommended construction of scheme #4 as planned at present by Stone and Webster. Steinbach said that although General Groves has emphasized a building, the real problem is what goes inside it.

This set off another round of discussions about the relative merits of the four plans. Wigner championed his scheme #1, saying that such a pile could later be converted to a helium-cooled, high-power plant. Indeed, air or CO₂ could be used instead of helium for cooling. Fermi was not impressed, saying Wigner's pile could not be safely enclosed in balloon cloth and that fittings for a steel shell would be difficult. Allison agreed and said that such a pile might give a big output, but it needs to be engineered. Fermi then spoke for the simple 300 kw, externally cooled, pile indicating he thinks this could be built at the Argonne Forest site. After further controversy, Allison summarized the talk by saying, the question has sharpened down to: do we accept the 300 kw scheme or do we redesign? The meeting adjourned without a decision being made.

Two days later, on Wednesday at 1:30 p.m., the Council met again. Kirkpatrick of Stone and Webster was a guest, and this time Groves was absent. Allison opened the meeting by saying that on Monday someone suggested that the materials scheduled for use in the Argonne Forest pile (No. 1) be employed in the construction of pile No. 2 at Site X, which has a deadline of March 15 next year. Simultaneously, another pile of higher output could be built. Compton then gave several cogent arguments why pile No. 2 should be the exterior-cooled, 300 kw variety. He said that for military reasons Groves believes that a plant operating by June 15 would meet the deadline for a few grams of the explosive product, and probably after June 15 several more piles would be required. The pile building at the new site will be completed by February 1, and it would be possible to have a 300 kw pile operating six weeks later. Such a pile would provide engineering experience and be useful for studies related to chemical processing of 94, radioactive gases and protection against radiation. Also, there would be a few grams of 94 for physical tests.

10/12/42

Moreover, an operating pile would give a great boost to morale, because right now the Army is discouraged that the project hasn't achieved more than it has so far. A motion was made and passed without dissent that the Technical Council recommends the construction of a 300 kw pile at Site X by March 15, 1943. Another motion was carried that the council approves the expansion of the engineering staff at the Met Lab so that designs for water- and bismuth-cooled systems can be studied.

Cooper, a member of the subcommittee on space allocation at Site X, reported that plans call for a chemical separation plant there to handle the output of any pile up to 100,000 kw. The plans include facilities for three separate processes in one building, any one of which should handle one ton per day. When Fermi objected that a leak in one process might make the building uninhabitable, Cooper replied that there will be a receiving building to dispose of radioactive gases before the material goes to a second building. Here every tank will be in a separate room with its own ventilation.

With regard to laboratory buildings at Site X, Compton told the Council that Groves wants production, chemical extraction and fast neutron work at Site X. Research that is less immediate and the study of utilization of a chain reaction for power should not go to Site X. Fermi brought up the question, what should the program be at the Argonne Forest laboratory? Originally, his group was to prove that a chain reaction can take place, and then the pile would be flashed for a brief time. A dugout would be required in the latter case. He was of the opinion that the pile could be heated by one degree C, but the materials could not be disassembled and moved to Site X for several weeks thereafter. Compton said that Oppenheimer had telegraphed him Monday and urged the concentration of fast neutron work at Site X in order to speed action. It is also Groves's decision. Allison and Wheeler agreed that slow neutron work should eventually move there also, but Fermi said "no comment" when asked. Compton quoted Groves as saying to Hutchins, President of the University of Chicago, that part of the Met Lab work will be transferred elsewhere, but it is impossible to predict whether the extent of the project will increase or decrease at the University in a year's time.

I wrote Baumbach, as a follow-up to my meeting with him in South Gate

10/12/42

last Tuesday, to tell him that I have found the mechanism for getting a letter from Washington sent to his employer; I asked him to let me know if and when he wants such a letter sent to arrange for his release to join me at the Met Lab.

A third meeting of the Technical Council took place today. It was attended by Allison, Fermi, Moore, Szilard, Wheeler and Wigner. At first the meeting was devoted to a discussion of machines and materials. Fermi stated that the Council could not estimate dates for fulfillment of the stages in the pile program. There followed this exchange of words:

Szilard: Let's adopt a policy of utter frankness toward the Army.

Moore: I don't think we should say anything in case of doubt.

Allison: You know Conant; he will press for time estimates.

Fermi: In light of our past experiences, we may underestimate the amount of uranium required because of the impurities that will be found in it. Surely it is not unfair to expect a loss of one percent in k due to these impurities. I think it is a grave mistake to wait any time at all to produce a chain reaction. Now, it is possible that we can put the material into the form of a sphere at Argonne Forest. Let us use some AGR (an inferior form of graphite, single fired and of low density) to support the sphere. In fact, it may be possible to use ordinary brick or wood for the same purpose. It would be possible to build up a structure to which we can add and yet maintain a roughly spherical shape at the bottom. For speed, we can use uranium metal as it is produced.

Wigner: It seems to me that working up a time schedule while we are so uncertain about the value of k is a waste of time.

Szilard, Allison and Fermi agreed to Wigner's comment. Fermi then estimated the value of multiplication constant k as presently attainable. By adding 1.026 already measured for Westinghouse metal, 0.021 by going to pure graphite and 0.007 by exhausting nitrogen from the structure, he obtained a total for k of 1.054.

Before adjournment the question came up again about moving to Site X. Allison said another telegram came today from Oppenheimer

10/12/42

asking that there be no delay in the construction of a fast neutron laboratory at Site X but that he, Allison, is even opposed to the erection of a building there for the slow neutron group until the situation as to k is cleared up. Fermi said, "All this matter of Site X appears to arise from the mistaken impression that our experimental work here is finished;" to which Allison replied, "Compton said that our project, rather than Urey's or Lawrence's, has the power of recommending the location of the fast neutron work."

Tuesday, October 13, 1942

Cunningham and Werner prepared a sample of plutonium iodate from a small portion of their stock plutonium nitrate solution by the addition of excess HIO_3 in 4 M HNO_3 . The precipitate was removed by centrifugation, washed with H_2O , transferred to a platinum weighing boat, dried for four hours at 100°C , then weighed with the Salvioni balance. The precipitate was then dissolved and the dried platinum boat was weighed again giving a weight of 1.70 micrograms for the plutonium iodate. The alpha-particle activity of the dissolved iodate was determined and found to be 73,000 alpha disintegrations per minute. Using a specific activity for plutonium of 165,000 alpha disintegrations per minute per microgram, this corresponds to 0.44 micrograms of plutonium element. From this we can calculate the mole ratio of iodate to plutonium to be 3.89, pointing strongly to a valence charge of +4 for the plutonium in plutonous iodate. This is the first instance in which the formula for a plutonium compound has been established. The formula, $\text{Pu}(\text{IO}_3)_4$, agrees with our expectations.

Willard and Turk have continued their study of the adsorption of 94 and fission products on silica gel using neutron-bombarded UHN from the St. Louis sample. They find that the 94 is rather completely adsorbed and can be eluted with 6 N HNO_3 . This suggests that it is the silica rather than the silicates in the Hyflo Super Cel (which is 93% silica gel) that is primarily responsible for the adsorption observed. These experiments indicate a rather substantial separation of the 94 from fission product

10/13/42

activities. They also performed an experiment with alumina using neutron-bombarded UNH from the same source which shows that a high fraction of the fission products are adsorbed and that this is therefore not a satisfactory adsorbent for our purposes.

I held my regular meeting with the Research Associates of my group in my office this evening. I have asked Thompson to join us in these Tuesday evening meetings. Much of the time was spent on further review of the research work that went on during my absence last week. We also discussed the big review session that will take place at the meeting of the Technical Council on Thursday and in which I am scheduled to participate.

Only one day has elapsed and the Technical Council met again. In attendance were Allison, Compton, Cooper, Fermi, Moore, Szilard, Wheeler and Wigner. Wigner opened the meeting by announcing that the situation on k is rather bad. In the discussion that took place, Fermi pointed the expected gain in k should be 4.9%; but the observed increase is 3%, and allowing for 1% due to impurities, this leaves discrepancy of almost 1% for which he cannot account. According to Szilard, Fermi's measurements did not exclude the possibility of a 2% gain by using beryllium, which he advocates using anyway. He then proposed that Cooper contact Brush Beryllium Company to see if beryllium can be produced without interfering with uranium production. Fermi said that he is proceeding with plans for a spherical pile at Argonne Forest. With all materials on hand, a sphere of 4.4-meter radius is possible and will chain-react if the average multiplication factor is 1.044. A sphere of 5-meter radius will chain-react with $k = 1.03$.

Allison then asked the Council members for their reaction to pressure for setting dates. Cooper responded by saying that the design for pile No. 2 must be frozen now, but enough will not be known until the middle of December. Fermi agreed, saying that no one knows the effect of temperature on the center of the pile. Compton gave what he thought is a reasonable schedule. A condensed version of what he said is as follows: Suppose we don't freeze No. 2 pile until the results of No. 1 are known. Suppose No. 1 is ready to go the middle of December, results understood by middle of January.

Set dimensions and freeze design of No. 2. Five months. Hence No. 2 not operating till middle of June. First real opportunity to test effect of temperature, important for helium-cooled production (pile No. 3) plant, which must be run hot. From June 15, eight months to get helium-cooled production plant operating, six months more for operation, autumn of 1944 first useful amounts of material. Lucky on such a program to get anything before January 1, 1945. Question whether we want step-by-step development or parallel development of piles No. 1, No. 2 and No. 3. This was the tenor of the discussion that followed, and it was even suggested by Fermi that external cooling be applied to the pile No. 3 for low power runs, which would thus serve the purpose of pile No. 2. Fermi declared that he has the impression Groves and Conant do not realize the experimental nature of the project, and Compton answered that he told Groves last week that we don't know whether we have a 90 percent or a 10 percent chance of coming through.

The question of providing buildings at Site X for Chicago research was raised once more by Wheeler. He said there is an apparent inconsistency in our attitude. When goal of high production of 94 looks close at hand, we oppose moving to Site X because of proportionately high loss of time; when we are discouraged, as we are at present, then we do not want to look ahead and see that those facilities are provided at Site X which would be necessary in case of a move.

Allison: Council not prepared for decision.

Cooper: If catastrophe in operation of the pile plant, neighboring chemical separation plant would be endangered. Consider the possibility of separation of the two plants.

Compton: We could use a ridge or hill to separate them.

Cooper: Convert material to a transportable form from a pretreating station at each pile and then pipe to the chemical separation plants. (General approval.)

Compton: All division leaders in Council are autonomous actors, to proceed within limits of budget and concurrence of project leader. More delegation of authority and autonomy than in an industrial laboratory. Whitaker at present responsible for our work at Site X,

10/13/42

apart from fast neutron work. Deal through him on pile No. 2.

Fermi: We will need more graphite for pile No. 1.

Compton: I leave that to your discretion. Ruhoff is now our agent for placing orders for uranium metal, oxide and graphite. Hilberry has details in mind on graphite, Doan on metal.

Wednesday, October 14, 1942

Cunningham and Werner planned today for the measurement of the solubility of a number of plutonium compounds, such as the iodate, fluoride, hydroxide, carbonate, phosphate, peroxide, sulfate and oxalate. The plan is to take small samples of the precipitates and let them stand for at least 16 hours in the solutions in which the solubilities are to be determined.

Thompson's experiment on extracting reduced 94 into a chloroform solution of dithizone was completed today, and he finds that no appreciable 94 is extracted into the chloroform. Thus this is not a useful method of purification.

During the last couple of weeks Koshland and Magel have continued their work on an ether extraction methods for isolating 94^{239} from uranium and fission products using UNH which has been bombarded with neutrons at St. Louis. They have studied the effect of HNO_3 concentration on the extraction of oxidized 94 into the ether phase and the accompanying extraction of a small quantity of fission products into the ether phase. They find that the 94 can be removed from the ether by shaking the ether layer with several small volumes of water saturated with SO_2 which reduces 94 to its lower oxidation state. The behavior of the fission products in this step will be investigated.

Our secretary, Mrs. Kvidera, is leaving us because of pregnancy, so we are in the process of looking for a replacement. Today Perlman and I interviewed an attractive 22-year-old girl, Edrey Smith, who graduated from Oberlin College this spring and will soon finish a secretarial course

10/14/42

at Moser Business College here in Chicago. She lives with her parents in the Beverly Hills section (9514 Damen Avenue), a few miles from the Laboratory in a southwesterly direction. We are very favorably impressed and immediately decided to offer Miss Smith the position. Although she seems interested, it is clear that she is somewhat non-plussed by the guard arrangement, our unusual looking laboratory with its strange odors and unfamiliar looking equipment and perhaps by the appearance of the people she saw. This is indeed a strange environment to her, far from the business-type atmosphere that she imagined she would work in now that she has prepared herself as a secretary. She will finish her secretarial course in a week or two and then plans to take a short vacation before starting to work. We are hopeful that she will decide to come with us, despite our unusual work atmosphere, because she will obviously add so much to the place.

My last letter to Heydenburg at the Department of Terrestrial Magnetism, dated October 2, carried the promise of sending him some pure 94^{239} in compound form; and today I wrote him that the sample is on the way. It is the sample that Cunningham and Werner deposited on a platinum sheet for him last Saturday. I said that there are between five and seven micrograms of 94^{239} in the sample, an amount which has been determined by taking a rough measurement of the alpha-counting rate.

I wrote to Hamaker in Berkeley, saying that I am sending him Breslow's notebook at Hamilton's request. From it Hamilton hopes to glean some details of how to concentrate radioactive isotopes by the Szilard-Chalmers process.

Robert Lee Wells and Albert Foster York, the two attorneys associated with the Met Lab, are seeking to file a patent, in my name on 94^{239} . I informed Kennedy in Berkeley by letter, with copies to Wahl and Latimer, that the patent, according to them, is entirely a "chemical patent" based upon the discovery of the oxidation and reduction principle for separating 94; that in their opinion there is nothing basically patentable in the discovery of the radioactive and fission properties of 94^{239} . I concluded my letter by writing, "I raised with York and Wells the question of your

10/14/42.

name being included on the chemical patent and they decided to leave this decision to you. If you feel that you contributed to the chemical ideas and/or operations in the development of the oxidation and reduction separation principle, then let me know and they will include your name. This seems fair enough to me."

Our laboratory space on the fourth floor of Jones Laboratory is now fully occupied with my group of about 20 scientists working on a broad spectrum of problems involving the chemistry of element 94 (Figure 19).

Thursday, October 15, 1942

Thompson commenced experiments today to investigate further the separation of $94^{(r)}$ (94 in the reduced state) from $93^{(r)}$ (93 in the reduced state) by precipitation with 8-hydroxyquinoline (oxine), a method that was investigated by Willard and Turk last month.

Today was an exciting day for me. In the afternoon I participated in the last part of an all-day conference, held in Room 209 Eckhart Hall, in which the Technical Council summarized for General Groves, Colonel Nichols, Colonel Marshall, Murphree, Oppenheimer and some outside reviewers from the du Pont Company and Stone and Webster, the whole planned Project program for piles, chemical extraction plants, etc. A number of other Project leaders were also present. I shall describe here what went on during the whole day meeting, relying on the minutes (which were available later) for information on what went on in my absence. The last four meetings of the Technical Council were, in a sense, held in order to decide on the future program to be presented today; it is for this reason that they were held on such a frequent time schedule.

The morning session was attended by Allison, Cantril, Compton, Cooper, Doan, Fermi, Hilberry, Moore, Spedding, Stearns, Steinbach, Szilard, Wheeler, Whitaker, Wigner, Wilson and Zinn from the Met Lab. Outsiders were Chilton, Cole, Gary, Grafton, Groves, Klein, LaCrosse, Marshall, Murphree, Nichols, Oppenheimer and Pardee. Unlike many of the Technical Council meetings that preceded it, the conference was controlled

10/15/42

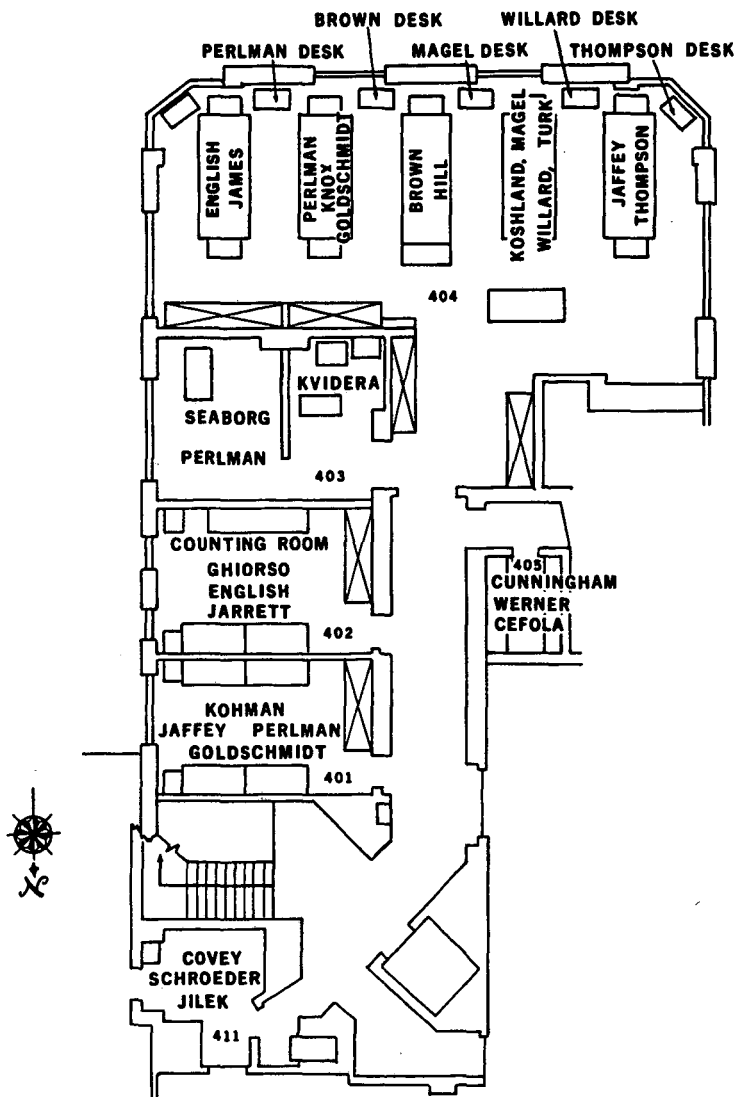

XBL 768 - 3256

Fig. 19 Space occupied by individual members of our Group, early October 1942. (XBL 768-3256)

10/15/42

and not so many controversies erupted. Council members and other Project people presented concise summaries of present situations and plans for the future. Although the conference was intended to be an information meeting for the outsiders, it also had the salutary effect in uniting the thinking of the Council members.

Fermi was the first to speak. He stated his case for Pile I (No. 1) to be erected in the laboratory at Argonne Forest. I will repeat the secretary's minutes of his talk because of their significance: Argonne Forest experiment to get first sustaining chain reaction. Experiment on uranium metal in last few days at Chicago gives value of the multiplication factor k lower than expected, hence it will be necessary to increase size of pile 10% to 15%, which will require 50% more material. In order to economize on material, the pile will be built into a spherical shape to a diameter of 26 feet. If the available material runs short and the critical diameter cannot be achieved, then more material must be procured. It will be wise to have this additional material on hand to avoid a possible delay. The intention is to assemble the structure by the end of December and to draw the first conclusions then. At this time we will be in a position to determine the critical dimensions if they fall short of the actual dimensions. Test critical size--that chain reaction will go. Test controls; get reliable information as to temperature effect on k . A 10°C rise in temperature will be sufficient to detect change in the multiplication factor of 0.1 percent per 100°C ; a smaller change than this is unimportant. Then test power production by flashing the pile perhaps to 1,000 kw for a time short enough not to make materials too radioactive.

Compton displayed a photograph of the Argonne Forest building that would contain Pile I and was followed by Volney C. Wilson to explain how this first pile is to be controlled. According to theory, a chain reaction will continue to build as long as k is greater than unity. Before completing the erection of Pile I, four cadmium or boron strips will be inserted, three for safety and one for control. At the time of operation, three strips will be withdrawn all the way. The fourth strip will be pulled out beyond the zero point ($k = 1.0000$) until the reaction builds up to the desired level, at which time it will be pushed back in to the zero point to maintain the chain reaction at a constant level. The controls will be managed by an operator at first when starting a run

10/15/42.

in order to secure the desired operating level; thereafter an automatic electronic device will maintain stable conditions.

There was a question or two about flashing and temperature rises, and then Whitaker took the floor to outline the plans for a pilot plant (Pile II) at Site X. The pilot plant, as conceived, will be cooled on the surface and run at several hundred kilowatts. Its purpose is to provide experience in operation, use of controls and temperature stability tests at several power levels. It is estimated that thirty days of operation will produce enough ⁹⁴ to test chemical separation methods. As for the structure of the pile, it will be filled with helium, be 25 feet on a side, and be composed of 40 tons of uranium metal and 800 tons of machined graphite. It will be operated for a month at maximum energy (250 to 500 kw). At the conclusion of this period, the safety rods will go into place and the uranium material will be removed. If the 40 tons of metal are available by March 15, then the structure will go into operation April 15, operate to May 15, cool to June 1 and be disassembled. "Those of us," he said, "who are accustomed to work with small budgets have proposed the elimination of a pilot plant, building a full-scale production pile instead, and to operate it for a time as a pilot plant. The purpose of the pilot plant is to gain experience in the operation of a plant at a temperature much higher than that to be reached in the Argonne Forest experiment." There followed a discussion of the maximum size a pile might be in order to have a building to accommodate it. Fermi quoted a figure of 25 feet diameter for an all-oxide pile and 20 feet for an all-metal pile.

Compton then reviewed the schedule proposed so far: Argonne Forest pile (No. I) to be built December 15, pilot plant (No. II) in operation April 15, and October 1 as the earliest estimate for the operation of a helium-cooled pile (No. III). Wheeler got up and described the main features of the helium-cooled, production pile called Pile III. By way of introduction he said that there are two alternatives for cooling Pile III: either cool from outside and remove uranium periodically from the pile, or send cooling medium into pile to cool metal in situ. Little consideration has been given to the first alternative because of mechanical difficulties. For the second alternative, the choice of cooling fluids is much limited.

10/15/42

Helium gives no chemical reactions and is only substance that does not absorb neutrons.

He described Pile III as consisting of lumps of uranium sliced into plates with space between for the circulation of helium. A series of lumps would be placed along a channel in graphite, there being about 400 of these channels running vertically. The hot helium would go to a heat exchanger, then to compressors, then to an after-cooler, then back to the pile at room temperature. The major problem is that uranium would eject fission products into the helium; and, therefore, up to ten feet of water would be required for shielding. To run the pile at a lower rate than that for which it is intended requires much less external power. For instance, reducing the heat output of the pile by a factor of 10 would reduce the pumping power by a factor of 100 to 1,000. Thus it is possible to run a pile as a pilot plant before the arrival of auxiliary equipment. The approximate amounts of material required for the pile were given as 70 tons of uranium metal, 800 tons of graphite and 560 cubic feet of helium, to be encased in a spherical steel shell 30 feet in diameter.

Wheeler, in discussing the problem of erecting Pile III, likened it to the problem of racing the Germans to the North Pole. A too-lightly laden sledge (insufficient uranium in the pile, insufficient protection against radiation) will lead to breakdown on the way; whereas a too-heavily laden sledge (too much time taken in applying large and complex auxiliary equipment) will slow down progress and result in loss of the race. "The problem of constructing the helium-cooled plant as we see it now can be compared with a sledge journey for which there is a considerable safety margin between the minimum requirements for safety needed for operation and the maximum requirements for practicability."

In the discussion that followed, Wigner pointed out that a liquid-cooled plant for Pile III is speculative, but it has the advantage of giving big production and probably could be ready before a helium-cooled plant. Compton commented that there has not been an adequate opportunity for the engineering development of either the water-cooled plant or the bismuth-cooled plant. Szilard replied that one cannot say whether or not bismuth would be a proper cooling agent and that tests are needed. But if it will work, a bismuth-cooled pile can be built quickly, as a minimum

10/15/42

amount of equipment is needed. It depends on how much 94 one wants. He said, "Fifty kg of 94 is enough to astonish, and perhaps even irritate, the Germans; but, if we want to win the war, I would personally estimate that we shall have to produce a ton of 94. We can produce one kg of 94 per day for every 40 tons of uranium and 300 tons of graphite; for a bismuth-cooled pile it might be necessary to have 1,000 tons of graphite." He went on to describe the merits of the system and had a ready answer for every question. The meeting adjourned until after lunch.

There were two sessions of the conference in the afternoon, and the composition of the attendees was somewhat different from the morning. Those attending the first session were Allison, Chilton, Compton, Cooper, Doan, Fermi, Gary, Grafton, Groves, Hilberry, Klein, LaCrosse, Marshall, Moore, Murphree, Nichols, Pardee, Steinbach and Wheeler. Compton opened the meeting by saying he would present time-schedules as now contemplated, assuming that ample uranium and graphite are on hand when required. Pile I will be built by December 15, with testing January 1 and power flash January 15. When Groves asked why the delay until December 15, Fermi said, "The oxide will not be on hand until December 1. We also must transport 500 tons 20 miles." Groves said, "We can move 500 tons in a day if necessary," and Fermi replied, "Offer accepted." Pile I requires 6 tons of uranium metal and 60 tons of uranium oxide.

Pile II will be built and operating by April 15, and then torn down June 1 for extraction of 94. The requirements are 40 tons each of uranium and uranium oxide. The chemical extraction plant will be tested between April 15 and June 1, with operations commencing June 1. Pile II will be rebuilt for further testing using some of the previous materials. Allowing time for radioactive decay, it should be ready August 1.

Pile III, the helium-cooled plant, will be completed about November 1943 and operated one month as pilot plant. It will then go into full operation for 90 days until March 1, 1944, producing 100 grams of Pu^{239} per day, rather than 40 grams per day, giving approximately ten kilograms. The ten kilograms of 94 will then be separated in the chemical separation plant, completing the job by May 1, 1944. Pile III will then be reloaded with its second batch.

Pile IV, cooled by water, diphenyl or possibly bismuth, would be constructed by November 1, 1943, using 2,000 tons of graphite and 200 tons of

10/15/42

uranium, and would have a daily output of 400 grams of 94.

Compton's scheduling evoked many remarks about the availability of materials and the possibility of eliminating Pile II if Pile III can be built in a hurry. Fermi, concerned about his responsibility in getting Pile I to operate by January 1, said, "The schedule is one which we may be able to keep if we are lucky. There is a 40 percent chance it will go and a 60 percent chance it won't go. If it doesn't, then additional material will have to be added—perhaps as much as 50 percent more material—with a consequent delay.

Groves brought up the subject of secrecy. He emphasized the need for compartmentalization of knowledge and said we have no need to know about the Urey and Lawrence projects. We are to preserve notes, watch our briefcases and guard our conversations on telephones, which may be tapped. Toward the end of the session, LaCrosse started an argument by saying that no good will come of putting one engineer with each "doctor" but that all engineers should be put into one room, with the information funnelled in to them. Compton was not happy with this arrangement, saying, "Men in a laboratory are not content to have developmental work taken out of their hands—they want to control the direction of the work. There is no possibility of satisfactory design without intimate contact between engineers and scientific men. Therefore we want to arrange to have the engineering design work and men at Chicago."

LaCrosse: You seem to feel that chemical engineers are what you need for this development work. I am inclined to feel that your present needs are more along the lines of mechanical engineering.

Groves: Process engineers should go between physicists and final engineers.

Murphree: It is more than a question of engineers simply taking over a completed idea. There has to be intimate contact, that is, both engineering and physical phases must be worked out together.

Fermi: It is necessary for physicists to work with process engineers—and in same room.

Murphree: Rather different rooms, going back and forth.

LaCrosse: Let the boss take responsibility for the design and let him consult with a physicist, but don't have both groups of people in the same room. Let the engineers keep their doors open.

10/15/42

Groves had the last word. He said, "The same problem of collaboration has come up on every project we have undertaken. There should be no barriers to collaboration between the two groups."

I cite the above controversy because it exemplifies the strong feeling that now exists in the physicist, chemist and engineer. Each of us wants to be able to contribute to our fullest measure without being circumscribed by others, especially by those we feel do not have the knowledge, competency or vision of what ought to be.

The second session of the afternoon was attended, in addition, by Boyd and me. I was the first speaker on the program; and, after I finished, Cole, Coryell and Cantril came in. In summary, I had this to say after describing how tracers are used to study chemical reactions: There are three or four methods that have been devised for the separation of 94 from uranium and fission products. Microchemical work indicates that the processes will work at the concentrations to be used in the actual separation plant. Element 94 resembles uranium in that there are two oxidation states. The lower state is probably 94^{+4} and the upper state 94^{+6} . Insoluble compounds are like those of rare earths and are characteristic of the lower state, whereas soluble compounds are generally characteristic of the upper state.

One method of separation, I said, is based on the principle of oxidation and reduction, using a wet process with HF. A second method, based on the same method, uses the ether extraction of nitrate. There is the possibility of continuous extraction employing this process. Method 3, the dry fluoride method, consists of (1) treatment with HF, (2) treatment with F_2 at low temperature to remove uranium and 93, and (3) treatment with F_2 at high temperature to remove 94. Method 4 utilizes peroxide (H_2O_2) with 92, 93 and 94 precipitating. All four methods seem to be capable of effecting separation. The question is, what choice should we make at this time? There is the possibility of combining one procedure with another. In many ways, dry fluoride is the neatest method: there is good separation and one can work at a safe distance from radioactivity, but there is a problem of adequate material and equipment.

The next speaker was Cooper, who discussed the engineering aspects of a chemical extraction plant. He said that the job would be quite simple if it were not for the problem of radioactivity. "But we have to make

10/15/42

equipment so it will work without maintenance behind six to eight feet of concrete. There are three divisions to the problem. Presumably we will receive the active material in the form of metal, possibly coated, probably encumbered with graphite. The volatile radioactive fission products will be tied up in the metal. After a month to allow for radioactive decay, the material that has volatilized must be diluted with air to a point where it is safe for workmen to breathe in the vicinity. The uranium in the pile would be dissolved or burned to a powder at the site of the pile and then sent through a pipe to the chemical separation plant some distance away. Here the material would be concentrated in the second phase of the operation to a relatively small volume. The plan is to handle one ton per day (or perhaps more in view of the recent upward revision of tonnage of uranium required for the pile). The largest tank employed will have a capacity of 3,000 gallons, with a height and diameter of about five to eight feet. Tanks and associated equipment will be in barriers of concrete, or lead and concrete. The third step of completing the separation would be almost a laboratory type of procedure."

Cooper went on to talk about the philosophy of design: Line of tanks and filter. Tanks for non-radioactive materials outside barrier. Gravity flow as much as possible to cut down problem of pump maintenance. Scheme in process of being drawn. Probably will be able to start operations in June. Perhaps a month of trial with non-radioactive materials. Start with 2,000 tons of uranium, each ton in something like 3,000 gallons of solution. Amounts of precipitate so small that carriers will be added to co-precipitate. By November 1 preparations for detailed design should be in hand.

Groves: Material problems? Fluorine?

Cooper: Fluorine supply not serious, but hydrogen peroxide may be a greater problem. Might need as much as ton of fluorine per ton of uranium.

Compton: What is the amount of peroxide used at Port Hope?

Seaborg: The problem is more that of obtaining material for tanks in which to put the hydrogen peroxide than it is a problem of securing the hydrogen peroxide itself.

Groves: I approve of gravity flow. Excavation and fill much more satisfactory than pumps.

10/15/42

Compton: Eventually, it is a problem of turning 94 into metal.

Seaborg: Development proceeding along that line. We feel that any process that works for uranium will work for 94.

LaCrosse: How far between reactor and separation plant?

Cooper: Separation plant big enough to handle several production plants. Problem of protection. Possibly a mile separation.

LaCrosse: Gravity flow?

Cooper: Not a serious problem; air pressure will maintain a flow to the chemical separation plant.

Cole: Many radiation hazards. There will be a greater concentration of radioactivity than ever before experienced.

The remainder of the session was devoted to a discussion of safety from the hazards of radioactivity. Klein was disturbed that he has been asked to put the chemical separation plant eight miles away from the other areas, and yet Site X is not big enough for such separation, and farm houses are within that radius. He also questioned Cooper's estimate of using a separation of one mile with a ridge in between. The eight-mile limit, according to Hilberry, was chosen because it includes a health factor and a factor of protecting the laboratory from radioactive substances in the wind, the latter being the more important.

Groves asked about the effect of the ridges, as they are 200-300 feet high. In Cantril's opinion, they would help to protect against radiation but not gases. Klein then drew a sketch of the proposed Site X. The pile would be situated in the valley between two ridges and five miles away from laboratory and administration buildings and village, which would occupy other valleys. The whole working area would be bounded by a river on one side and an artificial barrier on the other, with the village being on the outside of the barrier. When Marshall pointed out that the prevailing wind is from the pile toward the laboratory and village, there was a suggestion that their locations be interchanged, but this was quashed by Groves who said that if this were done the L&N Railroad right-of-way would have to be purchased.

It is interesting to note that some of the engineers now refer to the pile as a "reactor." Heretofore they have favored "power plant." I don't think I have heard Fermi or the other physicists use the term.

10/15/42.

Today the newspapers state that the Japanese have landed heavy reinforcements on Guadalcanal Island, and it looks as though there will be another big battle there.

Friday, October 16, 1942

Cunningham and Werner today set up a number of solutions (each with suspended plutonium precipitates) in order to measure the solubilities. In each case the precipitate was formed by adding the proper reagent to a solution containing about 0.1 microgram of plutonium. In each case the precipitate and solution in the microcone was placed inside a 2 mm diameter and 6 mm long sealed glass tubing in order to prevent water evaporation, and the experiments were set up to stand overnight or longer. The plutonium compounds included the oxalate, peroxide and carbonate and the solutions included various concentrations of oxalate, water, acid, carbonate and so forth.

Now ready to test his chloride volatility method with active material, Jaffey is starting an experiment with U_3O_8 prepared from some neutron-bombarded UNH, a part of the large neutron bombardment at St. Louis. He plans to measure the distribution of beta and gamma activity from the fission products following chlorination with Cl_2-CCl_4 . He treated the mixture with these gases at $400^\circ C$ for about an hour and finds to his surprise that most of the fission product beta and gamma activity has passed over with the volatile UCl_5 . It appears that this method of separation is not successful because even non-volatile tracer activity is being swept over with the volatile UCl_5 .

Bob Stone, in discussing with me his new department dealing with health problems at the Met Lab, has mentioned that he is trying to recruit Waldo E. Cohn, a mutual friend we knew at Berkeley who received his Ph.D. in biochemistry there in 1938. I wrote to Waldo today at the Huntington Memorial Hospital, Boston, where he is working at present, and encouraged him to switch jobs, saying that I consider our work here to be the most interesting and important I have ever engaged in.

10/16/42

The siege of Stalingrad took a reverse, and the Nazis pushed the Soviets back a bit.

Saturday, October 17, 1942

The "Report for October 1-15, 1942, Chemistry of 94, University of California and University of Chicago" (No. CN-299) is ready today. In summary, the report says that Cunningham and Werner, using ultramicrochemical techniques, have made a check determination of the half-life of 94^{239} by weighing the oxide, assumed to be PuO_2 . The value for the specific activity, 163,000 alpha disintegrations/min/microgram is in good agreement with that previously reported, that is, 167,000 disintegrations/min/microgram. A plus-4 value for the lower oxidation number of 94 has been determined by weighing plutonous iodate. English reports his and James' search for gamma rays from 94^{239} using high purity material and a Geiger-Müller counter; the finding of roughly 0.1 percent as many gamma rays as alpha particles indicates there is no appreciable amount of fine structure in the alpha emission. Cefola, using ultramicrochemical methods, reports that he has verified that a preformed lanthanum fluoride precipitate satisfactorily removes plutonium in the concentrations anticipated in large-scale separations by the Wet Fluoride Method for separating 94.

Koshland and Magel report that in studying the solvent partition method for separating 94, they find that the presence of free nitric acid is necessary to obtain yields of oxidized 94 of 90 percent in the ether layer. Since increasing acidity increases the amount of fission products in the ether layer, experiments have been conducted to determine the optimum acid concentration for separating 94 from fission products. Willard and Turk say in their report that they have conducted further experiments on the adsorption method for separating 94 and find that an appreciable fraction of 94^{239} is adsorbed from 10 percent uranyl nitrate solution by Hyflo Super Cel (HSC) for a concentration of 94 as high as one part in 7,800 parts of uranium, that HSC adsorbs columbium much more efficiently than it does zirconium, that columns of silica gel are similar to HSC columns in their ability to selectively absorb 94 from solutions of uranyl

10/17/42 .

nitrate and fission products, and that activated alumina is not as effective as HSC in this respect.

In the Berkeley part of the report there is a section by Garner on "Volatility of 94 Compounds," a section by Sheline and Garner on "Oxidation Reactions of 94" and a section by Sheline on "Wet Fluoride Method for Separating 94."

Today was beautifully clear and warm. I walked over to Ingleside Avenue to explore our new chemistry building (Figures 20 and 21) and inspect the layout for our office and laboratory rooms. At the rate the interior is being completed, it will not be long before the laboratory fixtures and furniture are moved in and we can occupy the premises.

Sunday, October 18, 1942

Today's headlines in the Sun tell about the R.A.F.'s biggest daylight raid. In the U.S. the House voted to draft 18 and 19-year-olds, lowering the draft age from 20.

Monday, October 19, 1942

Cunningham and Werner made alpha counting measurements on the supernatant solutions in the experiments set up last Friday and find for plutonium carbonate a solubility of 43 mg of plutonium per liter in water, 72 mg of plutonium per liter in 1 M Na_3CO_3 , and 140 mg per liter in 2.5 M Na_2CO_3 .

Today Jaffey tried a volatilization experiment using $\text{Cl}_2\text{-CCl}_4$ on 10 mg unirradiated U_3O_8 and he finds that about 40% of the non-volatile UX_1 is swept over with the volatile UCl_5 . He tried another experiment with a sample of U_3O_8 containing the fission products (prepared from UNH from the St. Louis bombardment) in which glass wool was interposed between the furnace and the receiver of the volatile UCl_5 . He again used $\text{Cl}_2\text{-CCl}_4$ at 400°C , in this case for about a half-hour, and finds that fission products

10/19/42

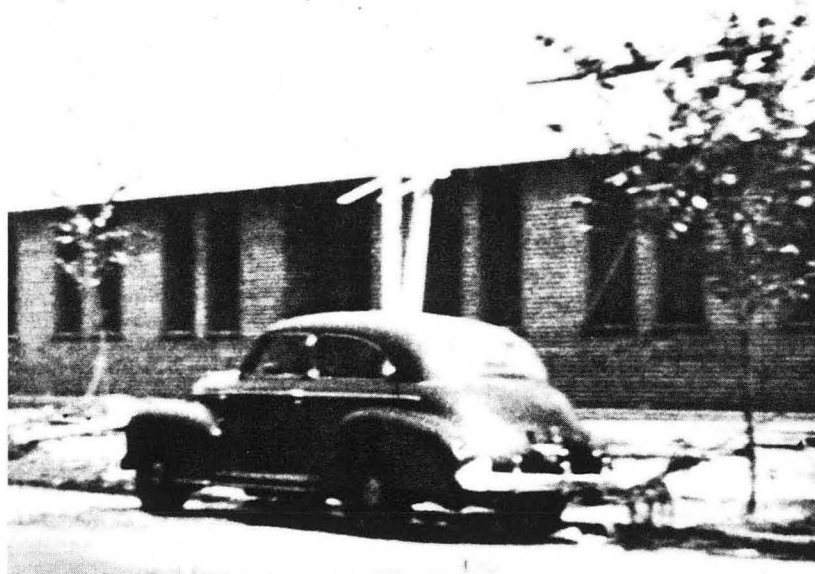

Fig. 20 New Chemistry Building under construction, October 1942. Facing east from Ingleside Avenue. Main entrance in view beyond top of car. (XBB 768-7460)



Fig. 21 New Chemistry Building under construction, October 1942. Facing southeast from corner of 56th Street (left) and Ingleside Avenue (right). (XBB 768-7461)

10/19/42

are in large part volatilized and an appreciable fraction captured by the glass wool. These experiments do not seem too hopeful as an indication of a chemical separation method.

During the last few days Perlman has completed a series of experiments to determine the amount of fission product activity that accompanies the 94^{239} extracted by the Wet Fluoride Method. He used neutron-irradiated UNH from the St. Louis bombardment and hence this is equivalent to three months after the shutdown of a chain-reacting pile. His experiments show that the precipitation of lanthanum fluoride from 5% uranium solution should be carried out in the presence of zirconium, columbium and strontium holdback carriers to minimize the precipitation of these fission product activities. This is particularly important for the second fluoride precipitation because, as the process is now envisaged, the first fluoride precipitation will be carried out when the 94 is in the oxidized state, a form in which it does not co-precipitate; after the first fluoride precipitation, the 94 is to be reduced and then co-precipitated with a second lanthanum fluoride and the holdback carriers aid in preventing the co-precipitation of zirconium, columbium and strontium at this step. Perlman's experiments indicate that the amount of fission product gamma activity accompanying the crude 94^{239} fraction in this second lanthanum fluoride precipitation is only about 0.5% of the total fission fission product gamma activity present in the initial uranium solution.

I received a note from Gofman about the 94^{239} sample I gave him during my trip to Berkeley. It said: "Perhaps we can throw some light on the discrepancy you have observed between amplifier weighing of samples and dilution weighing. The sample which you gave us labelled 10 micrograms really has only 4.6 micrograms. Either your microchemists are kidding you or they are very thrifty."

The Technical Council met this afternoon as usual, but only six were present: Cooper, Fermi, Moore, Szilard, Wheeler and Wigner. Fermi and Wigner engaged in a discussion of the multiplication factor. They agreed that for an eight-inch lattice the value of k continues to improve as the amount of metal is increased. For a

10/19/42

given lattice spacing the optimum arrangement of the metal may very well be a plant type of structure; but the optimum lattice probably is one with a smaller spacing in which lumps are employed; and the best value for k is probably 1.07 or 1.075.

Considerable attention was paid to the coating of uranium, the investigation of which is going on in several outside laboratories; it was recommended that John Howe of Burton's group be given the responsibility for coordinating this work. Szilard expressed the opinion that work should be done on plating for both the helium- and water-cooled systems. This was followed by a general discussion of the use of cyclotrons: where bombardments for the fast neutron and other work could be made and who would be in charge. Szilard said that the Illinois cyclotron could not be used because there is a man there with a German wife, and Wigner wondered about the two Nazi workmen at the Ann Arbor cyclotron, to which Fermi replied that we should take over the Ann Arbor cyclotron in a big way or not at all. The council agreed to recommend that Burton and Coryell be sent to Ann Arbor with their groups, under the general supervision of James Franck. Wheeler brought up the subject of secrecy at the Thursday night meetings of the Research Associates. Fermi questioned how much information is leaking outside the Project and Wheeler agreed to contact physicists off the Project to learn the extent of it, if any.

In the siege of Stalingrad the Soviets are holding firm.

Tuesday, October 20, 1942

Cunningham and Werner, continuing their measurements on the supernatants of the solutions set up last Friday, find a solubility for plutonium oxalate in 1 M $K_2C_2O_4$ of 700 mg plutonium per liter. Today they also set up experiments like those of last Friday to test the solubilities of plutonium hydroxide in various solutions.

I wrote to Gofman, in part responding to the note I received from him yesterday: "I am enclosing my write-up of the U^{232} work, which I would

10/20/42

like to have you read and make any suggestions or corrections which appear to you. Be especially careful to check all the yield figures, which I calculated rather hastily. Has Kennedy measured the range of the alpha-particles yet? If he has, we might include this information, stating that it is Kennedy's, of course.

"We now apparently have an agreement between the amplifier weighing and the dilution weighing of samples. The microchemists cannot explain why your sample was so small, but this is probably not surprising in view of the haste with which they prepared the sample for me before my departure. We could probably supply you with some more material if you needed it, but this would take some time, since our material is now spread throughout the lab in some few dozen fractions. Perhaps Wahl can spare you a little material, or perhaps the 4.6 micrograms will be sufficient for your purposes.

"I would be interested in learning what you obtain for the ratio of the slow neutron fission cross section of 49 relative to that of 25, so that I could see how it checks with the work of the fellows here."

At the regular meeting with my group's Research Associates in my office this evening I described the review session of the Technical Council last Thursday. We discussed research progress, including the interesting results from the experiments of the ultramicrochemists. There was also discussion of the discrepancy between Berkeley's and our measurements of the 94 content of the sample we gave them.

Today's news indicates that U.S. warships have joined the battle of the Solomons and destroyed Japanese ammunition dumps.

Wednesday, October 21, 1942

Continuing their measurements of plutonium solubilities in the solutions set up last Friday and yesterday, Cunningham finds the following solubilities of plutonium compounds in terms of mg plutonium per liter: oxalate in water, 2 mg per liter; peroxide in water, 16 mg per liter; hydroxide in water, 1.8 mg per liter; hydroxide in 0.4 M K_2SO_4 , 1.7 mg per

10/21/42

liter; hydroxide in 1 M $(\text{NH}_4)_2\text{SO}_4$, 1.1 mg per liter.

Thompson's experiments during the last week with oxine as precipitant employing 94^{238} and 93^{239} as tracers show that when Ce^{+3} , Ce^{+4} and UO_2^{+2} are used as carriers, precipitates formed by the addition of oxine (which precipitates UO_2^{+2}) at approximately pH 4.0 will contain at least 95% of the 94 present, while only about 15% of the 93 will be carried down. Evidence was obtained indicating that the holdback carrier Ce^{+3} is necessary in order to obtain good separations.

Thompson is beginning experiments to investigate the co-precipitation of $94^{(r)}$ with zirconium phosphate. The fact that zirconium phosphate is insoluble in acid solution might make it a suitable carrier for $94^{(r)}$, whose phosphate has been shown by Cunningham and Werner to be insoluble; separation from acid solution is particularly attractive because many of the fission product phosphates would be soluble.

Laitinen sent me a letter in behalf of the American Chemical Society, thanking me for speaking before the University of Illinois Section on October 1. He also enclosed a check to cover my expenses.

Goldschmidt is leaving the Met Lab this week, and we are all sad to see him go. Besides being a first-rate scientist, his ebullient spirit has been a great morale booster for our group. He told me that the Canadian National Research Council is establishing a nuclear laboratory somewhere in Canada, and he will be going there soon to join his old French colleagues, Hans Halban and Lew Kowarski. We wish him success in his new assignment. Our group plans to have a small going-away luncheon for him tomorrow.

Thursday, October 22, 1942

Cunningham and Werner set up solubility experiments for plutonium phosphate and plutonium iodate in a number of solutions. They are making the measurements on plutonous phosphate because of Thompson's growing interest in co-precipitating plutonium with an insoluble phosphate as a

10/22/42

potential method for separating plutonium from uranium and fission products.

Thompson is starting to investigate the possibility of co-precipitating $94^{(r)}$ from slightly acid solution with the insoluble precipitates of ions like Th^{+4} , Zr^{+4} and Ce^{+4} formed with meta nitrobenzoic acid. Today he has co-precipitated $94^{(r)}$ with lanthanum phosphate, using concentrated NaH_2PO_4 solution under conditions where zirconium phosphate does not precipitate.

About one o'clock this afternoon, all the members of my group, including the du Pont men, R. S. Apple, Donald Webster, L. C. Peery and P. S. Vincent, as well as Covey and our three laboratory assistants and helpers Roy Schroeder, Walter Jilek and Wallace Vogwill, and my secretary Myrtle Kvidera, accompanied Goldschmidt, Iz and me to the banquet room of the Hutchinson Commons. This afforded an opportunity for all of the scientists in my group to assemble—Research Associates Perlman, Brown, Willard, Cunningham, Cefola, English, Ghiorso, Kohman, Magel, Jaffey and Thompson, and Research Assistants Knox, James, Koshland, Hill, Turk, Werner and Jarrett. There were 29 of us in all, including Goldschmidt, quite an increase since the two of us, Perlman and I, arrived in Chicago just six months ago; I believe we will need to continue to add many more before we can successfully carry out the difficult assignment that we face. We sat at a large table already set up for us, where food was then served. After lunch, I gave a little speech and presented Goldschmidt with a leather brief case, which had been purchased (for \$17) with contributions from all of us, as a token of our esteem and friendship. I also presented him, as a gag, with a small replica of a pig feeding trough to suggest he has worked in our laboratory like a pig. He gave a warm response and then we all drifted back to Jones Laboratory.

The U.S. Navy lost two destroyers at Guadalcanal, but it is believed that all personnel were saved.

Friday, October 23, 1942

There was a sudden drop in temperature today to 30°F. The morning was overcast, but then it cleared and there was a light snow.

Covey, with the help of lab helpers Vogwill and Jilek and lab assistant Schroeder, have finished recrystallizing and purifying the Mallinckrodt UNH and are packing it into bottles for storage. We are still using the attic and the roof of Jones Laboratory for this operation. We expect to ship another 300 pounds of the purified crystals to St. Louis next month for neutron irradiation in the cyclotron there.

Harrison Brown and I signed papers for patent case S-58 entitled "Fluorine Process for Separation of Materials" covering the Dry Fluoride Volatility Process for separating element 94 from uranium and fission products.

Saturday, October 24, 1942

Another du Pont man, W. Q. Smith, is joining Charles Cooper's chemical engineering group. He will probably serve in a group leader capacity and will be involved in a lot of liaison work with my group.

Bombers supporting U.S. forces in the Solomons sank a cruiser, a destroyer and eight transports or cargo ships.

Sunday, October 25, 1942

At my suggestion Magel has shifted his research emphasis. He and Cefola are now trying to develop methods for the production of plutonium metal, a form in which it will have to be ultimately produced to make it suitable for use in a nuclear weapon. Using some of Cunningham and Werner's pure stock solution of plutonium (94^{239}) nitrate, they evaporated a quantity containing about one microgram of plutonium on a small quartz

10/25/42

disk and heated this until the yellowish-brown oxide was produced. When this oxide was treated with hydrogen at 450°C, a black product was formed which was stable in air at room temperature. When this black reduced material was treated with 2 N HCl, observations under the microscope showed that there was no evolution of gas, indicating that this cannot be metallic plutonium. Treatment of the black material with oxygen gas at 450°C changed the color back to the yellowish-brown and they find that this cycle of reduction and oxidation can be repeated at will. In another experiment using essentially pure plutonous (94^{239}) sulfate, they carried on electrolysis using a mercury cathode. Although appreciable plutonium passed into the mercury, it is doubtful that this indicates the production of metallic plutonium.

Completed today was the bombardment of our 300 pounds (136 kg) of UNH with the neutrons produced by the irradiation of a beryllium target with deuterons for a total exposure of 100,000 microampere-hours at the cyclotron at Washington University in St. Louis. This second large bombardment started on September 5, 1942, and we are giving it the designation Chicago II.

Monday, October 26, 1942

Thompson has found that $94^{(r)}$ co-precipitates and $93^{(r)}$ does not at a pH of about 5.5 (adjusted by the addition of NH_4Ac) with zirconium carrier when meta nitrobenzoic acid is added to the solution. The presence of La^{+3} in solution as holdback carrier apparently aids in preventing the co-precipitation of $93^{(r)}$.

Two of the organic reagents that Thompson would like to use for investigation of the precipitation reactions of 94, including possible use for separation from element 93, are phenylarsonic acid and sebacic acid. Unfortunately, Eastman Kodak Company cannot supply us with these reagents at this time; so I appealed to Henry Gilman, professor of chemistry at Iowa State College where Spedding has his chemistry and metallurgical group, to synthesize some small samples. I expressed my appreciation and

10/26/42

assured him that the problem for which the reagents will be used is a very important one. In response to his request, I mailed Joe Hamilton at Berkeley a copy of the Goldschmidt-Perlman report on fission products.

Baumbach knows for certain now that Paramount Studios will not give him a leave of absence longer than three months to come with us. In my letter to him today I said that it is barely possible the Met Lab might extend an offer for this period because about a dozen persons have come on short leaves of absence and at the expiration of their leaves have stayed with us, to a man. I included Thompson among them saying he is now certain that he is not returning to his former job with Standard Oil. I also expressed my pleasure at seeing him and his wife Nathalie when I was in Los Angeles early this month.

There was a meeting of the Technical Council today, with Allison, Compton, Cooper, Fermi, Moore, Wheeler and Wigner attending. Cooper announced that Crawford Greenewalt of du Pont will visit the Lab tomorrow. Allison read two memoranda, one from Burton asking for a 4" by 4" hole sunk about a foot into the vacuum wall of Pile II, and one from me. My request was somewhat more feasible. My memo said:

"(1) Space should be left adjoining Pile II in which to place thorium for the production of U^{233} . An amount of U^{233} of the order of milligrams to grams will be useful for the further study of the neutron and spontaneous fission properties of U^{233} . Likewise it is desirable to practice on the extraction of U^{233} from larger amounts of thorium than have been used so far. About one or two tons of thorium compound should be sufficient for this purpose, and therefore a sufficient amount of space to accommodate this amount of material will be needed. It does not seem advisable at this time to try to devise arrangements for placing the thorium within the pile; the placement of the thorium near the edge of the pile should be sufficient to meet the requirements of these experiments.

"(2) Readily accessible space should be left near the pile so that small samples, say up to about ten pounds, can be irradiated with neutrons. There are a number of experiments that can be best done with these neutrons because of their high intensity, because there

will be no very fast neutrons mixed with them and because they will have exactly the energy distribution in which we are interested. One such experiment is the important one of the determination of whether or not U^{239} undergoes fission with slow neutrons. This experiment is so difficult that a neutron source of this type may be the only one with which the experiment can be performed. This neutron source might be used both for the production of the U^{239} and for the test of its fissionability with slow neutrons. For an experiment such as this, it might be desirable to have an arrangement so that the material might be introduced into the interior of the pile. Another experiment which might be done with these neutrons is the redetermination of the relative yield of the fission products. Having worked out the procedures for this in experiments using cyclotron neutrons, it should be relatively easy to do this. The relative fission product yields from the neutrons in the pile might differ somewhat from the relative yields by cyclotron neutrons. For this experiment there would seem to be no great advantage gained by placing the material within the pile except that the neutron energy distributions will vary with the position somewhat.

"(3) For another type of experiment, namely, the test of our chemical extraction procedures on the metal in the pile, it would be worthwhile to have some of the material in a position so that it could be readily removed before the cessation of the operation of the pile. This, of course, would also make it possible to keep a check on the yield of 94."

Fermi expressed his view that a hole might complicate the pile structure; and it was agreed that general experiments could be done just outside the pile, using a suitable geometry and a graphite reflector. Moore questioned having a port or sample hole in Pile III, but Fermi thought there would be more use of this than in Pile II because of the greater specific intensity.

Allison pressed to have Spedding returned as a member of the Technical Council. Compton said he didn't want to return to the composition of the previous Planning Board but finally agreed. Compton went on to report on the relationship of the pile project to others, saying that Conant's Executive Committee has studied

the progress of the centrifuge and diffusion plants and found them slower than ours. Also, more "heat" is to be put on us.

Wheeler brought up the subject of temperature experiments and their necessity in designing a helium-cooled pile that will run at high temperature. He said that experiments at Argonne Forest with Pile I will give temperature dependence in a range where the so-called "thermal" neutrons do not have the same correspondence to the temperature of the pile as they would have in a plant operating at higher temperature. Fermi agreed that the temperature dependence measured in Pile I may be misleading; there would be difficulties, however, in performing an intermediate (exponential) experiment. Fermi estimated that the work involved in building a high-temperature pile would delay us two months. Compton spoke up and "Let nothing further stand in the way of Pile I. We are already limited by materials, space, equipment and personnel." He continued, saying that he was thinking of using Jesse and Mitchell in connection with neutron temperature experiments and Fermi replied that he preferred rather younger physicists, just before or shortly after getting the Ph.D.'s.

There was more discussion of arranging to use the University of Michigan cyclotron at Ann Arbor to carry on fast neutron work. Compton said Franck has been cleared so that he could go to take charge of the Ann Arbor program, but perhaps it would make more sense for him to take on some responsibility at the Met Lab; the possibility of his taking responsibility for Burton and Coryell was discussed. Compton said that he is making plans to have Charles Cooper become overall supervisor of the Met Lab chemistry program starting next month. The remainder of the meeting was concerned with a further discussion of manpower needs and such topics as helium purification and procurement problems.

On two fronts the Allied news is good today—the Allied drive gains in Egypt and a Japanese tank attack was beaten on Guadalcanal. In Stalingrad, however, the Nazis won two streets.

Tuesday, October 27, 1942

Bertrand Goldschmidt sent a telegram from New York City addressed to "Seaborg's Team." The message read as follows: "LONELY FAR FROM YOU I REALIZE HOW HAPPY YOU MADE ME FEEL IN CHICAGO AND MISS YOU ALL HOPE BILL IS OK THE BAG IS A BEAUTY AND SO USEFUL THANKS AGAIN SAD NOT TO BE WITH YOU TONIGHT BEST OF LUCK." The reference to Bill concerns Bill Knox who injured his kidney rather severely in a touch football game played on a field in the Midway a few weeks ago. Fortunately he is recovering nicely. The expressed regret that Bert will not be with us tonight refers to our regular Tuesday evening meeting of my group's Research Associates which he attended during his stay with us.

At the meeting this evening I read Bert Goldschmidt's telegram which the fellows appreciated very much; it is clear that he won a place in the hearts of all members of my group during his relatively short stay with us—his scientific contributions were outstanding.

News from the Pacific is grim today. The Navy revealed that two of our larger ships—the aircraft carrier "Wasp" and a destroyer—were sunk and another carrier was damaged.

Wednesday, October 28, 1942

Cunningham and Werner finished their determination of the solubilities of plutonium phosphate and iodate in various solutions with the following results in terms of mg plutonium per liter: for the phosphate in water, 10 mg per liter, in 1 M HNO_3 , 25 mg per liter; in 1 M NaH_2PO_4 , 20 mg per liter; for the iodate in water, 0.45 mg per liter; in 6 M HNO_3 , 6.2 mg per liter; in 1 M HIO_3 , 24 mg per liter; in 5 M HIO_3 , 84 mg per liter; in 1 M H_2SO_4 , 73 mg per liter; in 5 M H_2SO_4 , 103 mg per liter; in 1 M $(\text{NH}_4)_2\text{SO}_4$, 34 mg per liter. The solubility data offer evidence for the formation of complexes of plutonous plutonium (Pu^{+4}) with oxalate, iodate and sulfate and possibly with carbonate and phosphate, although the latter two must be comparatively weak.

10/28/42

Perlman and Knox are still investigating the version of the "Wet Fluoride Method" in which the first lanthanum fluoride precipitate is made from a 10% UNH solution with 0.5 M HNO_3 in which the 94 is oxidized and thus remains in solution, and then after reduction the 94 is co-precipitated with the second lanthanum fluoride precipitate. They have used neutron-irradiated UNH which has cooled only about five days (rather than three months as before). Upon going through this procedure, it appears that a much higher percentage of the fission product gamma activity is present with the 94 in the second precipitate--amounts of the order of 10-25%--depending on the time of counting after precipitation (the higher percentages coming from the later times of gamma counting). Since the main gamma activity seems to be due to the $\text{Ba}^{140} \rightarrow \text{La}^{140}$ decay sequence, they then added barium carrier and precipitated barium sulfate with the first lanthanum fluoride precipitate. This reduced the amount of fission product gamma activity with the 94 in the second lanthanum precipitates to 3-5% of that originally present.

Perlman, Covey and I went over to West Stands to select some pieces of uranium metal, as we wish to include uranium metal with the next batch of UNH we will irradiate with neutrons at the Washington University cyclotron. I delegated Covey to see that the metal is cut and wrapped to our specifications; also to put the recrystallized UNH in boxes and load it all onto a truck with suitable amounts of graphite (for slowing the neutrons) and Masonite (to be used to contain the material) so that it can be hauled down to St. Louis. Covey will supervise the bombardment preparations and has already arranged for his train reservation to St. Louis for November 3.

Americans have beaten back an enemy thrust on Guadalcanal and sank two and hit six warships.

Thursday, October 29, 1942

We are holding meetings of the Group Leaders et al. of the Chemistry Division on Thursday mornings in Room 209, Eckhart Hall. The attendees, besides myself, include Allison, Boyd, Brown, Burton, Coryell, Cunningham,

10/29/42

Perlman, Spedding, Teller, Voigt and Wheeler. The meeting this morning was devoted to the separation and properties of element 93; it started at 9:00 a.m. and ran for about an hour and a half, with reports by Coryell, Perlman, Voigt and me. After a short report by Coryell on the properties of 93^{239} beta and gamma radiation, Perlman and I summarized the chemical properties of 93. We described its two oxidation states and how the oxidation potential fits into the table of oxidation potentials. We summarized the insoluble compounds (fluoride, iodate and so forth) of the lower oxidation state and the carrying of oxidized 93 by sodium uranyl acetate. We also described the volatile compounds (such as the higher fluoride) of 93. Emphasis was placed on the efficient carrying of reduced 93 on lanthanum fluoride and non-carrying by thorium fluoride. Voigt described his experiments at Ames Laboratory on the oxidation of 93 by such oxidizing agents as peroxydisulfate ion plus silver ion and by chlorate ion.

Gofman wrote and returned the corrected U^{232} draft. I submitted it today for publication as a Laboratory CN report. He assured me that the amount of 94^{239} that I gave him early this month will be sufficient to complete their fast neutron measurements. He asked if I want an interim report on these measurements or if I will be satisfied to wait until they are completed. They hope to complete these, as well as measurements on the slow neutron cross section, within the next few days.

We received the samples of sebacic acid and phenylarsonic acid today from Gilman at Ames. I sent him a letter thanking him for his prompt assistance.

Mitchell in the Department of Physics at Indiana University sent a request for more sources of 93^{239} and Pa^{233} , 100-200 microcuries of the former to measure the energy of the high-energy (which he thinks is about 600 Kev) gamma emission and 5 microcuries to repeat a beta-beta coincidence measurement, and 10-20 microcuries of the latter to initiate some experiments. He described some of the results that his group has obtained already with the 93^{239} . In two separate experiments, one on beta-gamma coincidences and the other on beta-beta coincidences, they have estimated that roughly 20 percent of the electrons are internal

10/29/42

conversion electrons. I replied, saying, "The results which you described in your letter are certainly very interesting. However, I am inclined to think that your deduction that there are only altogether 20% as many conversion electrons as there are disintegration beta particles may be wrong. We have so much evidence that there are more conversion electrons than this. I presume that you are being very careful to be sure that you are counting quite low energy conversion electrons. Of course, we may be wrong, and we will watch your experiments with great interest."

I also wrote, "We can have ready for you for mailing by Saturday the 10-20 microcuries of Pa²³³ and 5 microcuries of 39, so that you should receive this by Monday. We shall have some heavily bombarded material coming up from St. Louis early next week, so that we may be able to mail you the 100-200 microcuries of 39 on about Thursday."

Friday, October 30, 1942

This morning I started to keep a notebook for patent purposes, of ideas that occur to me concerning the chemistry of 94. My first entry said, "It seems likely, in view of the similarity between the chemical properties of uranium and element 94 (plutonium), that some of the methods for the preparation of metallic uranium will also be suitable for the preparation of metallic 94 (plutonium). Thus the high temperature reduction of the oxides, carbides, chlorides, fluorides, etc., by highly active metals such as sodium, calcium, magnesium, aluminum, etc., should result in the production of metallic 94. Also the electrolysis of molten plutonium salts, such as the chloride or fluoride, mixed or not mixed with alkali or alkaline earth halides should result in the production of metallic plutonium."

To this I affixed the statement, "Disclosed to and understood by me, this date, October 30, 1942," and had it signed by Perlman and Thompson (Figure 22). This is standard procedure required by the Lab's patent office and is carried out for all laboratory notebook entries.

During the last few weeks Kohman has performed experiments using ${}_{94}^{238}$ as tracer to test the use of thorium peroxide as a carrier for

Oct. 30, 1942
G. J. S. 1**SECRET**

It seems likely, in view of the similarity between the chemical properties of uranium and element 94 (plutonium), that ~~some~~ of the methods for the preparation of metallic uranium will also be suitable for the preparation of metallic 94 (plutonium). Thus the high temperature reduction of the oxides, carbides, chlorides, fluorides, etc., by highly active metals such as sodium, calcium, magnesium, aluminum, etc., should result in the production of metallic 94. Also the electrolysis of molten plutonium salts, such as the chloride or fluoride, mixed or not mixed with alkali or alkaline earth halides should result in the production of metallic plutonium.

Glenn T. Seaborg
Oct. 30, 1942

Disclosed to and understood by me, this date,
Oct 30, 1942 —
Stadore Perlman
Stanley G. Thompson

change notes Oct 30, 1942
Stadore Perlman
Stanley G. Thompson

Fig. 22 Notebook entry for patent disclosure, October 30, 1942.

XBB 761-7500

10/30/42

element 94—a method which Perlman and Knox have worked on earlier. The aim of this method is to separate element 94 from uranium and all fission product elements by a single precipitation with hydrogen peroxide using thorium as carrier. This method is distinguished from the uranium peroxide precipitation method by the fact that ammonium sulfate is used to hold uranium in solution. Kohman has found the optimum acidity for this process to be pH 3.0-3.5 and the minimum H_2O_2 concentration at which both thorium and 94 can be completely precipitated is approximately 0.6%. Indications in these tracer experiments are that 94 peroxide is more insoluble than thorium peroxide. The contamination of the precipitate by fission products is a serious problem, especially, since zirconium is found to form an insoluble peroxide under certain conditions.

Newspapers report that the U.S. has retaken lost positions on Guadalcanal.

Saturday, October 31, 1942

Joe Kennedy sent me a wire from Berkeley. He is leaving there next Tuesday for Chicago to confer with me on the chemistry of 94 and to attend to other business.

Our report, "Production and Properties of U^{232} " by Gofman and me, was issued today as Report CN-332. This covers work that has been done at Berkeley by Gofman during the last few months at my suggestion. He has found that the bombardment of thorium with the 16 Mev deuterons in the Berkeley 60-inch cyclotron produces, in addition to the 27.4-day Pa^{233} , the new isotope Pa^{232} . The Pa^{232} is produced by a $d,2n$ reaction and decays with a half-life of 1.6 days by the emission of beta particles and gamma rays. The Pa^{232} decays to the alpha-emitting daughter U^{232} whose half-life of 30 years is estimated by measuring its yield of alpha particles produced from the complete decay of a sample of Pa^{232} whose absolute beta intensity was determined with the use of a calibrated Lauritsen electroscope.

10/31/42

Today Covey loaded the 300 pounds of recrystallized Mallinckrodt UNH, uranium metal, graphite and Masonite construction material on a truck and sent it all on its way to St. Louis. This bombardment will be given the designation Chicago III.

Secretary of the Navy Frank Knox announced today that the Japanese have "retired from the scene" of the Solomons battle.

NOVEMBER 1942

Sunday, November 1, 1942

Headlines from the Solomon Islands say that the fourth U.S. carrier was lost reducing the U.S. carrier fleet to three. The carrier was sunk deliberately after it was damaged by Japanese air attacks.

Monday, November 2, 1942

To our delight, Miss Smith, whom Perlman and I interviewed a few weeks ago, has decided to accept our offer and is beginning her first day of work with us today as our secretary. She told us that a fellow working in Eckhart Hall whom she knew in school urged her to accept the position with us, indicating that she would find it to be a very worthwhile and interesting experience. Obviously she is intrigued with the strange new world she is entering, and it must be in this spirit of adventure that she has decided to cast her lot with us. Illness last week prevented her from starting to work earlier.

In my reply to Gofman's letter of October 27 today, I suggest that he complete his fast neutron measurements without sending me the preliminary results and that he can wait until then to go on with his slow neutron measurements. I asked him to tell Wahl and Prestwood that we are especially interested in their attempts to devise new methods for dissolving lanthanum fluoride, that this is a practical problem that must be solved as soon as possible. This is the first letter that I dictated to my new secretary, Miss Smith.

The British have seized a new sector on the Egyptian front. The U.S. afforded air support.

Tuesday, November 3, 1942

During the last few weeks I have been worried about an aspect of a nuclear weapon made of element 94 that might make it inoperable and have discussed this thoroughly with Perlman. Suppose we purify 94^{239} for a bomb, but there is a minute trace of boron or other light element in it. Won't the alpha particles emitted by the 94 in its radioactive decay react with such light elements to produce neutrons and thus trigger the bomb prematurely? If so, what about the great concern that Oppenheimer and the other theoreticians have about the possibility that 94^{239} has an unacceptable rate of spontaneous fission? The more I have pondered the matter the more I have become convinced of my conclusion. So I started making rough calculations. My calculations are inescapable: if I am right, then 49 for a working bomb would have to be purified from light elements beyond anyone's imagination. I have checked my concern with Teller and Manley, and they agree that the fate of the whole 49 project hangs in the balance.

By the time I reached my office this morning I already had composed a letter in my head to Oppenheimer which I dictated to Miss Smith (with a copy to Arthur Compton):

"Dear Robert:

"There is one point that has been worrying me quite a good deal since the discussion that we had in Berkeley the early part of last month. This relates to the number of neutrons that it is permissible to have present in the final 49 product in order not to cause complications in its control. You have stated that it would be ideal if the spontaneous fission rate were as long as 10^{19} years. If this figure is a desirable limit, and if you cannot get around it any other way, this creates a formidable chemical problem because of the possibility of forming neutrons from the α, n reaction on light element impurities. Since the alpha-emitting life of 49 is about 10^4 years, 10^{15} alphas must not produce an undesirable neutron. Assuming that an element like boron, for example, has a cross section for the α, n reaction of about 1 in 10^4 , this would mean that boron must be absent in the final product to the extent of 1 part in 10^{11} .

11/3/43

"You can see why I am disturbed if this calculation is correct and if you are actually limited by this requirement. Even if you can stand 10^5 times as many neutrons as this, making the limits of light impurities which are permissible one part in about a million, the final chemical purification is still a formidable problem. In fact, if these requirements are going to be placed upon our chemical procedures, I should like to know definitely about it as soon as possible since this will require a great deal of development work along lines which so far have never been attempted.

"I have discussed this matter somewhat with Dr. Manley and Dr. Teller and I believe that they also consider it a rather serious problem."

Our "Report for October 16-31, 1942. Chemistry of 94. University of California and University of Chicago Groups" (No. CN-328) was completed today. The Report states that Perlman and Brown have commenced studies on the problem of removing essentially all the fission product gamma activity from the final purified 94 so that it can be handled without elaborate shielding. Their measurements and calculations show that the amount of penetrating fission product gamma radiation associated with 4 kilograms of 94 in a 10^5 kw pile operated for 40 days would be equivalent to six tons of radium 6 days after removal from the pile, and to one ton of radium 40 days after removal from the pile. This would indicate there is little point in delaying extraction of 94 beyond one week after shutdown.

The Report continues, saying that Cunningham and Werner, using ultramicro (about 0.1 microgram) amounts of plutonium, have made solubility determinations for the following compounds in various solutions--iodate, hydroxide, peroxide, phosphate, oxalate and carbonate--and the numerical values are listed. It says that Brown, Hill and Jaffey have gone on to a study of other possible volatility methods since the fluorination method has been turned over to the chemical engineers for investigation. Experimental work has been done on the possibility of a combination process which would use chlorine to remove the uranium (as the pentachloride) followed by volatilization of 94 with fluorine. Initial chlorination tests show a possible problem in that nonvolatile chlorides of fission products and UX_1 are swept over with the volatile uranium, thus raising

11/3/43

the possibility that the nonvolatile chloride of 94 might behave similarly.

It is reported that Thompson has studied the organic reagents oxine, dithizone and meta nitrobenzoic acid as possible means for purifying 94 after it has been removed from the bulk of the uranium and fission products. The meta nitrobenzoic acid shows promise as a means of separating 94 from 93 and also for separating 94 from the rare earths and UO_2^{+2} . He also has studied the behavior of 94 in concentrated phosphate solution. Tracer experiments show that about 90 percent of the 94 is precipitated with La^{+3} as the carrier in a concentrated NaH_2PO_4 solution in which $Zr_3(PO_4)_4$ is soluble, thus indicating that the use of phosphate solutions offers a possible means of aiding in the separation of 94 from fission products.

Our part of the Report concludes with summaries of the investigations of Magel and Cefola and of Perlman. Magel and Cefola have studied methods of producing metallic plutonium; preparation of cerium-sodium amalgam in the presence of tracer 94 showed that only 20 percent of the 94 was contained in the amalgam; an electrolysis experiment with pure plutonium sulfate and a mercury electrode demonstrated the production of plutonium amalgam but the yield was not complete. Hydrogen reduction experiments on pure plutonium oxide have also been carried out, but the nature of the black product formed has not been determined. Perlman has conducted studies to determine the amount of fission activity that would appear with crude 94 when first removed from the bulk of the uranium and fission activity in the Wet Fluoride Method for extracting 94. His results indicate that the gamma activity accompanying the 94 would amount to about 0.5 percent of the total activity.

In the Berkeley part of the Report Duffield reports on "Precipitation Reactions of 94 and 93," Gofman on "Oxidation and Reduction of 94 in Alkaline Solution," Garner on "Volatility of 94 and 93 Compounds," and Sheline and Prestwood on "Wet Fluoride Method."

Thompson has investigated the carrying of $94^{(r)}$ and $93^{(r)}$ with thorium upon precipitation with sebacic acid and finds conditions under which about 75 percent of the 94 is carried while only 25 percent of the 93 is carried.

11/3/42

Today he tested the precipitation of $94^{(r)}$ and $93^{(r)}$ with Zr^{+4} as carrier. Upon the addition of phenylarsonic acid, he finds under some conditions (1.7 N HCl) the carrying of 95 percent of the 94 with only 30 percent of the 93, indicating that this is the most effective organic reagent found to date for this separation.

I called Covey into the office, and Perlman and I gave him some last-minute instructions on setting up the uranium samples for bombardment at St. Louis before he leaves for there tonight. We are asking for 100,000 microampere-hours of bombardment, or possibly more.

Compton received a telegram from Kennedy, which he relayed to me. It said that Kennedy is leaving from Berkeley today, accompanied by Wahl, and they will arrive in Chicago Friday morning.

Goldschmidt sent me a cordial, four-page handwritten letter from the Chateau Laurier hotel in Ottawa, apologizing for not writing sooner, saying that he was paralyzed by the idea of writing in English and that any resemblance between his spelling and the English language would be purely coincidental. He should have put his fears to rest, however, because he wrote and spelled as well as most educated Americans. He mentioned how sad he was at leaving Chicago, knowing that everything would be continuing at full speed, which he could not follow any more, adding, "I felt quite at home, everybody being nicer than I would have ever dreamed of, the maximum having been reached with the farewell party and lovely present you all gave me."

He wrote that after returning to New York for a few days and visiting family and friends, he left for Montreal last Wednesday evening, anxious to see what the town looked like because there is a big probability that he will live there for a long time. At the time that Goldschmidt left Chicago, hardly more than a week ago, the Canadian National Research Council had not decided where to establish the Anglo-Canadian research laboratory. Evidently from his letter, the decision is to settle in Montreal. He described Montreal as rather pleasant, like a small U.S.A. town, with a few main streets with streetcars, nice shops, posters written in English and French, and good-looking people. He expects to return there from Ottawa in a few days, "to start everything except scientific

11/3/42

work, probably looking for flats for the team members and other odd jobs of the same type."

His letter was scattered with many personal observations and questions. He said that he is grateful for all the technical knowledge he learned in Jones 401. He asked me to tell all the fellows in my group that he misses their companionship deeply. He ended his letter by saying, "Tell the new secretary that I am longing to meet her, and advise her to be careful with Magel and all the other hunting wolves around!" I am so sorry that Goldschmidt is not here to grace us with his presence any longer.

The Metallurgical Laboratory issued a patent report by Greek Wells and Foster York, covering the period between September 1 and October 31, 1942, showing seven applications completed or prepared, of which six originated with me and my co-inventors. They are:

"Masses and Compositions of Radioactive Elements and Preparation Thereof" (an omnibus case disclosing basic ideas on 94, including broad claims such as macroscopic masses of 94, compounds of 94 and methods of separating 94 from fission products and uranium). Seaborg and Wahl (Case S-1-52-P).

"Methods for Separating Foreign Products from Radioactive Elements" (extraction of element 94 with ether or other organic liquids). Seaborg and Wahl (Case S-1-53-P).

"Peroxide Process for Separation of Radioactive Materials." Seaborg and Perlman (Case S-1-57-P).

"Masses and Compositions of Radioactive Isotope" (an omnibus case of U^{233} , including broad claims such as macroscopic masses of U^{233} , its compounds, method production and separation). Seaborg and Gofman (Case S-1-57-P).

"Fluorine Process for Separation of Materials" (dry fluoride process for 94). Seaborg and Brown (Case S-1-58-P).

"Adsorption Process for Separation of Materials" (specifically, the adsorption of 94 by diatomaceous earth). Seaborg and Willard (Case S-1-59-P).

The seventh application on "Lattice System" (Case S-1-51-P), naming Leo Szilard as the inventor, is in the process of preparation and relates to the uranium-graphite lattice system for producing a chain reaction.

11/3/42

Szilard's claim goes back as early as July 8, 1939, when he wrote to Fermi from New York City suggesting that an experiment be performed using about 50 tons of carbon and 5 tons of uranium in the form of oxide, not mixed but built up into alternating layers, as a first experiment. It is interesting to note that Pile I at the Argonne Forest, the hoped-for first chain-reacting pile, will require 6 tons of uranium metal, 60 tons of uranium oxide and over 500 tons of graphite, which is scaled up considerably from Szilard's original conception, but will have about the same proportion of uranium to carbon.

At the meeting of my group's Research Associates this evening was much talk about my concern over the extreme purification of 94 that will be required to prevent the generation of neutrons by the reaction of alpha particles with light element impurities. Brown and Perlman are going to make some more quantitative calculations on the limits of concentration of light element impurities that can be tolerated in a nuclear explosive device.

Allied ground forces have recaptured Kokoda, chief inland base of the Japanese in New Guinea.

Wednesday, November 4, 1942

I received a letter from Hamilton in Berkeley thanking me for the Goldschmidt-Perlman report on fission products, which, he says, will be helpful in determining which fission products he should emphasize in his ingestion experiments. He said he has now built up a fairly complete establishment with all the necessary equipment but lacks a few items which he hopes I can help him supply, mentioning hafnium-free zirconium, columbium metal and ruthenium. He informed me that our thorium target will receive its full 5,000 microampere-hours of deuterons by the middle of next week and will be shipped to me when the radiation level becomes low enough; he asked for some of the produced U^{232} for tracer purposes. "There have been some changes around here," he said, "and one of them has been that I am supposed to be responsible for the 60-inch cyclotron, its

11/4/42

bombardment, the bills, etc., and so you may be sure that you will get everything I can possibly prepare for you. However, I should like very much to know what you would like to have prepared during the next few months so that I can plan on the disposition of cyclotron time for you and the various projects here in Berkeley to try to give everybody what they need." He asked whether he should come to Chicago at the end of the month to discuss his proposed program of biological work on fission products with Perlman and me. He closed by asking that I tell Helen that he is looking forward to more scrambled eggs the next time he comes to Chicago.

Wahl wrote a letter too, saying that he will not include his report on the separation of the 200 micrograms of plutonium from UNH in our semi-monthly report. He said that Latimer feels that it should be a separate report because of its length and that it should be available to engineers who might be considering the Wet Fluoride Method.

An eight-man investigative committee, appointed by the du Pont Company Executive Committee, has arrived here at the Met Lab for a three-day visit. They are reviewing the status and plans of the Project in order to decide whether or not du Pont will take on the job of design and construction of the plutonium production and separation facilities as requested by General Groves. The committee members are E. K. Bolton, T. H. Chilton, T. C. Gary, C. H. Greenewalt, C. R. Johnson, F. W. Pardee, Jr., C. M. A. Stine, and Roger Williams.

Reports of Allied gains in Egypt were pushed far back in the paper today as the front pages were filled with election results. The Republicans made gains in both Houses of Congress.

Thursday, November 5, 1942

Today, Cunningham and Werner, continuing to work on the ultramicro-scale, determined the solubility of a number of compounds of plutonium. Because of the growing interest in the co-precipitation of plutonium with zirconium phosphate as a potential separation process, they made more

11/5/42

measurements on the solubility of plutonous phosphate. They find a solubility of 29 mg plutonium per liter in 5 M NaH_2PO_4 . Since this value is only about 1.5 times that for the solubility of plutonous phosphate in 1 M NaH_2PO_4 and only about three times that for its solubility in water, determined last Wednesday, there is no evidence for the formation of a strong phosphate complex. The solubility of plutonium peroxide in acid solution is also of interest in connection with the peroxide method of separating plutonium from uranium and fission products. Cunningham and Werner treated a solution containing about 0.1 λ plutonium in 1/2 λ of 6 M HNO_3 with an equal volume of 30% H_2O_2 . A precipitate formed at once. A sample of the supernatant liquid was withdrawn for alpha counting. Activity corresponding to 28 mg plutonium per liter was found, which is to be compared with the solubility of the peroxide in water—16 mg plutonium per liter. The insolubility of plutonium peroxide in acid solution may make possible a purification procedure based upon the precipitation and reprecipitation of the peroxide from acid solution.

Kirk wrote to Cunningham that he is putting all his efforts into putting finishing touches to the new ultra microbalance, making tests as to its reproducibility and durability, etc., so the microchemists can start using it without delay. He offered to bring it to Chicago personally. Cunningham, Cefola and I talked the matter over and we decided it would be best for Kirk to wait until next month when it can be installed in our new chemistry building. Heavy slabs will have to be brought in on which to mount the ultra microbalance, and it would be a waste of time and effort to get set up in Jones Laboratory, especially since I expect there will be something of a turmoil preparing to pack and move within the next few weeks. So I wrote a letter to Kirk explaining the situation, saying that this will give him a further reprieve in time, and that we estimate he should visit us around the first of December. I also enlisted his help in designing a special high-speed centrifuge capable of having the precipitate removed by remote control and in which the centrifuge bowl can be used as a reaction vessel. I enclosed a rough diagram and specifications of what we want. We hope that he will be able to come up with an improved design that will permit the easy removal of precipitates.

11/5/42

Wahl is issuing his report "Separation of 0.2 mg Plutonium from 45 kg of Uranium and 0.25 curies of Fission Products," which describes in detail his chemical procedure for isolating the 94^{239} from the 210 pounds of UNH which was bombarded with neutrons at the Berkeley cyclotron from April 24 to June 20. Wahl began his separation after the sample had cooled about a month, starting with an ether extraction, and then carried out a number of oxidation-reduction cycles using rare earth fluoride as carrier and measuring the yield of 94^{239} through each step. Last month, on September 29, he finally isolated the 0.2 mg of pure 94^{239} , with an overall yield of 92%, in the form of the hydroxide. The actual weight of the 94^{239} , as determined by alpha particle counting, is 195 micrograms, calculated on the basis 2×10^4 years for half-life of 94^{239} .

The Technical Council met, attended by Allison, Fermi, Speer, Wheeler, and Wigner. They decided to meet on a regular basis every Thursday. The main subjects of discussion were the purity of helium available from Amarillo, Texas, the production of uranium and the need for more knowledge of the metallurgical properties of uranium. Allison reported that Edward C. Creutz has paid a visit to Battelle Memorial Institute and finds it well-equipped with trained people to undertake the study of semi-plant scale metallurgical problems.

Fermi was pessimistic about conducting pile experiments at the Argonne Forest laboratory. The building originally planned for completion on October 12 was postponed until October 20, and now it appears that it will not be ready until the end of December, all because of union trouble. He believes that it is best to do the experiment demonstrating the nuclear chain reaction in the West Stands as originally planned, even though flashing of the pile could not be done there. Later, after critical dimensions for the pile have been determined, the pile could be moved to Argonne Forest. A decision on this should be made by Monday.

Allison said that Burton, Franck and Mulliken think that both the Ann Arbor cyclotron and the Notre Dame Van de Graaff accelerator should be used but the central office for this effort should remain in Chicago.

11/5/42

The Allies are chasing the Axis troops in Africa. Reports from Greece say Germany is rushing troops from the Russian front to aid Rommel in Africa.

Friday, November 6, 1942

Covey returned from St. Louis by train early this morning. He told me that he has built a special table at the cyclotron to hold our 300 pounds of UNH and our uranium metal and has set these up in proper form for our neutron irradiation, Chicago III. Our second neutron-irradiated UNH from St. Louis (Chicago II) has been delivered to the North Stands on campus where the first ether extraction cycle will be carried out under the direction of Perlman and Jaffey. Because an adequate working area, readily accessible, is available here, we believe this is a better place than the attic and roof area on the fourth floor of Jones Laboratory for carrying on this operation. The product solution, after a second ether extraction, of a few liters volume will then be turned over to Cunningham and Werner for final isolation of the pure 94^{239} .

Thompson is starting today to investigate the carrying of $94^{(r)}$ by the precipitation of phosphates that are insoluble in acid solution. He is beginning by investigating the use of bismuth phosphate and zirconium phosphate. Cunningham and Werner have found plutonium phosphate to be quite insoluble in H_2O (10 mg plutonium per liter), 1 M NaH_2PO_4 (20 mg plutonium per liter), 5 M NaH_2PO_4 (29 mg plutonium per liter), and 1 M HNO_3 (25 mg plutonium per liter). Furthermore, Cefola has found that $94^{(r)}$ is co-precipitated with zirconium phosphate. All in all, this information makes a method based on phosphate precipitation very attractive because the Wet Fluoride Process has corrosive qualities and yields precipitates with poor filtration qualities from the standpoint of the engineering scale of work; thus an alternative precipitation method should be developed to provide a choice.

Today Thompson investigated, using 94^{238} tracer, the carrying of 94 by bismuth phosphate using 0.3 mg Bi^{+3} in 10 cc of solution. The carrying of 94 was only about 22% and the fear is that this might be due to the

11/6/42

fact that plutonous phosphate is not isomorphous with bismuth phosphate. Thompson then performed an experiment in which he precipitated zirconium phosphate using 0.3 mg Zr^{+3} and a small amount of phosphoric acid in order to avoid the redissolving of zirconium phosphate that occurs in high phosphate ion concentration. He finds that 54% of the 94 is carried. In another experiment using bismuth phosphate as carrier he finds that 72% of the 94 is carried. In view of the variation of the results with bismuth phosphate, he has decided to try first to work out the conditions for carrying of 94 by zirconium phosphate.

Today Brown and Hill performed an interesting experiment. The aim was to see whether or not UF_6 when evaporated from its solid or liquid state can be freed from tracer amounts of nonvolatile activity. A tank of UF_6 , which is quite old (about seven months) so that it contains an equilibrium amount of UX_1 (thorium), was opened; and the UF_6 that distilled out was dissolved in water. This was evaporated to dryness and then weighed and counted. It was found that the UF_6 distilled was 100 times less beta active (i.e., UX_1 activity) than the UF_6 present in the tank. In view of the fact that the distillation method used was so simple, it would appear that direct fractional distillation of neutron-bombarded UF_6 would be a rapid way of separating element 94 and fission products from uranium. It would also appear that UF_6 might be a feasible material for use in a continuously operating pile, in which liquid UF_6 could be circulated, and then evaporated from the fission products and 94 in an evaporator on the outside. Such a scheme might well offer definite advantages.

Kennedy and Wahl arrived in Chicago today as expected. Kennedy was especially interested in discussing with me the problem of purifying the final 94 product from light elements. This is Wahl's first visit to our Jones Laboratory area, and I took pleasure in showing him our laboratory facilities; we discussed the status of 94 extraction work, the purification problem, etc.

The eight men of the du Pont investigative committee concluded their visit today. Wednesday was spent in detailed and exhaustive discussion with many people here at the Met Lab. The committee met with Compton and

11/6/42

Hilberry yesterday and today. Chilton, Pardee and Johnson will remain until tomorrow to discuss pile design mechanical problems. The following comments were made to Compton by the du Pont delegation and in general accepted by him:

1. The production of uranium metal should be greatly expanded (by a factor of 5-10) until the ore supply becomes a bottleneck.
2. An intensive study of uranium fabrication into shapes of various sorts likely to be used in pile construction should be made.
3. Design and construction of D_2O plants should be undertaken immediately (probably four 2-ton plants will be needed).
4. Physicists working with engineers should begin design of a D_2O pile.
5. In the present pile program (which should not be abated, but increased if possible) engineering emphasis should be increased and physicists should limit themselves to their own sphere of action.
6. The following critical points were noted in any pile design:
 - a. Control should be more positive.
 - b. More thought and experimental attention should be paid to thermal stability.
 - c. More intensive activity on coatings for uranium should be undertaken.
 - d. Mechanisms for positive charging and discharging, particularly for Pile III, should be developed.
7. Emphasize Wet Fluoride Process for separation of 94^{239} and develop a method for removing the residual fission products from spent uranium liquors so that these will be safe for ordinary storage.
8. Continue work on the Dry Fluoride Process—consider abandoning other wet methods.

The headline today says "'Complete Victory' in Egypt!"

Saturday, November 7, 1942

Pushing war front news into second position is news of strikes in war plants in Detroit.

Sunday, November 8, 1942

Big headline in the Sun today: "AEF Opens 2d Front." U.S. troops have invaded French North Africa; they were backed by the British Navy and the RAF, with British troops to follow later. President Roosevelt was on the radio speaking in French, asking "Frenchmen everywhere not to obstruct the action."

Monday, November 9, 1942

All last week I was in suspense wondering what Oppenheimer's response to my letter would be. Today I received his reply. He also sent copies to Manley, Teller and Compton. Because of its significance, I will quote in full:

"Dear Glenn:

"Thanks for your fine letter. The problem you raise is not a new one, nor is it limited to the 49. I've thought about it a little in connection with the 25-24, and it is probably time to get possibilities clear.

"With the 25 alone matters would not be so bad: a concentration of light impurities (B, Be, Al, C, N) of 10^{-4} would give us the more than ideal 10^{19} years equivalent. If, as in our present set up, almost all the 24 goes along with the 25, then things are about 25 times worse. I believe that we can probably get along with 10^{17} years equivalent if we have to. Therefore I should say that the chemical problem with the 24-25 mixture was hard but probably soluble. Do you agree in this?

"With the 49, even allowing a factor 10 in your estimate of yield and a factor 100 in our requirements, it still comes to a purity of about 10^{-8} . Is this hopeless?

"It would be a help to know what you think on these points fairly soon, since if your answers are in the negative it will mean not only rather radical and I am afraid rather inefficient redesign, but also the immediate prospect of some new production problems for other materials.

11/9/42

"How bad is 23?"

"Thanks again for your letter, and let me know what your ideas re this chemistry are as soon as you can.

"With all good greetings,"

It is clear that we have a very serious problem in the purification of 49 and that this is going to receive intensive top-level attention in the days immediately ahead.

I replied to Hamilton's letter that I received on Wednesday, telling him that I am airmailing him some of the chemicals that he has asked for, but that so far I have been unable to locate hafnium-free zirconium. After bringing up the matter of who should finance the Berkeley bombardments, I notified him that we will soon need another very heavy deuteron bombardment of uranium metal, the order of 20,000 microampere-hours, and that I am trying hard to have prepared a good target for that purpose. I indicated that it might be worthwhile for him to come to Chicago to confer about his biological work on fission products.

The French surrendered Algiers to the Allies today.

Tuesday, November 10, 1942

Whitaker has now returned from Site X in the Tennessee Valley, where he went on an inspection tour last Thursday, in the company of Major Warren George and Major Robert C. Blair of the U.S. Army, Harcourt C. Vernon, who is a du Pont man representing the Columbia University group, and T. C. Williams, Frederick R. Conklin and August C. Klein of Stone and Webster Company. After studying the plant layout prints in the Stone and Webster office in Knoxville, they all went out to the location and walked over the actual sites that have been staked out by the Stone and Webster people. They located the town site and the following developments in the upper area of the reservation: Administration Building, Cafeteria, Main Laboratory Building, buildings in the Columbia University development and buildings in the Chicago Area A development.

11/10/42

The prints showing the relative locations of these buildings were available at Site X at the time, but, as yet, copies have not been received here at the Met Lab. The Chicago Area A development is shown to be approximately half a mile from the Administration Building, and the Main Laboratory Building is parallel to the Administration Building and 200 to 300 feet back of it. Whitaker and his companions travelled by existing roads from Area A to Chicago Area B and measured the distance as 12.7 miles. Stone and Webster have made no detailed studies of Area B where the pile and presumably the chemical separation plant will be built. It is situated in a valley just below Bethel Church and in the widest expanse of relatively level ground which they saw in the entire area. This valley is approximately 1,200 feet at its widest point, and is a mile or more in length.

Stone and Webster has requested a detailed estimate of the personnel to be assigned to Site X with respect to number of men in a given salary range, number of single and married persons, numbers of families having one, two and three children, etc. Housing will be provided for those who know something about the work to be done at Site X, whereas laborers and others will live outside the village in housing already available.

At the meeting of my group's Research Associates tonight, in addition to the usual review of our research program and plans for the future, we discussed the progress being made in preparing for work at Site X. We are all very interested in what our role will be at the new installation there.

Today U.S. troops are closing in on the Moroccan city of Casablanca.

Wednesday, November 11, 1942

Compton and Hilberry paid me a visit in my Jones Laboratory office today to discuss the 49 purification problem whose severity has been brought to their attention on the basis of my correspondence with Oppenheimer. They are very worried about this new turn of events and expect that this new information will have an adverse impact on Conant and

11/11/42

the Review Committee that is considering the future of our entire Project. I confirmed that the problem is very serious and said its solution will be very difficult but not impossible if we attack it with a sufficient number of capable chemists.

Cefola and Magel have continued their electrolysis experiments to investigate whether the 94 can be reduced to the metal at a mercury cathode. They are now working on the ultra-microscale using high concentrations of 94 and find that they can deposit of the order of 20-30% of the 94 in the mercury cathode from 94 sulfate solution over times of about six hours.

News today tells about the U.S. forces in Algeria and their drive on Libya; they hold 500 miles along the Mediterranean.

Thursday, November 12, 1942

At the meeting of the Chemistry Division Group Leaders this morning I made a comprehensive report on the chemistry of 94. I described the radiation of 94^{238} and 94^{239} and how these isotopes have been used to determine the chemical properties. I described the "cold bromate method for separating 93 and 94 and summarized the insoluble compounds of reduced 94 ($\text{Pu}^{(r)}$) and the solubility properties of compounds of $\text{Pu}^{(r)}$ based on the work of Cunningham and Werner. I reported on the experiment by Cunningham and Werner, proving the +4 oxidation state through the use of $\text{Pu}(\text{IO}_3)_4$. I also described the volatility properties of the fluoride of $\text{Pu}^{(o)}$ and the volatility properties of Pu chlorides. Perlman described the methods for separating 93 and 94 in more detail and also the application of its volatility properties to a method of separation of 94, and reported on progress on the peroxide method of separation of 94. Johns described work at the Ames Laboratory on the oxidation of 93 and 94 and on the distillation of these elements from uranium metal. Burton summarized past and proposed work on the effect of radiation on materials used in separations processes.

11/12/42

Hamilton sent a telegram from Berkeley that our deuteron bombardment of thorium has been completed and the sample will be ready to ship in the next few days at our convenience.

Captain Arthur V. Peterson, who is the Army's area engineer at the Metallurgical Laboratory, recently asked me to submit some figures on the amount of fission-product radioactivity that might be available from a chain-reacting pile for military purposes. Today I sent him a three-page memorandum, which includes two tables that we were able to compile. Table I shows the total gamma activity in megacuries from a 10^5 kw pile as a function of operating time and time after shutdown (in intervals of five days up to 50 days). Table II gives the corresponding information for beta activity.

The tables show that the maximum gamma and beta activities (50 days of operation, 2-1/2 days after shutdown) would be 34 megacuries and 190 megacuries, respectively. We state that in terms of war-use possibilities, the medical group should be consulted, but in our opinion, (a) one megacurie of gamma activity when spread uniformly over two square miles will contaminate it to such an extent as to produce 100 r in a day throughout the area--as we understand it, we say, 100 r in a day is a disabling dosage, if not a lethal dosage; (b) for calculation purposes, the beta radiation can be considered to have 1.0 Mev upper limit, or 1/3 Mev average energy, and that to be effective as a possible weapon the radioactive material would have to be ingested. We state that all the activities listed in the two tables are derived from small-experiments with cyclotron neutrons, and the assumption is made (within a factor of two) that the ratio of fission activity to 94^{239} is the same with such neutrons as with the neutrons of an operating pile.

The U.S. troops are racing for Tunisia. I listened to Churchill speak on how the British routed Rommel in Egypt.

Friday, November 13, 1942

Today I drew up a chart that I call "Status of Projected Program for obtaining Final Product." It looks like this:

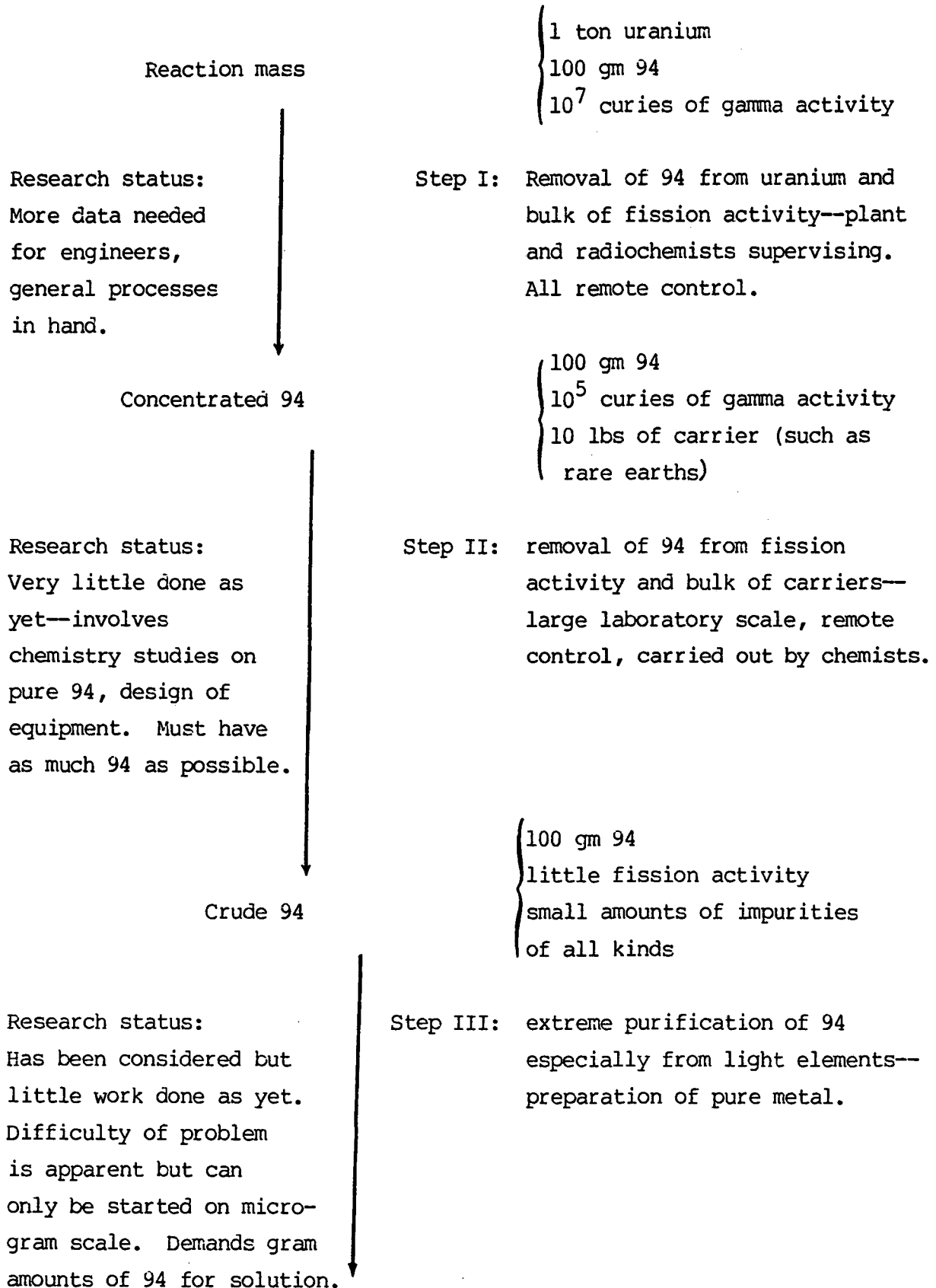

Saturday, November 14, 1942

At the meeting of the Technical Council on Thursday of last week Fermi made a proposal. According to Fermi's schedule, he had planned to complete the construction of Pile I, the first experimental chain-reacting pile, at Argonne Forest by December 15 and test it on January 1. But because of labor problems, the pile building will not be ready for occupancy until the latter date. So now Fermi asked Compton to agree to let him erect the first pile at the squash court under the West Stands where he has been conducting the exponential pile experiments. He convinced Compton that such a pile would be under control at all times because of the "delayed" neutrons in a chain reaction. It was a dreadful decision that faced Compton. If the chain-reaction could not be bound, the whole campus might be destroyed by the explosion, or at the very least, radioactive fission products would be spread far and wide. Compton has decided to go ahead!

In my notebook today I wrote: "I believe that in a uranium chain reacting structure there may be found other useful isotopes in addition to ${}_{94}^{239}$. The ${}_{94}^{239}$ may absorb a sufficient number of neutrons to form an appreciable amount of ${}_{94}^{240}$ and this isotope or one of its possible decay products (for example, ${}_{95}^{240}$) might be particularly useful in atomic power applications. Likewise the ${}_{92}^{235}$ might absorb an appreciable number of neutrons to form ${}_{92}^{236}$ and this isotope or one of its possible decay products (for example, ${}_{93}^{236}$) might be particularly useful in atomic power applications. We intend to look for such possible isotopes during the chemical extraction work on the 'uranium- ${}_{94}^{239}$ ${}_{93}^{239}$ -fission product' mixture from a chain reacting structure.

"It is also worth pointing out that when ${}_{94}^{239}$ is available in large enough amounts we intend to bombard it with high energy deuterons (for example, 14 Mev deuterons) in order to produce, for example, ${}_{95}^{240}$ (and its decay products) by the d,n reaction and ${}_{95}^{239}$ (and its decay products) by the $d,2n$ reaction, because these isotopes will be very interesting from the standpoint of many physical and chemical investigations. Also we intend to bombard pure ${}_{94}^{239}$ with neutrons in order to investigate the products formed, and particularly those in the transuranium and uranium region."

Continuing his work on the co-precipitation of $94^{(r)}$ with zirconium phosphate in order to develop an alternate method for the separation of 94^{239} from uranium and fission products, Thompson has obtained some hopeful results. In his latest experiments performed today, he has carried out his separation process from 10% UNH solution in order to simulate plant operating conditions. To such a solution, which was 3 N in HNO_3 and contained 94^{238} tracer in the lower oxidation state and 1 mg Zr^{+4} carrier in 10 cc total volume, 0.1 cc 6 M phosphoric acid was added so as to precipitate zirconium phosphate. After warming and allowing the precipitate to coagulate for about one hour, it was removed by centrifugation. The zirconium phosphate precipitate was then mostly dissolved in concentrated nitric acid, and, after the addition of La^{+3} and HF, a precipitate of lanthanum fluoride precipitate was found to contain more than 90% of the 94 which was present originally. (In a separate experiment, using 93^{239} in order to determine the behavior of 93 in this procedure, and which was identical in every way except that no uranyl nitrate was present in the original solution, it was found that only about 3% of the 93 was present in the final lanthanum fluoride precipitate.) An alternate procedure for the dissolving of the zirconium phosphate would be to dissolve it in HF, and this would be followed by the addition of La^{+3} so as to remove the 94 with a "preformed" lanthanum fluoride precipitate.

It seems worthwhile to test the volatility of 94 hexafluoride using pure 94 now that this is available. Today Brown and Hill performed such an experiment. They used 0.2 microgram of 94 oxide on a copper disc furnished by Cunningham. After "weighing" the sample by counting its alpha particles, the disc was treated with anhydrous HF at 500°C and again counted. By counting the alpha particles as well as by observation under the microscope, it was found that the small sample was still completely present, although changed somewhat in appearance. The substance was then fluorinated at 250°C for half an hour and counted again. About 5% of the material, as determined from the decrease in alpha count, apparently disappeared in this operation, but the material remaining looked unchanged when viewed under the microscope. A final fluorination was made at 500°C , and this time all of the 94, as determined from the decrease in alpha count, volatilized. Less than 0.02% (limits of observation) of the

original alpha counts remained behind. Likewise, all except a small fraction of the visible mass of materials, as determined by viewing under the microscope, remained after this final fluorination, which indicates that Cunningham's 94^{239} , while not 100% pure, had a rather high degree of purity. These experiments substantiate the conclusions that have been reached in the studies using 94 tracer, namely: (1) The lower fluoride (UF_4) is nonvolatile at 500°C . (2) The higher fluoride is probably formed to a very small extent at 250°C . (3) The higher fluoride is formed and volatilizes completely at 500°C .

In his experiments on the chloride volatility method of separating 94, Jaffey has found that UX_1 is swept over with the UCl_5 . He is now investigating the use of holdback carriers to prevent this. He added La_2O_3 to U_3O_8 containing 94 tracer and when he treated this with $\text{Cl}_2\text{-CCl}_4$ he found that most of the 94 activity remains back with the lanthanum indicating that with the appropriate use of holdback carriers, a chlorine process might indeed be feasible.

Magel is continuing to work on the development of methods for the preparation of metallic 94 and the study of its properties using a vacuum rack that he has constructed in the available area in the northwest corner of Room 404. During the last few weeks he has performed some experiments to attempt to test the volatility of 94 metal. To produce what he hopes will be a source of metal, he has bombarded clean metallic uranium with neutrons at the St. Louis cyclotron, has heated some of this 94^{239} -impregnated uranium in a high vacuum to a temperature of 1890°C , a temperature at which the melted uranium vaporizes at an appreciable rate. (For example, in one experiment about 70 mg of uranium were vaporized.) It was found in a number of such experiments that the 94^{239} concentrates in the vaporized fraction. It should be pointed out that there was present in these samples only about one part of 94^{239} per 10^8 parts of uranium so that these are only tracer experiments. However, since the 94^{239} does concentrate in the vapor fraction (which was condensed and analyzed), it seems fairly safe to conclude that metallic 94 is more volatile than uranium metal.

11/14/42

After preparing the chart yesterday on the program for obtaining the final product, I decided to write a memorandum to Compton to determine who will have the final responsibility for the last small-scale purification steps of 94^{239} . I am taking this precaution because otherwise the Army might assign the task to du Pont Company or some other organization which lacks chemists skilled in radiochemistry. The memorandum, entitled "Subject: Site X--Purification of Product," reads as follows:

"It is our understanding that no formal assignment of the responsibility for purifying the concentrated 94 has as yet been made. We have given the problem considerable thought and feel that it is one that cannot be left until plant operation is imminent. On the contrary, considerable development will be necessary, since the first purifications will be each in the nature of a chemical research problem to be carried out by remote control. It is obvious that the huge volumes of reagents and large scale of equipment compared with the size of the final product will introduce unpredictable impurities. So far our 94 extraction methods have dealt largely with the removal of only relatively pure 94 from large amounts of material, whereas in the final purification steps we will have to remove impurities that are present in amounts comparable with the amount of 94. The research work on the removal of the last small amounts of impurities can be done for each extraction process only on the final 94 concentrate itself since there is no way that we can duplicate these conditions beforehand. We believe that the actual manipulations in these last small scale purification steps should be done by the men most experienced in radiochemistry and 94 chemistry.

"It is our recommendation that this responsibility be assigned to the Metallurgical Project with the work to be carried out by our 94 Chemistry Group in the chemical laboratory at Site X and that the development work be started immediately in Chicago. It is further recommended that the development of suitable equipment to carry out these remote control separations be the joint responsibility of the 94 Chemistry Group and the Extraction Engineering Group. We believe that an early decision on this matter by Mr. Compton and/or by the Technical Council is advisable, so that a decision can be pressed for as soon as possible."

11/14/42

I received a phone call from Charles Cooper inquiring about the "Acetate Method" for separating 94 from fission products and uranium that, he said, has just learned is being developed at Berkeley. I said I haven't heard about it yet but I am sure it involves co-precipitating oxidized 94 with sodium uranyl acetate.

Allied troops have invaded Tunisia and are closing the pincers on Rommel. President Roosevelt announced that lend-lease aid will be granted to Africa.

Sunday, November 15, 1942

Helen and I went to Wrigley Field this afternoon to see the Chicago Bears-Green Bay Packers football game, which the Bears won 38-7. The weather was beautifully clear and warm--in the fifties--and as I sat there in the bleachers I thought how oblivious the crowd was to the feverish activity going on right then at another stadium, the outcome of which might determine whether we or the Germans will be the vanquishers in this terrible war. I have in mind the work at the squash court under the West Stands of Stagg Field, just one block north of Jones Laboratory.

Monday, November 16, 1942

Fermi believes he can achieve a chain-reaction with 400 tons of graphite, six tons of pure uranium metal and 50 tons of uranium oxide. At the current price for these materials, the total cost comes to almost exactly one million dollars. He is building the pile into a rough spherical shape, about 25 feet in diameter, in the West Stands just as he had planned to do at Argonne Forest. It is being assembled inside a huge balloon of rubberized canvas, one side of which has been peeled away. Later the balloon will be sealed around the structure, the air exhausted from it, and perhaps replaced with helium or carbon dioxide. The 400 tons of graphite are being sawn into bricks (approximately 4" x 4" x 16" on a side) right on the premises, and half of them are being drilled with

11/16/42

holes. Fermi estimates that he may need as many as 50,000 such bricks for the assembly. The pile assembly consists of layers of graphite bricks. Alternating layers are made of bricks with holes into which the uranium will be inserted. The uranium metal is being placed near the center of the pile structure, and the oxide is being compacted into lumps with a hand press and placed in the outer regions. I have seen some of the workers and they are covered from head to foot with graphite dust. Yet Fermi does not suffer for lack of volunteers to carry on the work far into the night. At the rate they are going, he may be able to beat his deadline of December 15, just a month from now.

Perlman and Knox ran through their modified "Wet Fluoride Method" in which barium sulfate is co-precipitated with the first lanthanum fluoride in order to determine whether this affects the yield of 94. In tracer experiments they carried through the entire oxidation-reduction cycle two times with barium sulfate precipitated with the first lanthanum fluoride and two times without. The average recovery for the former is 96% and for the latter 94%; so it may be concluded that the removal of barium sulfate when 94 is in its upper oxidized state does not result in a loss of 94.

After standing for three weeks, the 136 kg of UNH whose bombardment with neutrons ended on October 25, 1942 (Chicago II), was subjected to ether extraction, under the direction of Perlman and Jaffey, which resulted in reduction of the mass of UNH to 17.6 kg in 4 liters of solution. The material was not at all clean, containing bits of wood, paraffin and general debris. Assays made yesterday and today indicate that there are about 450 micrograms of 94^{239} in this 4 liters of solution on the basis of a specific alpha activity of 94^{239} of 165,000 alpha disintegrations per minute per microgram; that is, a 20,000 year half-life. This extraction was conducted in an available area in the North Stands rather than in the attic area of Jones Laboratory due to the difficulty of transporting such highly radioactive material up to the fourth floor. The continuing work of further concentration of the 94^{239} , through an additional ether extraction, will be carried out under Jaffey's direction and then the 94^{239} will be isolated in pure form from this concentrate by Cunningham and Werner.

11/16/42

Our report "Chemistry of 94. University of California and University of Chicago" for November 1-15, 1942 (No. CN-343), was completed today. It says that Willard and Turk, working on the adsorption method for separating 94, find that, when column size is increased from 1-2 centimeters diameter to 10 centimeters diameter, it is found impossible to elute more than 50% of the adsorbed 94 from the Hyflo Super Cel. This presents a problem which would have to be solved before this process could be put on an engineering scale. The report states that Cunningham and Werner have determined the solubility of plutonous phosphate in 5 M NaH_2PO_4 and find the solubility low enough to provide a possible method of separation of plutonium from zirconium, which dissolves completely in 5 M NaH_2PO_4 . The solubility of plutonium peroxide in acid solution has also been measured and found low enough to suggest the possibility of a purification procedure from rare earths based upon the precipitation and reprecipitation of the peroxide from acid solution. It reports that Kohman carried out a systematic investigation to determine optimum conditions of acidity and hydrogen peroxide concentration in the thorium peroxide precipitation method for separating 94. It also states that Magel and Cefola have conducted experiments to determine whether or not electrolysis of 94 into mercury will produce the metallic form of 94, using fairly pure 94 sulfate solution; the total amount deposited is not sufficient to distinguish between metal and oxide.

The report goes on to say that Thompson, continuing his study of the use of organic reagents for final stages of 94 purification and for separating 94 from 93, has tested sebacic and phenylarsonic acids. He finds that phenylarsonic acid is the most effective organic reagent found to date for separating 94 from 93; sebacic acid is rather unsatisfactory. He also reports on his continuing work on the phosphate method for separating 94. Using zirconium as the carrier, zirconium phosphate is precipitated from uranyl nitrate solution, dissolved in nitric acid and La^{+3} and HF added to precipitate lanthanum fluoride, which is found to contain 90% of the 94 tracer present originally. Other experiments show that this procedure gives good separation from fission products. Brown, Hill and Jaffey are reported to have tested the volatility of 94 fluoride using a weighable amount (0.2 microgram) of 94 oxide. They substantiated the conclusions reached earlier using tracer amounts of 94. Further study

11/16/42

of the chlorine method for isolating element 94 shows that the use of lanthanum as a holdback carrier is successful in preventing transfer of the 94 along with the UCl_5 , thus giving some hope that a chlorine process might be feasible. In another experiment UF_6 was successfully distilled out from UX_1 activity, indicating that direct fractional distillation of neutron-bombarded UF_6 would be a rapid way of separating element 94 and fission products from uranium. Our section of the report concludes by saying that Magel has heated pieces of neutron-bombarded metallic uranium to $1,890^\circ C$ in a high vacuum to test the volatility of metallic 94. It is found that the 94, present in tracer amounts, is more volatile than uranium metal.

In the Berkeley section of the report Garner and J. W. Kent report on "Volatility of 94, 93 and Uranium Compounds" and Prestwood and Sheline report on "Wet Fluoride Method."

During the last month the Chemical Engineering group under C. M. Cooper has continued the development of design information for three different 94^{239} extraction processes (Figures 23 and 24). As they envision a process, it will be large enough to handle one ton of metal per 24-hour day, and shielding will be adequate to care for material from Pile III. Material from later and higher radiation units can be handled by allowing a longer cooling-off period or by operating the extraction plant at a reduced output with more dilute solutions.

In choosing the process to be employed, the group is being guided by the following factors:

- (a) Is enough known about the process so that a plant can be designed and built in the time available?
- (b) How certain is the chemical information?
- (c) How adaptable is the process to remote control?
- (d) Can process wastes be handled safely?
- (e) Will the process be readily adaptable to the forms of uranium likely to be employed in future piles?

The group feels that of the processes worked on up to the present, the Wet Fluoride Process appears most attractive when judged by these factors, and studies in this connection are being pressed as rapidly as possible in the expectation that the basic design information will be

11/16/42

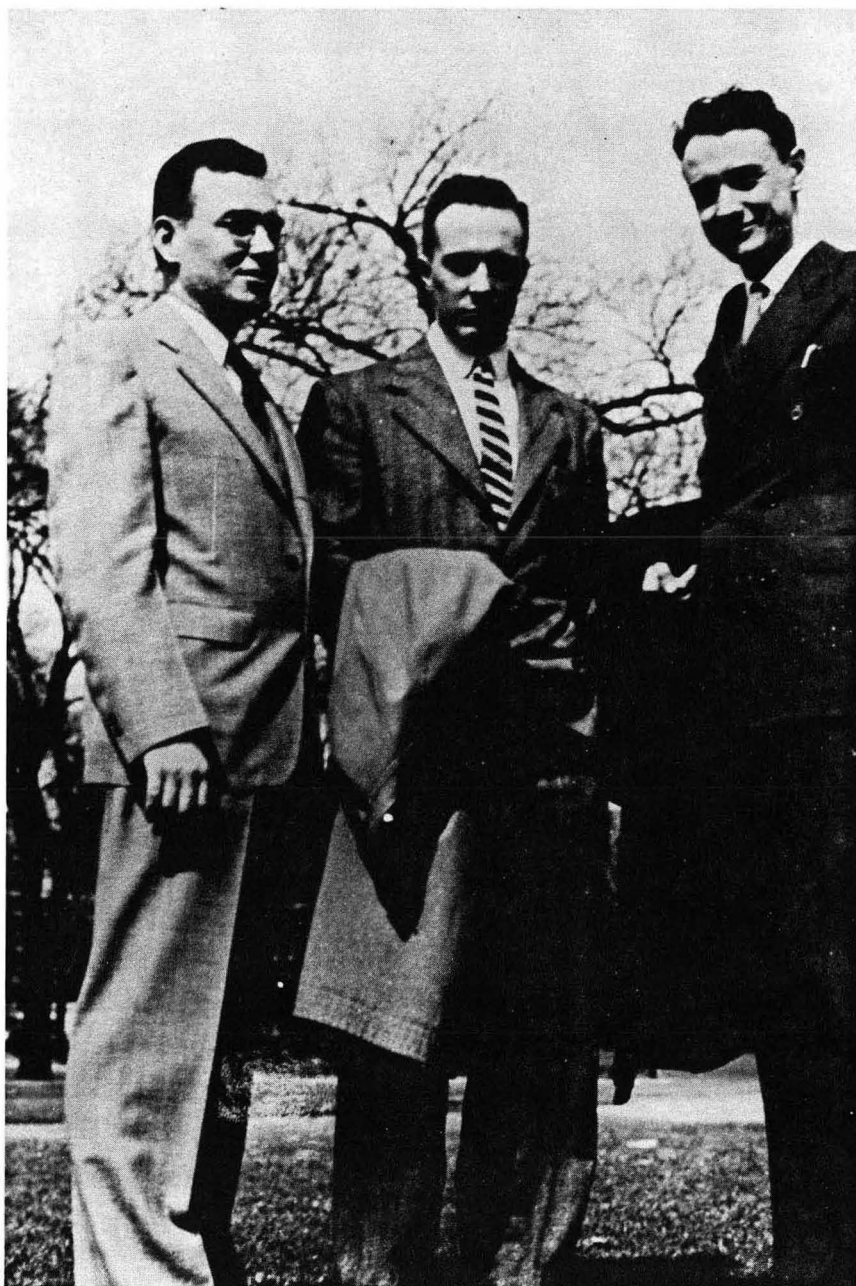

Fig. 23 Chemical engineers Dick Apple, Don Webster and Luther Peery (L-R) at Jackson Park, November 1942. (XBB 764-7444)

11/16/42



Fig. 24 Chemical engineers Luther Peery and Don Webster with Dan Koshland (L-R) at Jackson Park, November 1942. (XBB 764-7443)

11/16/42

completed early in December. The "peroxide" and "dry" methods are also receiving attention, which will increase as fluoride problems are worked out. The overriding consideration in choosing these processes is based on expediency.

Newspapers report that there are big battles on two fronts: in the Solomon Islands and at Bizerte (a big Tunisian naval base).

Tuesday, November 17, 1942

Thompson tested today the efficiency of removing fission products from the 94 in his zirconium phosphate method using some of the UNH from the second neutron bombardment at St. Louis (Chicago II). He repeated the procedure that he went through last Saturday and finds that about 40% of the total initial gamma activity is present in the zirconium phosphate precipitate (which is very roughly the expected amount for zirconium and columbium), and only about 3% of the initial gamma activity is found in the final lanthanum fluoride precipitate. This indicates that this method has good prospects for success.

This morning I received a telegram from Wahl requesting that a pound of the latest neutron-bombarded uranyl nitrate be sent to him immediately by air express. Covey shipped the sample tonight in a large cardboard box via Railway Express. Had the shipment with all the lead shielding been made by air, the cost would have been exorbitant.

I sent a telegram to Hamilton in Berkeley, replying to his telegram November 12, telling him to ship the bombarded thorium this week at his convenience.

One of the recommendations made by the du Pont team that met here early this month was that the Met Lab physicists design a heavy water (D_2O) chain-reacting pile. It must have been taken quite seriously because yesterday Allison, Christy, Manley, Szilard, Thiele, Wheeler and

11/17/42

Wigner held a meeting on the availability and moderating properties of heavy water.

In regard to the availability of heavy water, a private Canadian company, the Consolidated Mining and Smelting Company, located at Trail, British Columbia, is the largest producer of hydrogen on the American continent. It produces electrolytic hydrogen for its manufacture of ammonia and last month extracted an experimental batch of heavy water, 620 grams. The company now has a contract with the United States to produce D_2O in large amounts; and, after the new plant is completed next April 1 should be turning out about a half-ton of heavy water per month. Thiele said that production now might go up to a few liters per month prior to April 1. Allison then remarked that the Commission in Washington will have to decide whether we at the Met Lab or Halban at his new laboratory in Montreal will get it. The reply from Thiele was that Urey at Columbia is now getting all the heavy water produced—moreover, two letters were sent from Columbia to the Met Lab here, which brought no reply or display of interest in heavy water.

I have learned that yesterday the Technical Council held a special meeting to hear an accounting of Compton's trip to Washington last Saturday to attend a meeting of the S-1 Executive Committee which General Groves also attended. He gave a brief history of the search for an industry to take on the development of engineering for the Met Lab. In the spring, Stone and Webster agreed to handle engineering and construction. Because they could not contribute to process design, it was necessary to contact an experienced organization in August. The three companies contacted were du Pont, Standard Oil of New Jersey and Union Carbide and Carbon. All refused to get involved because of their preoccupation with war orders. In September, Dow Chemical, Monsanto and Alabama Eastern were considered, and they too turned down our request. The work was turned back to the Met Lab against Moore's advice.

Then General Groves asked du Pont to make an independent assessment of our process, including time schedules and approximate costs. After estimating that the probability for success of the operation is 50 percent now, and 80 percent if a chain-reaction can be produced in Pile I, they became interested and agreed to take on the partial responsibility for

11/17/42

internal construction, which will take the company completely out of any other military work. They will assign their best men to the job. Du Pont has a design staff of 200 engineers and 600 draftsmen, and 500 of these will be recruited for the Project. Groves discussed with Stone and Webster their partial replacement by du Pont, which they accepted with good grace. The Met Lab will continue as a research laboratory and provide essential data, including that required by du Pont. We will continue to operate under an OSRD contract, whereas du Pont will operate under an Army contract.

A discussion followed. Compton said that du Pont suggests that Allison be placed in first position and du Pont's representative, possibly Greenewalt, be placed second. For the next month or so, Cooper should be relieved of all other responsibilities so he can concentrate on the chemical separation process. Du Pont will take on the responsibility of constructing Pile II but will send observers during the erection of Pile I. They want to make Pile III as close as possible to the ultimate design, redesigning it to this end. They desire to concentrate on one or two possibilities. They consider helium as the number one possibility, followed by a homogenous heavy water plant. They rate bismuth cooling as third and water cooling as fourth.

At our Research Associates meeting this evening we discussed the decision by du Pont to play a central role in the production aspects of our Project. We are all quite pleased because we have learned to respect the abilities and to like the du Pont men already assigned to the Metallurgical Laboratory. We have established a very good working relationship with these chemical engineers.

The Japanese fled after a three-day battle at Guadalcanal.

Wednesday, November 18, 1942

Kohman has completed experiments with 93^{239} and 94^{239} tracers in which he precipitated a mixture of rare earth and thorium fluorides and then redissolved the thorium in 5 M NH_4F . He finds that the 93 and 94 redissolve

11/18/42

with the thorium and thus can be separated from the rare earth elements which remain in the undissolved rare earth precipitate.

Hamilton sent me a telegram from Berkeley, telling me that the bombarded sample of thorium is being shipped to us this morning.

I sent a telegram to Wahl, telling him the bombarded UNH was shipped last night by Railway Express. I explained that air express would have been too risky without sufficient lead shielding.

Like most of the other young men here at the Met Lab, the U.S. Army permits me to work on the project because of an occupational deferment granted by a draft board. In my case, I was given a 3B classification by Local Board No. 68 of Berkeley last May, along with Spofford G. English, Bernard G. Saunders and Fred H. Schmidt of the University of California, on the recommendation of the National Defense Research Committee, which is part of the Office of Scientific Research and Development. I reminded Doan, our Administrative Officer, that my case will be up for review by my draft board November 28, and he wrote a letter today to Wensel at OSRD in Washington, requesting a continuation. He said: "As you know, Dr. Seaborg is the Group Leader of one of our very important groups. He has been associated with our project since its inception and has developed the methods and techniques which are vital in the continuation of our research. The efficiency of the entire group which he heads is dependent upon the direction and knowledge of this man. As a chemist, Dr. Seaborg is outstanding. He is recognized as an authority in his specialized field of research. If his services were not available, we do not know where we would secure another man to take charge of his group. Since Dr. Seaborg is one of the few men in this country who are acquainted with the particular problems we are investigating, we must continue to have his services. Your aid in presenting these facts to his local draft board before November 28 will be greatly appreciated by us."

I received from Gofman a draft of a report written by him and Duffield covering their work during the last few months on the measurement of fast neutron fission cross sections. This work was started before I

11/18/42

left Berkeley, and I have kept in touch with it since. The draft report is entitled "Fast Ra-Be Neutron Fission Cross Sections of 94^{239} , U^{233} , U^{238} and Pa^{231} ." It is a follow-up to our earlier report on this subject, "Fission of 94^{239} and U^{233} by Fast Ra-Be Neutrons," by Friedlander, Gofman and me, issued as Report CF-221 on August 5.

Big American transport planes dropped British paratroopers behind the Axis lines in Tunisia.

Thursday, November 19, 1942

Today begins the irradiation at St. Louis of another 300 pounds of UNH with neutrons, the third such sample (Chicago III), which will continue for the next month or two. We also are including some uranium metal. This time we have asked for 100,000 microampere-hours, or more if possible, of bombardment with neutrons produced by deuterons on beryllium. The last UNH bombardment (Chicago II, ending October 25) was for a total of 100,000 microampere-hours of deuterons on beryllium.

At the meeting of the Chemistry Division Group Leaders et al. held in Room 209, Eckhart Hall, from 9:15-10:00 a.m. this morning, there were reports by Anderson, Borst, Coryell, Mitchell, Newton and Perlman. Anderson talked about relative yields of fission products and the importance of counting efficiencies in determining these. Then Coryell talked about the properties and fission yields of a number of short-lived isotopes. Perlman summarized the role of long-lived fission activities in the development of separation processes and emphasized the importance of the energies of their beta and gamma radiation. Borst also gave a report on the radiations from fission products. Newton summarized the work going on at Ames Laboratory on the determination of the characteristics of fission products and their diffusion from uranium metal, while Mitchell gave a summary of methods for the determination of gamma-ray energies of radioisotopes using coincidence counting techniques.

Tuesday and Wednesday some of the du Pont men met with Hilberry, Moore, Newson, Steinbach, Wheeler and Whitaker to discuss the drawings

for, and general status of, Pile II. To the surprise of our people, the du Pont men claimed that only 15 per cent of the drawings have been completed. The du Pont group expressed a strong desire that Pile II should serve as a pilot plant for Pile III. After considerable discussion it was agreed that a simplified helium-cooled design should be considered for Pile II, instead of its present design. The operation of Pile II would be delayed a month, but this would be offset by the fact that the output of 94^{239} would be raised from ten grams to 100 grams. Also time would be saved in case the helium cooled development proves to be impractical for some unforeseeable reason.

An important meeting of the Technical Council was held today. Members present were Allison, Compton, Fermi, Moore, Spedding, Szilard and Wigner. As their guests they invited Cantril, Cole, Doan, Hilberry and Whitaker. Compton announced that a special review committee appointed by General Groves will visit the Laboratory next Thursday and that we must prepare a report on the feasibility of our project for them. In brief, the meeting went as follows:

Compton: The committee will try to decide which of the three processes under the entire S-1 Project (calutron, pile and gaseous diffusion) can lead to a successful conclusion in a reasonable time. The committee, which will visit all three projects, will include industrial specialists on production problems. The feasibility of the use of our product and the feasibility of the process for producing our product will be discussed. An important question is the necessary purity of our final product and how likely we are to attain that purity. Another question that the committee would like to have discussed is the radioactivity of "49" and the consequent handling.

Szilard: Seaborg reports no gamma rays associated with the decay of 49.

Compton: Other points to be discussed are spontaneous heating of 49 and spontaneous neutrons from 49. Also the metallurgy of 94 is largely unknown but some guesses can be made. One advantage of our process is that larger quantities of our product can be made sooner than by any of the competing processes. The conclusion at Washington

is that production should go ahead. At Washington, the report made by the du Pont engineers who visited us during the week of November 2 was studied. This report stated that our process was far more difficult than the usual development put through by du Pont. Stine, vice president of du Pont, estimated the probability of coming through with such production in a reasonable time is only one percent! The big delays would be in development, health protection, and the necessary metallurgical studies. They considered that no successful engineering scheme has as yet been presented. The committee that will arrive on November 26 will include Dr. Murphree and Dr. W. K. Lewis. There is to be no slowing down on Piles I and II or on uranium metal production. There is about 1000 tons of uranium available in ore at the present in the United States. The du Pont Company favors a heavy water plant as one that would conserve uranium.

Allison: Would it not be well to take a representative of our project to Berkeley with the committee to answer questions about our project which might arise due to the committee's consideration of the Berkeley project?

Compton: The committee has asked me to come along on their trip and I would like to have a representative of the Council come with me.

Wigner: It seems unfortunate that the committee chosen to make this important decision does not include people familiar with the details of nuclear physics. The committee should include people like Lauritsen and Breit.

Compton: I am sure that the committee will take the advice which we give them on physical matters, and we should give them this advice as fully as we know how. On matters of remote control of the plant, disposal of waste products, heat transfers, etc., we must depend upon the judgment of the engineers.

Doan: Experience in the Phillips Petroleum Company indicates that at least two years is necessary to get into production after the fundamental research has been done, and this on processes much simpler and better known than ours.

Szilard: As far as materials are concerned, it would seem that

there is no competition between our project and the one in Berkeley. Therefore, if each one has the same, rather small, possibility of succeeding in time, both should be pushed.

Compton: But it may be that the two probabilities are not the same and that one is ten times the other, in which case it does not follow that both projects should be equally pushed.

Spedding: Is not the total sum of money spent on the whole project a negligible feature in the war program?

Compton: This is probably true, but it is not the point. A relatively large fraction of physicists of the country are engaged, and physicists are more valuable than money at the present time.

Allison: Should the military use of fission products be pointed out to the Committee?

Compton: General Groves is interested in all possible military uses of our products, but is not especially interested in power production.

Allison: If the purity problem in our product is very serious we might switch to 23 in which case the purity requirements may be less by a factor of 10.

Wigner: The factor is more nearly 20 than 10.

Compton: Oppenheimer says that the actual danger from neutrons produced from light impurities in our product may be 30 times less than indicated by the simplest type of calculations. Oppenheimer estimated that even one percent of oxygen would not cut the efficiency so low that the product would be unuseful.

Wigner: Studies of the fast neutron reaction are really just beginning. When the slow neutron studies were begun, there were as many and as serious difficulties as there seem to be coming up in the fast neutron case. Preceding indications would be that they can be solved.

Compton: This purity requirement apparently does not seriously affect the du Pont judgment on our process.

Wigner: The du Pont estimate of the probability of success is only too true if the present arrangement continues, that is, with poor contacts between physicists and engineers.

Compton: Comments such as Wigner has just made are exactly

what the committee would want to hear and should be put in memorandum form.

Szilard: One possible way of getting rid of O^{17} , O^{18} is to wash out with a small amount of pure C^{16} . The same trick might work in getting rid of C^{13} .

Compton: Let us consider the outline of a report to be presented to the investigating committee. I would like to have this report in my office on Monday morning, November 23. We should have a meeting on Wednesday to go over the report after my preliminary revisions. In certain cases, it might be well to indicate briefly the history of the development of the topic being discussed. Wherever possible, the topic should be discussed from the point of view of feasibility, giving our estimate of the likelihood of success in meeting the requirements.

Compton then presented an outline of the report he will present to the review committee. It had the following form:

- | | |
|--|-------------------|
| A. The Chain Reaction Itself | |
| 1. Will reaction be self-sustaining? | |
| 2. Will reaction be thermally stable? | FERMI |
| 3. Will reaction be controllable? | 10 pages |
| B. Possibility of Removing Heat | |
| 1. Overall requirements | MOORE--7 pages |
| 2. Lattice Conditions | |
| a. General statement | WIGNER--3 pages |
| b. He-cooled plant | LEVERETT--3 pages |
| c. H_2O -cooled plant | YOUNG--3 pages |
| d. Bi-cooled plant | SZILARD--3 pages |
| e. D_2O plant | WIGNER--3 pages |
| 3. Technical problems | |
| a. Corrosion | HOWE--2 pages |
| b. Metallurgy | CREUTZ--2 pages |
| C. Extraction and Preparation of Final Product | |
| 1. Extraction | VAUGHAN--3 pages |
| 2. Purification | SEABORG--4 pages |
| 3. Metallurgy of "49" | SPEDDING--1 page |

11/19/42

D. Health Hazards	CANTRIL
1. Radiation shielding	FRIEDMAN-FAILLA--2 pages
2. Effect of radioactive gases and fission products	COLE
3. Radioactivity of "49"	CANTRIL
E. Estimates of Times and Costs	HILBERRY
F. Usefulness of Ultimate Product and of Process	COMPTON
1. Main application	TELLER
2. Radioactive materials	STEARNS
3. Utilization of power	WHITAKER
4. Use of enriched material	WEINBERG
5. Production of other new substances	MULLIKEN
G. Comparison with "25"	CHRISTY
1. Yield of "49" per ton	
2. Possibility of conservation of uranium	

Friday, November 20, 1942

The big news today is that a draft of a Project Feasibility Report for use by a special review committee is due by Monday and that Perlman and I will be responsible for a substantial portion of it. Hilberry will put the report together from the various inputs from people throughout the Laboratory.

English has isolated three fractions of 94^{239} from the 100.0 cc solution containing 93^{239} set up by James on September 15, which in the meantime has decayed completely to daughter 94^{239} , and measured the intensity of alpha particles in each. Then using the initial intensity of 93^{239} , a value of 2.08 for the ratio of conversion electrons plus beta particles to beta particles of 93^{239} (obtained by Wahl in experiments at Berkeley last December), the final intensity of daughter 94^{239} alpha particles and the appropriate geometrical factors for the detection of the radiation, he comes out with the three values for the half-life of 94^{239} of 18,300 years, 17,900 years and 17,500 years.

11/20/42

Willard and Turk have performed experiments on the microscale to investigate the ability of Hyflo Super Cel to adsorb 94 at the higher concentrations that would exist in a commercial extraction plant. They find that 94 can be over 85% adsorbed by Hyflo Super Cel from solutions containing 4 mg of 94 per liter and 5% of UNH by weight, and that the 94 can be as effectively eluted with a solution 3 M in HCl and 0.36 M in NaH_2PO_4 as by 6 M HCl. Earlier experiments have shown that the use of phosphate appears to elute less of the fission activity and is therefore preferable to HCl alone.

I wrote a letter to Gofman today that was different from the kind I usually write to him. I asked him to leave the project in Berkeley and come to work for us here at the Met Lab. "The work here at Chicago," I said, "is reaching the stage where I feel that I need another person in the group here who knows a great deal about nearly all the problems involved—49, 23, 24, slow and fast neutrons, nuclear physics in general, etc." I said that Latimer is here today and that I have talked to him about it and received his agreement. Gofman is in the process of writing his Ph.D. thesis. I suggested that if he arrived here around January 1 he probably would have time to finish it before leaving Berkeley. My offer concluded with the remarks: "I know that such a move as this would dislocate personal life a great deal, but I do need your help very much and I really hope that you will be able to see your way clear to come. Please let me know as soon as possible how you feel about this."

Another matter of my letter to Gofman related to the draft report that he sent me on his and Duffield's work on fast neutron fission cross sections. I complimented them on their very fine job and said that it is certainly all right with me if they want to include Charles Blanchard as an author in view of his help with the counting equipment that they used.

Saturday, November 21, 1942

Foster York, the patent attorney here, admits he has learned a great deal more about the work at the laboratory and so decided to rewrite the patent specifications for U^{233} . I wrote Gofman another letter today,

11/21/42

saying that in view of the changes, York wants Gofman and me to read the case and sign it again. I informed Gofman that York will be in Berkeley next Monday and Tuesday and will call on him to pick up the signed papers, which are being sent to Gofman.

Perlman and I have been busy writing our contribution to the feasibility report that will be presented to the special investigative committee arriving next Thursday. We finished it today, and I personally took it to Compton's office to give it to Hilberry.

We have called our section "Extraction and Preparation of Final Product." In this we describe the discovery and early work at Berkeley on element 94 and point out that up to the present time about 500 micrograms of 94^{239} have been obtained in the form of pure 94 salts (i.e., without "carrier" material). With this it has been possible to determine the solubility of key 94 compounds and the important volatility properties of 94 compounds for use in connection with the separation processes that we are developing. In our section of the report, Cooper and Smith have a subsection on methods for the extraction of 94 in which they describe the Wet Fluoride Method, the Peroxide Method and the Dry Fluoride Volatility Method in terms of scale-up to operating conditions on the full plant scale. Perlman and I conclude our section with a description of the required final purification and reduction to the metal of the 94. We indicate that following the extraction and decontamination of the 94 through the operation of a chemical procedure by remote control (to protect from the radiation of the fission products) on a plant scale, it will be necessary to further separate the 94 from fission products on a laboratory scale and then isolate the pure material. We indicate that the precipitation of pure 94 peroxide from acid solution might offer a procedure for this final isolation step. An alternate procedure is the separation of the higher fluoride of 94 by a volatilization process.

We point out that the most difficult step in the whole process of separating and isolating 94 is the removal of the light element impurities from which a dangerous number of neutrons might be produced through the action of 94^{239} alpha particles. The most dangerous elements, i.e., those that must be removed the most thoroughly, will be lithium, boron and beryllium. These cannot be tolerated in the final 94^{239} in concentrations

11/21/42

exceeding from 1-5 parts per 10 million. Oxygen and carbon may also prove troublesome, but these can be tolerated to the extent of about one part in 10^4 and 10^5 respectively. Fluorine can be tolerated in concentrations to the extent of five parts in 10^6 . The restrictions on heavier elements are not so stringent because the alpha particles from 94^{239} have decreasing ability to produce neutrons in reactions with them. The preparation of 94 metal, the form required in the nuclear weapon, at such high levels of purity will be difficult, but we know that metallic 94 will resemble uranium and that methods suitable for the production of metallic uranium can probably be applied. These include the reduction of 94 oxide or a 94 halide with an alkali or alkaline earth metal or by electrolysis of a fused halide. The final metal production step might involve the reduction of a heavy halide of 94 (e.g., the bromide) with a heavy metallic reducing agent (e.g., barium). The reduction might be carried out in a heavy unreactive refractory material (e.g., tantalum) in a high vacuum. The feasibility of such reduction methods can probably be demonstrated by performing experiments with microgram amounts of 94^{239} before gram amounts are available.

In our discussion Perlman and I indicate that we feel that the extraction, decontamination and purification and reduction to the metal in the required extremely high purity will be feasible although it will require a substantial research effort.

Latimer is in town, and I have spent a good deal of time with him discussing the difficult 94 purification problem and reviewing the work of our Chicago and California groups.

Sunday, November 22, 1942

The Sun contains a big article about U.S. and Australian troops, the troops have moved into three miles of Buna, the main Japanese base on New Guinea's north shore.

Monday, November 23, 1942

Compton showed me a memorandum dated November 20 that he just received from James B. Conant, who is Chairman of the S-1 Executive Committee. The other members of the Committee, Briggs, Lawrence and Murphree, also were sent copies. It pertains to the matter of the purification of 49 required to prevent the production of neutrons from light element impurities.

At the November 14 meeting of the S-1 Executive Committee that Compton attended, Conant told Compton that on that very day he had had lunch with Wallace A. Akers, his British counterpart; and to his chagrin he was informed that James Chadwick had recently concluded that 94 could not be used as bomb material because of its alpha emission. Compton explained to Conant that I had become aware of the problem earlier and had already discussed it with Oppenheimer. Conant was not placated; he reported Akers' news to Groves, who then appointed an investigative committee of Compton, Oppenheimer, Lawrence and McMillan. The committee reported back that the necessary purity of the product could be met. This did not satisfy Conant when he compared their figures with Chadwick's, and because of this he and Groves appointed the review committee, the one for which we are preparing the feasibility report. Conant's memorandum to the S-1 Executive Committee members (Briggs, Compton, Lawrence, Murphree) is most interesting to read because it shows his state of anxiety. It reads as follows:

"This is in the nature of a report on certain events which have happened rather rapidly since the last meeting of the Committee and about which the members should be informed.

"As General Groves reported at the last meeting, he was in process of having the work at Chicago reviewed by the du Pont Company, not only from the point of view of chemical engineering but from the point of view of the practicability of the entire procedure. At the same time at which the du Pont Company made this report, an unexpected difficulty was brought to my attention. Independently, through Mr. Akers and through Dr. Lawrence, I learned of the fact that both in England and in the United States serious doubts had arisen as to the practicability of using element 94. This depended on the fact that unless the purity was extremely high in respect

11/23/42

to the light elements there would be difficulty in the actual construction of the bomb because of the neutrons which would be given off as a consequence of the high alpha activity of 49, coupled with the presence of such light elements as beryllium, boron, carbon and oxygen. As soon as I reported this difficulty to General Groves (after a conference Saturday night with A. H. Compton and E. O. Lawrence), he assembled an ad hoc committee composed of Lawrence, Compton, Oppenheimer and McMillan, who rendered a report on this new aspect of the problem. In this report was recorded Mr. Oppenheimer's opinion as to the desirable purity of element 49 and the absolute requirement. In each case, this last was approximately 0.10 percent for the lighter elements (except O and C which could be 1%); the former value (the desirable) a hundredth or thousandth part of these. The desirable purity is such as to produce the maximum effect, and the absolute requirement is that which will produce an effect equal to a thousand tons of TNT. I hope very much that Dr. Compton and Dr. Lawrence will supplement these estimates by estimates of their own. The introduction of the specification of high purity for element 49, coupled with the none too optimistic report by the du Pont Company, made General Groves and myself feel that we must have a special committee of engineers review the entire Chicago program in the light of the present status of the electromagnetic program and the diffusion process. General Groves has therefore appointed a committee composed of Dr. Warren K. Lewis (Chairman), Mr. E. V. Murphree, Mr. Roger Williams, Mr. C. H. Greenewalt and Mr. T. C. Gary. (The last three are employees of the du Pont Company, but are acting as individuals on this committee.) This committee will visit Berkeley, California, New York and Chicago and render a report on the practicability of the Chicago project and the desirability of pushing it at high priority in light of the progress of the other two procedures. They will consider not only the present plans of the Chicago group but the possibility of going to a procedure using large quantities of heavy water and the production of the same by an immediate contract for the installation of large equipment along the lines discussed at the last meeting of the S-1 Executive Committee. It will be expected that this special reviewing committee will report in the course of the next two weeks, and the decision made as to plans for development and production will depend largely on their report.

11/23/42

"I hardly need point out that the sudden introduction of a new specification in regard to the purity of element 94 has been a very embarrassing feature. All of us on the S-1 Executive Committee must share the blame for what might have been an extremely serious situation and what has been at least an extremely embarrassing one. There is little use of reviewing errors of the past, except in so far as they throw light on procedure for the future. I do urge, however, each member of the Executive Committee to reconsider all aspects of the program in which he is in any way an expert so as to discover if there are other hidden and forgotten factors which should be brought to light now rather than when it is too late."

The Russian front is back in the news today as the Soviets made good gains against the Nazis on the 91st day of the siege of Stalingrad.

Tuesday, November 24, 1942

The second cycle of the ether extraction of the 136 kilograms of neutron-irradiated UNH (Chicago II), being carried out in the room adjoining the Chicago cyclotron, is well along under Jaffey's direction. The aqueous concentrate from the second ether extraction cycle should be available to Cunningham and Werner in about a week. The cyclotron is located in the nearby Service Building and an available room in this building has been outfitted with the necessary utilities to carry out this work. It is planned to have this area also serve as the location of the semiworks of the chemical engineers where they will make their tests of the Wet Fluoride Process, etc., on the semiworks scale.

Compton has issued his "Metallurgical Project Report for Month Ending November 15, 1942." Actually, the work of the Project is surveyed in nine separate reports. I will list their titles, along with the topics discussed, because they give a good bird's-eye view of what is taking place in the Met Lab today.

11/24/42

Chemistry of 93 and 94

This is represented by our last two semi-monthly reports, including the work of Latimer and his group in Berkeley.

Chemistry

Analysis of materials

Details of analytical procedures

Preparation of UCl_4 , UCl_3 , properties of UCl_3

Effects of electron and deuteron irradiation on materials, and corrosion of metals by cooling fluids

Beta and gamma activities of fission products, total and element by element, as functions of time

Diffusion of fission products from cast metal at $600^{\circ}C$ and $1,000^{\circ}C$

Coatings for uranium

Physics

Initiation of construction on first operating pile

Experimental and theoretical work on multiplication factor and pile design

Preliminary engineering designs for water-cooled pile

Improvements and greatly increased intensity of Chicago cyclotron

Measurements of beta and gamma ray energies of radioactive pile products: Zr, La, U^{233} , 93^{239}

Personnel

Brief biographies of new Research Associates

Development of Extraction Plant Design

Design work on the Wet Fluoride, Ether Extraction and Peroxide Processes

Health, Protection and Radiation

Health hazards from uranium poisoning and from radiation

Animal experimentation with uranium and with fission products

Safety measures taken

Engineering and Construction

Approaching completion of Ingleside Laboratory

Argonne Forest building for experimental pile

Technology

Fabrication of uranium by casting, forging and other methods
Metallurgy and metallography of uranium
Production and casting of uranium at Ames
Casting and cutting of uranium at M.I.T. and Beverly
Coating uranium
Lined graphite and uranium tubes

Materials

Progress on commercial production of materials for piles
Heavy water
Plans in connection with Site X

Fast Neutron Work

Report of experimental investigations at Chicago and affiliated laboratories related to design of a "small scale device."

Highlights of the Laboratory's activities for the month were written up as follows:

"Construction and development of piles.—The structural plans for experimental piles 1, 2 and 3 remain essentially as described last month. Because of delay in the completion of the Argonne laboratory, however, pile number 1 is being built in Chicago. Construction began November 16 and proceeded rapidly. The structure will consist approximately of 26-foot sphere of graphite containing metal and oxide, inscribed in a cube, the corners being filled with wood blocks. Surrounding the whole is a balloon cloth envelope, 25 x 25 x 23 feet, which will permit evacuation of air and refilling with carbon dioxide. Alarm circuits and equipment for maintaining the neutron density are ready, and the two of the four control rods are ready. Although in the present location operation of this pile must not be at more than nominal power, it is hoped that most of the desired results can be obtained. Later the structure can be moved to the Argonne laboratory, which should be ready by January 1.

"Experiments with exponential piles have continued. Danger coefficients for fluorine (0.008), bismuth (0.007), and paraffin (1.0) have been measured.

"Preliminary engineering plans for a water-cooled pile have been developed in some detail. Several arrangements using internally or

11/24/42

externally cooled uranium pipes with protective coatings are being considered. Very recently attention has been directed toward the development of engineering plans for a pile using heavy water instead of graphite as a neutron slower. Such a heavy water pile could be much smaller than the graphite piles hitherto planned. It would yield a large supply of stray neutrons. Methods to utilize stray neutrons from operating piles are being studied.

"Production and delivery of materials.—Production and distribution of uranium oxide has continued about the same as a month ago, totalling a ton a day of purified dioxide. Fluoride production has increased by about one third. Calcium shipped to Ames for use in uranium metal production has doubled. "Metal cubes were produced and shipped to Chicago by Westinghouse at about the same rate as last month. Metal production at Metal Hydrides has increased, and cast metal is now being produced in considerable quantities. At Ames, cast metal yields have improved and rates of production are increasing very rapidly. Experiments indicate that, if necessary, magnesium can be substituted for calcium in the production of uranium metal at Ames.

"Steps have been taken to ensure increased production of all materials during 1943.

"Metallurgy and protective coatings.—Much progress has been made in the metallurgy of uranium at Chicago, Ames, M.I.T. and elsewhere, and future plans are developing rapidly. Experience in casting and forging, and with cutting, has been accumulated. Metallographic studies have been made; electrolytic etching was successfully used. Two transition temperatures of the metal below its melting point have been determined. Progress has been made on protective metallic coatings for uranium, and in producing metallic linings in uranium and in graphite.

"New Isotopes.—Work on methods of separation of 94 is being continued. Development of design information for three of the most immediately promising types of extraction process is being continued by the chemical engineers, for handling one ton of metal per 24 hours. By bombardment of thorium with deuterons at Berkeley, the new isotope Pa²³² has been produced. This decays with a half-life 1.6 days into U²³², an alpha-emitter with half-life about 30 years. This U²³² will be extremely

11/24/42

useful for tracing very small amounts of uranium, e.g., in the work of the health group.

"Properties, Separation and Use of Products.--Further knowledge has been gained of the chemical properties of 93 and 94. Work with easily visible samples of 94 is now commonplace and is being used to check results obtained by tracer methods. Solubilities of various compounds were roughly determined. Precipitation of $\text{Pu}(\text{IO}_3)_4$ verified the valence four for plutonium 94. Work on electrolysis of 94 is being continued. Volatilities of the metal and halides have been studied. Elimination of fission products must be carried extremely far under remote control in order to cut down hazards from gamma radiation.

"Progress has been made toward a more detailed knowledge of the radioactive fission products, both as to their chemical separation and as to their radiations and half-lives. New and important long-lived Zr and Cb activities with strong gamma activity were reported recently.

"The reactions of heavy nuclei with fast neutrons were the objects of continued experimental investigation during the past month in preparation for the design of a 'small scale device.'

"Health Division.--Organization is practically complete, and studies of hazards and protective measures are advancing. Protective measures against uranium poisoning are in effect or being undertaken at the industrial plants supplying materials and at the laboratories connected with the project. Animal experimentation on effects of irradiation, of ingestion of fission products, and/or uranium poisoning are under way at Chicago and Berkeley. Available experience of hospitals and of the National Cancer Institute on the effects of x-rays and gamma-rays is also being used."

Friedlander wrote to me from Moscow, Idaho, where he is an instructor at the University of Idaho in the Department of Chemistry and Chemical Engineering. It was the first time I had heard from him since he left Berkeley. He likes the University even though there are the inevitable disadvantages of a small town and small school. He said that his colleagues are all very nice; and, since the chemistry department is the largest in the University, even the research funds are not as low as he had expected. He was delighted to meet Theodore Winnick, an assistant

11/24/42

professor of biochemistry there, whom I instructed in my role as a student assistant to Professor William R. Crowell in his Quantitative Analysis class at UCLA and who took his Ph.D. under David Greenberg at Berkeley. Winnick is very much interested in tracer techniques with radioactive isotopes and Friedlander has hopes that he can become involved in tracer studies also if he stays on. He wondered if anything new had developed with respect to his security clearance and stated that he would like to be employed by a defense project where he could be more useful.

I directed a short memorandum to Stearns, in his role as Sub-Project Leader at Argonne, requesting that arrangements be made to produce some of our product in Fermi's pile I after it is moved to Argonne. To have, I wrote, even a milligram or so would be extremely useful in our development work for the final purification and reduction to metal; if the pile were run so as to produce the order of a milligram of product per ton of uranium, then this would be sufficient to make the extraction feasible with readily available facilities.

At my group's Research Associates meeting this evening there was a good deal of discussion of the planned visit of the special review committee and the feasibility report that is being prepared for their use. Despite the short time schedule, it appears the report will be ready in time for Thursday's meeting with the committee.

Wednesday, November 25, 1942

Continuing his experiments on the distillation of 94 metal from metallic uranium in a vacuum, Magel has shown that at $2,000^{\circ}\text{C}$, 94 has a vapor pressure about 100 times greater than that of uranium, or of the order of magnitude of 10 mm of mercury. Distillation was carried out in a radiation furnace in which the uranium was visibly molten. The distillate was collected on a tantalum condenser tube and analyzed for U and 94 . There was present in the distillate 1.6 mg or 0.5% of the uranium and 70 counts/minute or 50% of the $^{94}{}^{239}$. In other words, the ratio of 94 to uranium had increased in the distillate by a factor of 100 over that in the

11/25/42

undistilled 94-uranium metal. Assuming that the laws of perfect solutions apply to these tracer concentrations, and accepting 0.1 mm mercury as the vapor pressure of uranium at 2,000°C, the vapor pressure of 94 would then be about 10 mm mercury.

I was invited to attend the meeting of the Technical Council today in view of the current concern over the 94 purification problems and my role in exposing this problem. The main purpose of the meeting was to get ready for the meeting with the review committee tomorrow. Also present were Allison, Cantril, Christy, Cole, Compton, Cooper, Fermi, Hilberry, Moore, Mulliken, Colonel Nichols, Captain Peterson, Spedding, Stearns, Szilard, Wheeler, Whitaker and Wigner.

The first thing Compton talked about was the disturbed letter he has received from Conant. He informed us that the special review committee headed by Warren K. Lewis will make its final report in two weeks to recommend whether or not the Met Lab should continue in the race to make fissionable material. He then wrote a list of elements on the blackboard showing the required purity of 94²³⁹, in parts per million of the impurity, to make a bomb feasible, as ascertained by Manley, Oppenheimer, Teller and Robert Serber; he also listed the purity of the uranium metal produced at Ames Laboratory to illustrate the feasibility of purifying a metal very similar in its properties to 94.

	<u>94</u>	<u>Uranium</u>
Be	0.1	absent
Li	0.5	absent
B	0.2	<0.5
C	20	900
O	100	no analysis
F	5	no analysis
Na	20	absent
Mg	100	20
Al	20	absent
Si	500	20
P	100	no analysis

11/25/42

It is believed that these amounts are such that if only one is present, there will be a 99.5 percent probability of a successful device; whereas if all are present, there is a 50 percent probability of energy release greater than 10,000 tons of TNT.

There followed a discussion as to how the uranium that goes into a pile can be purified as a model for the purification of 94. Allison said that we are almost at the specified stage of purity, except for carbon and oxygen, and Spedding remarked that it would be difficult to reduce these contaminants to the required level. Szilard thought that perhaps the BeO or graphite crucibles used for casting 94 could be made from O^{16} or C^{12} , thus getting rid of O^{17} and C^{13} , the isotopes of oxygen and carbon that give off neutrons in the α, n reaction. Fermi suggested evacuation as a way to eliminate oxygen. Because nothing with an atomic number over 29 has to be considered for an α, n reaction, I said why not modify the metal production process by substituting heavy elements for light elements, e.g., bromine instead of fluorine, barium instead of magnesium or calcium? As for the refractory used for the reduction reaction and casting of the final product, 94 metal, it could be made from a heavy element, such as tantalum. I pointed out that any of the processes we use will not require that they be conducted on a chemical engineering scale. A guess was made by Allison that the probability of solving the problem of purification in two years is only ten percent. I countered with my own estimate. I said that if we can't do it in six months, then the chance is small of doing so in two years; however, the chance of solving the problem in six months is 50 percent. Spedding was even more optimistic and quoted 75 percent.

After a general discussion comparing the problem of purifying 94 with the problem of purifying uranium, Compton indicated we should be in a position to try out the various purification methods on a gram scale next summer, followed on a bigger scale nine months later. I pointed out that the real test for purity will come when the neutron output resulting from the α, n reaction on the contaminants is measured. Fermi estimated that ten grams of 94 would be sufficient to give an observable number of neutrons, based on a statement by Christy that 30 kilograms of 94 must emit no more than 10,000 neutrons per second. Compton reminded us that the device should require only 10 kg of 94. In Cooper's opinion, which agrees with mine, there is a good chance of getting the desired purity of 94 in six

11/25/42

months. He wanted to know how long it will take to get enough 94 to make a test. To this query, Compton gave us a new time-schedule for pile operations. Pile I: proof of chain reaction, December 15; thermal test, January 15; flash test, March 15. Pile II (if a few-hundred-kw pile): June-July, 10-50 grams ready for extraction. If revised helium-cooled design: July-September, 200-500 grams ready for extraction. I told the group that if the time difference between operation of the two versions of Pile II is four months, then I favor an earlier delivery of 50 grams; but, if the time difference is only two months, then I favor waiting for the delivery of 500 grams. I then asked Fermi if it would be possible to get milligram quantities from pile I, and he answered that perhaps so to the extent of one milligram per day (i.e., 1 kw for a month).

The meeting turned to a discussion of the relative merits of heavy water versus helium-cooled piles for the production plant. Later on I suggested that it would be desirable to push production of U^{233} inasmuch as uranium metallurgy is already understood and U^{233} could stand ten times as many impurities as $^{94}{}^{239}$; moreover, its nuclear properties are as well known. Its production rate is less than that of $^{94}{}^{239}$, but a heavy water pile would help decrease this disadvantage.

Compton said that there are seven problems that now confront us at the Met Lab. He described them as follows:

1. Controllable, self-sustaining chain reaction. (Fermi estimates 90% chance of success.)
2. Adequate amounts of primary material. (Given enough time, the chance of success is 100%.)
3. Operation at adequate power output. (Moore estimates 80% chance for helium plant; Wigner estimates 50% for any plant.)
4. Extract and purify $^{94}{}^{239}$. (Cooper, Spedding and I agreed that there is a 95% chance of extraction, 85% chance of purification.)
5. Maintain health and safety.
6. Produce useful product from $^{94}{}^{239}$. (Compton estimates a 90% chance.)
7. Accomplish within time to be of military value. (Compton said the chance is 100% by the end of 1945.)

By multiplying these probabilities, Compton gave a figure of 52 percent as the chance of success with the overall program. He concluded

11/25/42

the meeting by saying that we should be able to produce 500 grams of plutonium next year, achieve a small-scale device the following year, and in 1945 turn out one device per month.

Russians continue to make gains against the Nazis in the 93rd day of the siege of Stalingrad.

Thursday, November 26, 1942

Today is Thanksgiving Day.

It was a big day for the Metallurgical Laboratory. The Lewis review committee showed up this morning as expected, and I attended the all-day meeting in Eckhart Hall. The committee members present other than W. K. Lewis were all du Pont men: Crawford H. Greenewalt represented research; T. C. Gary, engineering and construction; and Roger Williams, plant operation. Eger Murphree was absent because of illness.

Compton had ready the feasibility report. He gave a copy to each of the committee members and most of the day was spent by the authors in giving oral reports from it. Allison, Compton, Fermi and Oppenheimer were asked to give independent estimates of the probability that bombs made of ${}_{94}^{239}\text{Pu}$ or ${}_{94}^{235}\text{Pu}$ will give the large explosions that have been promised; they each gave estimates of a probability of 90% or higher. Cooper and I were asked to assess the possibility of devising and operating a chemical process for separating 94 from uranium and fission products, and we both gave very optimistic replies. When I was asked for my estimate of the probability that 94 could be separated from light element impurities to the extraordinary degree required, I was more cautious but I held out good hope that it could be done and on a time scale that would give us the purified 94 in time to be useful. Here my caveat was that we must be allowed to employ the substantial number of chemists and metallurgists that will be needed to carry out the required research. Bob Christy and some others of us caused some commotion and consternation when we pointed out that the 94 in some of the solutions in the chemical extraction plant might be at a high enough concentration to cause a chain reaction; I

11/26/42

promised to look into this and submit a supplement to the feasibility report dealing with this aspect.

The meeting was packed with action and lasted all day. For our lunch Thanksgiving Day turkey was brought in and served at the conference table.

Our "Report on the Feasibility of the '49' Project" was a large and impressive document running nearly 150 pages. The introductory section, written by Arthur H. Compton himself, states the conclusions of the report as follows:

"SUMMARY

"PRODUCTION OF ALLOY '49' IN QUALITY AND QUANTITY OF MILITARY VALUE, FOLLOWING PROCEDURES NOW IN HAND, IS PROBABLY FEASIBLE (CHANCES BETTER THAN EVEN). AS PRODUCED, THIS ALLOY CAN BE USED FOR MAKING SUCCESSFUL SUPER BOMBS (PROBABILITY 90 PER CENT). THE TIME SCHEDULE, ASSUMING CONTINUED FULL SUPPORT, IS: THE FIRST HALF KILOGRAM OF CRUDE '49' IN 1943, THE FIRST BOMB IN 1944, PRODUCTION RATE OF ONE BOMB PER MONTH REACHED IN 1945.

"With regard to feasibility, our views are unanimous. As to dates, our estimates, based upon different procedures, vary from one bomb per month by January 1, 1944, to one per month by January 1946.

"GENERAL FEATURES OF THE PROCESS FOR PRODUCING '49'

"Element 94-239, called in our laboratory 'Plutonium,' (Pu) or by the code name '49,' is produced by allowing a uranium-238 atom to absorb a neutron, and then emit 2 beta particles. Our present supply (about half a milligram) of this artificially prepared transuranic element comes from bathing uranium salts in the neutrons from cyclotrons, followed by chemical extraction.

"It is proposed to make '49' in much larger quantities by producing a fission reaction with uranium that will be self-sustaining. When the fission of a uranium atom occurs, two atoms of roughly half its mass split apart with high energy (the fission products), and various radiations are emitted. These radiations include neutrons averaging about 2.25 emitted at each process. Roughly speaking, one of these neutrons will be caught by a second U-235 atom to produce the next fission stages, while the remaining neutrons are caught by the heavier U-in time changes to '49.'

"To prepare '49' by this process requires thus a unit in which fission chain reaction occurs, called the 'pile,' and an extraction plant in which the '49' will be separated from the parent uranium and from the highly radioactive fission by products.

"It is expected that the '49' will appear as a metal with much the same chemical and physical properties as uranium. Like uranium-235, it is subject to fission on capturing neutrons with thermal energies. It should thus be of value for making fission power units of various types, including bombs.

"Our laboratory has centered its investigations about seven critical problems that need to be solved to make the '49' project feasible. Our report includes statements on each of these questions written by men who have been working on them. The problems are:

- "1. To determine the conditions for a controlled, self-sustaining reaction.
- "2. To secure adequate amounts of primary materials of sufficient purity.
- "3. To develop methods for operating the reaction at large powers, and to put these methods in operation.
- "4. To extract and purify the '49.'
- "5. To maintain health and safety during the process.
- "6. To produce useful bombs of the '49.'
- "7. To accomplish these results in time to be of military significance.

"The feasibility of the '49' project is identical with the satisfactory solution of these seven problems. Sufficient progress has been made with every problem to give us confidence that it can probably be solved."

The body of the report consists of sections written by the people responsible for various phases of the program and speaks to the seven points listed in Compton's introduction. It includes our contribution, Section D, finally entitled "Can the 49 be Extracted, Purified and Reduced to the Metal" with an "Introduction" by Perlman and me, a part on "Extraction of 49" by C. M. Cooper and W. Q. Smith, a part on "Purification and Reduction to Metal" by Perlman and me and a short paragraph on by Spedding.

11/26/42

The meeting seemed to go very well; and I am confident, from the nature of the comments and remarks that were made by the Review Committee members, that their report will be favorable. I am particularly well impressed by the general grasp and understanding that Greenewalt has already acquired as evidenced by his penetrating questions.

After the day-long meetings, Helen and I met at Alice and Stan Thompson's (5416 S. Woodlawn Avenue) for a never-to-be forgotten Thanksgiving dinner. Alice was remarkably flexible, as she was able to handle the many changes in this Thanksgiving Day schedule while still producing a delicious feast.

Friday, November 27, 1942

Thompson has completed a number of experiments on the carrying of 94 by zirconium phosphate, using 94^{238} as tracer, and on the determination of the separation from fission products. We are beginning to refer to this as the "phosphate method" for separating 94, in view of its promise. He is combining this with a subsequent step in which the zirconium phosphate is dissolved in hydrofluoric acid with the subsequent addition of lanthanum to produce lanthanum fluoride, which carries 94. In order to stimulate extraction plant conditions he makes the zirconium phosphate precipitation from a 20% uranyl nitrate solution. He obtains a yield of about 95% of the 94 together with less than 5% of the fission product gamma activity using neutron-bombarded uranyl nitrate as his source of fission products. In the course of these experiments he has observed that the carrying power of the zirconium phosphate for the 94 is very sensitive to a number of variables and that the 94 phosphate is slowly dissolved out of the mass of the zirconium phosphate on prolonged standing with the mother liquor. This indicates that 94 phosphate may not be isomorphous with zirconium phosphate and might not be carried quantitatively when present in concentrations such as might be produced by a pile (concentrations of 10^{-4} to 10^{-1} as much 94 as added zirconium carrier), suggesting that it will be necessary to test the carrying power of zirconium phosphate for 94

11/27/42

on the ultramicrochemical scale with a concentration of 10^{-2} as much 94 as zirconium.

The American Physical Society is meeting here on the campus today and tomorrow. Although registration is taking place in Eckhart Hall, for lack of space the various sessions are being held in the Pathology and Social Science buildings. Three invited papers and 30 contributed papers are scheduled for the two days. This afternoon at 4:30 in Room 117 of the Pathology Building, Perlman gave the first invited talk, "Applications of Nuclear Physics to the Biological Sciences," which I went to hear. The other two invited papers will be presented tomorrow: "Theory of Random Processes" by G. E. Uhlenbeck of the University of Michigan and "Problems in the Theory of Atmospheric Cosmic-Ray Showers" by Pierre Auger, a former and well-known physics professor at the Sorbonne who made his way to America after the Nazi occupation.

Tonight I went with Perlman to the dinner (\$1.50) at the Quadrangle Club sponsored by the Society and the Physics Club. Auger was the principal speaker; he described the work of the Centre National de la Recherche in France with which he has been closely associated.

The weather turned very cold today, the temperature dropping to 17°F , accompanied by our first substantial snowfall.

Saturday, November 28, 1942

Brown and Hill have conducted a number of experiments to test the stability of the volatile higher fluoride of 94 in order to develop a method of collecting it in a fluoride volatility separation process. Some UF_4 containing 94 tracer was fluorinated at 500°C , and the 94 was collected together with the UF_6 in a trap at dry ice-acetone temperatures. The trap was then allowed to warm up to room temperature (25°C) at which temperature the vapor pressure of UF_6 is appreciable. Dry nitrogen was then slowly passed through the trap and into a water reflux condenser arrangement in which all UF_6 and 94 fluoride entering would be collected.

11/28/42

The residue and the volatilized portions were then analyzed for the 94 present in both the oxidized (fluoride soluble) and reduced (fluoride insoluble) states.

In the first experiment all of the uranium was distilled off, but only 15% of the 94 distilled with it. This was first interpreted as indicating that 94 fluoride had a considerably lower vapor pressure than UF_6 , but observation soon showed that 81% of the 94 collected in the reflux condenser was in the oxidized state, while only 9% of the 94 left behind was oxidized. Since it must be assumed that the reduced 94 found in the reflux condenser was in its upper state when it volatilized with the uranium in the nitrogen stream, it is calculated that only 23% of the total that had been completely oxidized remained in the oxidized state after the removal of the fluorine. It seems quite reasonable to conclude from this that the volatile 94 fluoride is unstable in the absence of fluorine giving as a product the very nonvolatile PuF_4 .

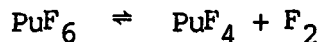

Of the 94 present in the oxidized state, it will be noted that 66% of it volatilized with the uranium, thus indicating that the vapor pressure of the higher fluoride is quite appreciable.

A second experiment was performed in which the UF_6 - PuF_6 mixture was kept away from contact with fluorine for a somewhat shorter period of time. This time 52% of the 94 remained in the oxidized state, of which 33% volatilized in the nitrogen stream together with 40% of the UF_6 .

In the third experiment fluorine was used instead of nitrogen as a sweeping gas. Only 10% of the UF_6 was volatilized from the trip, but this time 35% of the 94 fluoride (oxidized) volatilized with it. This we believe indicates quite strongly that: (1) The higher fluoride of element 94 is unstable in the absence of fluorine. It slowly decomposes to PuF_4 over a period of hours at room temperature. (2) The higher fluoride of element 94 has a vapor pressure at room temperature of the same order of magnitude as UF_6 .

Cunningham and Werner, working with 10^{-2} micromoles of 94^{239} have completed a titration to determine the number of electrons involved in the of $Pu^{(r)}$ to $Pu^{(o)}$ by Ce^{+4} . They find that 1.95×10^{-2} micromoles of Ce^{+4}

11/28/42

is required to oxidize 1.1×10^{-2} micromoles of plutonium, indicating that the oxidation of Pu^{+4} by Ce^{+4} involves the transfer of two electrons.

Allison gave me a copy of a mollifying letter that he has just sent off to Conant in Washington. It reflects the attitude and thinking of those of us who attended the Technical Council meeting last Wednesday, and I endorse it 100 percent. He said the following:

"Dr. Compton has called my attention to your concern over the purity requirements of our final product with respect to inclusion of light elements. I must admit that the list of maximum tolerances is very impressive, and at first glance would seem to be a very formidable obstacle to final success of our project. On closer examination, however, and keeping in mind the progress we have already made in this question of purity, I have come to the conclusion that the requirements represent an exacting problem, but not one which is insoluble.

"There is reason to believe that the chemical nature of our final product is similar to that of uranium, and that the purity we have attained in the manufacture of uranium is an indication of the purity which we can eventually attain in our product. I am indicating in the little table enclosed with this letter the present situation with respect to our uranium production. One should keep in mind that the purity shown in the table is being obtained in regular factory operations involving, in the case of oxide, at least a ton of material a day, and in the case of metal, up to 500 lbs. a day. On the other hand, the fact that beryllium is spectroscopically absent in our product may not mean a great deal, since the sensitivity of the spectroscopic method for beryllium has not been established. I am writing Dr. Rodden, urging him to investigate the sensitivity of methods which can be used to detect beryllium and fluorine especially.

"It seems to me that this table indicates that the purification of our final product to the specifications is an operation which has a high probability of success. Due to the extremely valuable nature of our final material, its purification can be carried out in a specially built laboratory by very highly trained personnel. Magnesium can be substituted for beryllium and chlorine or bromine for fluorine as a contaminant. The most serious difficulty is undoubtedly oxygen, which can be eliminated by

11/28/42

processes such as electrolysis of a molten halide in an atmosphere of helium. For the final purification, the actual neutron emission of our product will have a very sensitive overall test, showing our success in getting the light element contamination down by various chemical operations. Those of us who have considered the matter feel that the requirements, although stringent, can be met."

I also have a copy of a second letter that Allison wrote today, this one to Clement J. Rodden of the National Bureau of Standards in Washington. I will reproduce it here also, as it bears so greatly on our new problem of producing high-purity 94.

"We are looking ahead in our project to the purity requirement of our final material. These requirements are very exacting, but of quite a different nature from those facing us in the production of uranium. Our final product must be free from light elements, and the table which I enclose shows the permissible contamination of it with some of the dangerous substances.

"Dr. Conant was considerably disturbed when this was called to his attention, as he feared that we would never be able to reach the purity required. I have written him a note and sent him a copy of the table which is enclosed in this letter. My general idea is that the table shows that we are reaching a degree of purity in the large-scale output of uranium which indicates that amounts of 50 lbs. or so of our final product can be prepared to the specified purity. I can see, however, that we will probably need the development of further analytical techniques.

"It would be very interesting if we knew the sensitivity of the spectroscopic test for beryllium so that we could get some positive indication of how much beryllium is in our stuff at present. Likewise the fluorine requirement, which as you see, is very low, must be met by some sort of analysis. We would like to find the fluorine content of our metal when it has been produced by reduction of the tetrafluoride.

"The oxygen requirement, we all agree, will be the most difficult to fulfill. This may force us to prepare the metal by electrolysis of a halide in a helium atmosphere, for instance. The carbon requirements will also be bad, and to anticipate some of our difficulties, would it be possible for

11/29/42

you to find out how much carbon there is in a typical sample of the metal as produced in beryllia at Westinghouse. It so happens that the constituent of carbon which will be dangerous to us in the final product is the heavy isotope C^{13} , and this also holds in oxygen, the dangerous constituent being O^{17} . If the situation gets too serious, we may somehow make use of partially separated material provided for us by Dr. Urey in these cases.

"Any comments you have would be very interesting to us. Dr. Seaborg is enlarging his group with a view to tackling this problem intensively. One suggestion has been to reduce the final material to metal by using metallic barium as the reducing agent instead of calcium or magnesium such as we use at present. This procedure would avoid introducing light elements and have another advantage, namely wash out the last traces of radioactive barium present as a fission product in our final material. Have you any suggestions, or a process of making barium of very high purity?"

I received a letter from Vannevar Bush, the Director of OSRD, which appears to be a form letter sent to all of us group leaders. It told of the successful use in combat of new devices developed through the collaboration between the Armed Services and NDRC. He congratulated us who labor to make the American scientific effort thorough, well-rounded, effective and rapid. In a separate paragraph he wrote, "We seem to have reached the turning point of the war, but the end cannot be predicted. We are in a struggle with a resourceful and ruthless enemy. Effort cannot be slackened. The lift that is given by a success of one part of our effort should simply cause us to settle into the collar for the long pull, to cause other efforts to have their effects in due time."

Headlines today say that the full Tunisia offensive is on.

Sunday, November 29, 1942

News in the Sun today tells of the terrible tragedy of a night club fire in Boston. Over four hundred people were killed.

Monday, November 30, 1942

English and Ghiorso have completed their measurements of the slow neutron fission cross section of 94^{239} relative to that of U^{235} using our one-gram Ra-Be neutron source. They made measurements of the fission rate with and without cadmium; so the cross sections correspond to cadmium-absorbable neutrons. Their best results were obtained with a 94^{239} sample weighing 3.1 ± 0.5 micrograms in comparison with the sample of natural uranium weighing 200 micrograms and hence containing 1.4 micrograms of U^{235} . The weight of the 94^{239} was determined by counting its alpha particles with the "low geometry" ionization chamber using calibrated screens interposed between the sample and the collecting electrode and using the value 20,000 years for the half-life of 94^{239} . Their measurements give 5.58 ± 0.036 counts per minute as the slow neutron fission counting rate of the 94^{239} sample and 1.28 ± 0.011 as the (cadmium absorbable) corresponding fission counting rate of the uranium comparison sample. This leads to a ratio of the slow neutron fission rate of 94^{239} to that of U^{235} of

$$\frac{(1.4)(5.58)}{(3.1)(1.28)} = 2.0$$

with a probable error of ± 0.32 . When a better value of the half-life for 94^{239} is obtained, the value of this ratio can be recalculated.

Nearly a year has gone by since I last conducted classes in the Chemistry Department at Berkeley. So it was with an exhilarated feeling that I stood before the Physics 324 class in Ryerson Laboratory this morning to deliver a lecture on atomic and nuclear physics. The topics I touched on were nuclear isomerism, nuclei with unusual radiations, mirror image nuclei, K-electron capture, Auger electrons, x-rays, bremsstrahlung and annihilation radiation, all of a non-secret nature, of course.

Gofman did not receive the patent application case that I wrote to him about a week ago Saturday. So this morning I had to send him a wire and letter explaining that there has been a foul-up: the girl in the main office here who typed up the case mailed it to York in care of E. O. Lawrence in Berkeley, which was according to York's instructions. I

11/30/42

complimented Gofman on his fast neutron measurement work and said I will write it up as soon as possible but that the data were already in use around here the day they arrived, and the fact they haven't been written up yet hasn't subtracted from their usefulness. I asked if Fontana has isolated the U^{234} sample (from the latest large UX_1 sample) and suggested that Gofman check its slow neutron fission cross section as soon as he gets the sample. I closed by saying that this morning I received the Berkeley semi-monthly report and think the people responsible for the extraction work, particularly on the acetate method, have done a wonderful job.

I wrote to Joe Hamilton in Berkeley and told him I have finally located a good uranium metal target for the 20,000 microampere-hour bombardment that I mentioned in my letter to him of November 9. The piece of metal I have is 2 inches by 4 inches and 1/16-inch thick. I said I have learned from Stone that he (Joe) will be here about next weekend and that Helen and I look forward to his having some scrambled eggs with us again.

After midnight tonight, here and in 30 western states, all gasoline must be purchased with ration coupons. According to the Office of Price Administration, there is no gasoline shortage--the mileage rationing procedure has been invoked to save rubber tires. It is assumed that the majority of drivers can get along on four gallons of gasoline per week, sufficient for 150 miles of occupational driving and 90 miles of family driving for one month. I suppose I should be thankful I have no car to add to my worries.

As for the War, today is the 98th day of the siege of Stalingrad. The Soviet armies have killed 15,000 Germans in a new offensive west of Moscow and have crashed through a new German defense line on the east bank of the Don River before Stalingrad in pursuit of the Germans. Also, as printed in the Chicago Tribune for today, information has just been released from London that up to the end of last year, 199,000 bombs have been dropped on Britain killing 43,667 and seriously injuring 50,387.

Churchill made a big speech urging the Italians to overthrow Duce and sue for peace.

DECEMBER, 1942

Tuesday, December 1, 1942

Today Cunningham and Werner began the process of extracting 94 from the aqueous extracts of the ether extractions (performed under Perlman's and Jaffey's direction) of the recent large sample (300 pounds) of UNH bombarded with neutrons at the St. Louis cyclotron (Chicago II, September 5 to October 25, for 100,000 microampere-hours). They began with two two-liter solutions containing about 450 micrograms of 94 together with 3 kilograms of uranium and a high level of fission activity. The combined solutions were diluted to 16 liters using wax-coated four-liter beakers as containers. They made the solution 1 N in HF and 1 N in nitric acid, then added 1,000 mg of La^{+3} in three portions at half-hour intervals. The lanthanum fluoride precipitate was removed by centrifugation and placed in a large platinum dish.

Perlman and I submitted today a supplement for inclusion in our section of "Report on the Feasibility of the '49' Project" of November 26, 1942, entitled "Extraction and Preparation of Final Product". This deals with the possibility of a premature fission chain reaction occurring in the 94 during its isolation from uranium, fission products and other impurities. It is not possible to determine with certainty at present the amount of 94 which will constitute the "critical slow neutron mass." Estimates have been made indicating that as much as 500-1,000 grams may not produce a slow neutron chain reaction even under the optimum conditions of neutron-slowng and the absence of neutron-absorbing materials. If this is so, the anticipated difficulties do not comprise a serious problem, since it will not be unreasonable to limit the amount of 94 isolated at any one time to 1/2 kg. However, the decision as to whether or not 1/2 kg is an optimistic figure will have to await further fission property data that can be obtained on gram amounts of 94^{239} . In the meantime, we will assume that the "critical slow neutron mass" is very small and plan to

12/1/42

have present at any time a sufficient amount of slow neutron-absorbing material to prevent the propagation of a chain reaction.

In our supplementary report Perlman and I consider all the steps in the extraction and decontamination of 94 by the Wet Fluoride Method and the peroxide precipitation method and indicate the precautions that should be taken in order to forestall the possibility of a premature chain reaction. We point out that the dry fluoride volatility method can avoid hydrogen-containing material to a sufficient extent to prevent the slowing down of neutrons as required to produce an efficient chain reaction. We also discuss the final purification and reduction of 94 to the metal from this point of view and indicate that the dry fluoride process, precipitation processes, the ether extraction method of purification and the final reduction to metal are all manageable, provided care is taken to restrict the amounts or, in the case of the precipitation processes, to have neutron-absorbing material present in the reaction vessels.

In the meeting of my group's Research Associates this evening there was a good deal of discussion about the newly identified problem of dealing with the possibility of a fission chain reaction in the chemical extraction plant. There was a consensus that that problem is manageable. Walking home across the Midway after the meeting, Ghiorso and I found the weather turning cold and uncomfortable.

Valda M. Lemke started working with us today as a Laboratory Helper.

Today's headline is "It's Here: Gas Rationing!"

Wednesday, December 2, 1942

During the last few days Brown and Hill have continued experiments to determine the relative volatility of UF_6 and PuF_6 . They fluorinated some UF_4 containing 94^{238} tracer at $500^\circ C$ for an hour and captured the volatile fluorination products in a trap cooled by dry ice-acetone. This mixture of higher fluorides was then allowed to volatilize in a stream of fluorine by heating the trap to about $30^\circ C$. About 60% of the 94 was volatilized

12/2/42

and only 30% of the uranium. In another experiment a temperature of 40°C was used, resulting in the volatilization of about 35% of the 94 and 9% of the uranium. Assuming a perfect solution and using the known vapor pressure of pure UF_6 at these temperatures, Brown calculates that the sublimation point of PuF_6 is in the neighborhood of 32°C, which is to be compared with the sublimation point of UF_6 , namely 56°C. It will be interesting to see whether later work with pure PuF_6 confirms this determination.

The Lewis investigative committee is back in Chicago following their visit to Berkeley, presumably to inform Compton about the fate of the Metallurgical Laboratory. The first committee member I saw today was Greenewalt. We met late this afternoon in the corridor of Eckhart Hall. As he approached me, I could see from his demeanor he was bursting with good news. The aura of cheerfulness and excitement that he carried with him and the way he held out his hand in greeting told me that this signified more than just taking pleasure in seeing me again. Then when I heard him say he had just come from the West Stands, I understood the reason for his jubilation. Fermi has produced a chain reaction—the pile is a success! Greenewalt said that Fermi, Whitaker, Zinn and their crew started the experiment this morning. As the control rods were cautiously withdrawn throughout the day a few inches at a time, Fermi would take the new meter readings, and using his slide rule, would calculate the multiplication factor. Greenewalt said that he and Compton stood on the balcony, alongside Fermi and most of his crew, watching the proceedings. Then at 3:20 p.m., Fermi called for a few more centimeters. The pile became self-sustaining; in a few minutes the output of the chain reaction rose to one watt. Fermi ordered the reaction stopped, and everyone was tremendously relieved to see that the activity could be extinguished by shoving the rods back into place. The reaction took place without requiring as much material as Fermi earlier anticipated (and thus he was two weeks ahead of schedule), and it was not necessary to use the balloon to exclude air from the pile. However, he did use almost six tons of uranium metal, 50 tons of uranium oxide, and 400 tons of graphite, nearly as much as predicted. (I learned later that Zinn, Anderson and their pile builders reached a point where they knew the pile would be self-sustaining very early this

12/2/42

morning but did not proceed to this historic point, leaving this dramatic act for a more convenient time later in the day.)

Of course we have no way of knowing if this is the first time a sustained chain reaction has been achieved. The Germans may have beaten us to it. I wonder, are they aware that U^{233} can be made from Th^{232} and 94^{239} from U^{238} in a chain-reacting pile and that either of these isotopes can be used in a fission bomb? And if they have a pile that chain-reacts, would they use it to generate power or to produce vast amounts of radioactivity as a military weapon? One thing is certain; although Fermi has demonstrated that we now have a means of manufacturing 94^{239} in copious amounts, it is the responsibility of chemists to show that the 94 can be extracted and purified to the degree required for a working bomb.

Hamilton wrote a short letter, which I received today, saying that if all goes well he intends to come to Chicago next Monday and stay for a week. He wants to give Kenneth S. Cole a hand with the animals used in radiological experiments and wishes to ask Perlman and me a number of questions about some of the chemical separations on fission products that he and others are doing in Berkeley. He said that John Lawrence is most anxious to secure a copy of the isotope chart, like the one I recently sent him, along with one of my isotope tables. "He has a large group of people working for him over in Donner now," he went on, "and they really do need some beacon light to lead them to the truth."

Latimer wired that he is flying East tonight and hopes to see me tomorrow. Kirk wired also from Berkeley. He is unable to obtain space on the streamliner and so will fly, arriving here next Monday at 3:15 p.m. Fortunately, we were able to install the heavy supporting slabs in the new chemistry building last Monday in preparation for the new ultramicrobalance that Kirk will bring with him.

It has been snowing the last few days with the temperature hovering in the neighborhood of 20° to 30° F, but today the temperature dropped to 0° F.

Thursday, December 3, 1942

Perlman attended the meeting of the Chemistry Division Group Leaders held in Room 209, Eckhart Hall, from 9:15-10:30 a.m. this morning, along with Allison, Boyd, Burton, Coryell, Cunningham, Franck, Howe, Johns, Neubert, Smith and Spedding. Coryell reported on the role of accumulated fission products as neutron poisons in a chain-reacting pile and summarized further information on the yields and radiation properties of the longer lived fission products; he related this information to the amount of shielding and remote control operation required for the separation processes for 94. Perlman made a comparison of the specificity of carrying of $94^{(r)}$ by various carriers as related to the carrying or non-carrying of fission products in each case. Johns summarized the work in the Ames Laboratory on fission products and the chemistry of 93 and 94.

Kirk sent another telegram today. He asked me to get him an official travel authorization so that he won't be "bumped" from the plane when he travels next Monday.

I wrote a memorandum to Compton, explaining the reluctance of Paramount Pictures, Inc., to release Baumbach for a position here as Research Assistant, and asked if he himself would write to the studio and ask them to grant him a leave of absence. I concluded by saying, "Mr. Baumbach is a very able chemist and is particularly equipped with the sort of aptitude and ability which will make him very useful in the purification of 49 development work."

The regular meeting of the Technical Council was held today, following closely on the heels of the sustained chain reaction that took place yesterday. Again I was invited to attend because of special concern about the possibility of plutonium chain reactions in the chemical extraction plant. Those in attendance were Allison, Fermi, Howe, Manley, Moore, Spedding, Wheeler, Wigner and I. Nothing much was said during the early part of the meeting about the successful chain reaction yesterday, although the import of it was on all our minds. The first business on the agenda was to discuss the acquisition of some mesothorium (Ra^{228} , a decay

12/3/42

product of the long-lived Th^{232}), from which a decay product, radiothorium (Th^{228}) can be extracted. Manley is interested in the radiothorium because it is ideal as a fast neutron standard; the neutrons are produced from the γ, n reaction on Be^9 . Allison said that one curie of mesothorium at \$27 per millicurie is available, and Manley thought 90 millicuries might suffice, to which Wigner moved that 100 millicuries be purchased. Before a vote could be taken, I proposed that we obtain the whole curie, because its availability would be a tremendous advantage to Kennedy and Segrè who are making cross section measurements and calibration standards. Manley agreed, saying that experiments would be speeded up, thus saving time and money equivalent to the source cost. Wigner then changed his motion to refer to one curie, to which there was general agreement.

The next topic we embraced concerned plutonium solutions, of grave concern to me and the chemical engineers. Here I quote from the minutes of the meeting:

Allison: Last Thursday we experienced a set-back when it became apparent that the 94 content of solutions in an extraction plant might cause a chain reaction.

Wigner: One kilogram of 94^{239} dissolved in 40 liters of water is, according to Christy, the smallest amount that could chain-react. Owing to the possible presence of reflections, 1/8 kilogram of 94 could be dangerous.

Seaborg: Neodymium fraction of rare earths from Lindsay Light at \$15 per pound might be used to prevent a chain reaction. The advantage of rare earths is that they go along with the 94 in chemical separations.

Fermi: The difficulty that cross sections of rare earths go down faster than the $1/v$ cross section of 94 is easy to overcome by adding an excess of these rare earths.

Manley: It is impossible to say whether one ton of metallic uranium enriched by 94 would produce a fast neutron reaction.

Fermi: It is doubtful.

Wigner: I'm not at all sure that a ton is safe.

Fermi: All estimates made at present must be considered as guesses. I will organize experiments to measure absorption by the mixture of rare earths under discussion.

12/3/42

The problem of cavitation in liquid-cooled piles next occupied the attention of the Council. When that was dismissed, Fermi referred to the chain reaction of yesterday. He said that the energy released was between one-half and one watt. In the half-hour of operation, he and others were exposed to a dose of about 20 percent of the daily maximum. It will now be necessary to move the pile to Argonne to achieve a higher power level. He said the work yesterday indicates the possibility of measuring changes in the multiplication constant k of the order of 10^{-5} . After a brief discussion with Allison and Wigner about the lattice structure and possible experiments, Fermi concluded the meeting by telling us that the period of exponential rise of yesterday's neutron intensity as the controls were removed was 270 seconds, corresponding to $k = 1.006$. If left uncontrolled for 1-1/2 hours, the pile would have reached a power of 10^6 kw.

Friday, December 4, 1942

I saw Latimer today, and we reviewed the problem of just how much 94 can be handled safely during the extraction and purification procedure, without causing a premature chain reaction, as well as the many aspects of our research programs.

The Technical Council met for the second time this week. At this meeting, Compton was present, as were Henry W. Newson, a Research Associate in physics, Waverly Q. Smith of du Pont, Allison, Fermi, Hilberry, Moore, Stearns, Wheeler, Whitaker, Wigner and I. Even before the meeting started, all of us were aware that the Lewis reviewing committee has given its unqualified approval of the continuance of the Metallurgical Laboratory and that we should proceed with pilot plant tests for practical experience; in fact, this was the substance of its final report that was prepared before the committee returned to Chicago on Wednesday and before they were sure Fermi would achieve a chain reaction.

Compton opened the meeting by telling us how Conant reacted to the news about the pile. After he and Greenewalt came down off the balcony and returned to his office, he got James Conant on the phone and said, "Jim, you will be interested to know that Columbus has just landed in the

12/4/42

New World. The Italian Navigator over-estimated the size of the Earth and so arrived sooner than he had expected."

Conant's excited voice came back, "Is that so! Were the natives friendly?"

"Everyone landed safe and happy," Compton replied.

Those of us who stole glances at Fermi saw that he was sitting there quietly, enjoying every minute of Compton's story. We all laughed. The story helped break up the tension that had been mounting ever since we learned that the future of the Lab was at stake and that the committee's decision might depend on how well we wrote up the feasibility report.

Stearns announced that the new pile building at Argonne Forest will be ready for occupancy on the 15th of this month. Compton said that engineering experiments could be performed there if we install a production pile but that intermediate experiments could take place in the West Stands. By moving Pile I to the Argonne building and surrounding it with appropriate shielding, Fermi predicted that he could get an output of 100 milligrams of 94 per day. He said he could even produce 10 times this much from the point of view of cooling feasibility, but then it would be difficult to dismantle the pile to extract the 94. Compton thought that the material could be removed even after the production of 10 grams; he said the lumps of uranium could be pushed out from the interior. Smith and I said that we would be set up to treat 1/4 ton of uranium per day. I reminded the group that we are successfully removing close to five milligrams of 94 per ton of the St. Louis UNH material on a routine basis. Since this is a convenient ratio of 94 to uranium, why not let the pile produce large amounts at this concentration? The Lewis committee, according to Compton, asked how much 94 we need for experiments. Fermi replied that one gram would be sufficient for several neutron experiments.

Whitaker and Newson ventured to say that Pile II as presently designed would not be adaptable for quick construction at the Argonne Forest site, and it was suggested that it would be quicker to produce 94 by first building a simpler pile there. A schedule for such a pile was offered: February 1, construction starts; February 28, last graphite in place; March 15, through laying-up pile, operate to April 15; start dismantling in May; finish June 1. Start construction of Pile II around July 1. It was pointed out by Compton that the simpler pile at Argonne

12/4/42

would not be like the one here in the West Stands now but would be redesigned and improved. He suggested that construction start as early as January 15, because by that date Fermi would be through with a series of experiments he is about to undertake. Compton said that Cooper suggests construction of a shack for chemical separation work at Argonne.

The war front headlined today is the Pacific. The Japanese lost nine ships, at a cost of a cruiser to the United States. The United States was successful, however, in repulsing the Japanese on this round of the Battle of Guadalcanal.

Saturday, December 5, 1942

There are several matters I want to take up with Wahl; so today I sent him the following letter. I believe it gives a fair summary of the present state of 94 chemistry here:

"I was certainly pleased to see the fine work on extraction processes which came out in your last semi-monthly report. You certainly took me seriously when I said that there was need for further immediate work on extraction. The quantitative work, tracer and microchemical, that you fellows do, rather shows up the more qualitative work done here at Chicago. The report has been a little late in coming out, largely due to that mass of tables you included; when my secretary saw those tables I wasn't sure that she wasn't going to quit (not really).

"In regard to putting the 'acetate' extraction process, or any other extraction process which might develop, into engineering practice, I might go over with you the general program on which the design engineers at Wilmington (there are about fifty of them) are operating. It has been decided that the design division will design and have built three broad general types of extraction equipment:

1. Equipment for carrying out dry gaseous reactions (fluorine, hydrogen fluoride, chlorine, etc.) (Process 1)
2. Equipment to handle large precipitates (sodium uranyl acetate, peroxide, etc.) (Process 2)

12/5/42

3. Equipment to handle small precipitates (wet fluoride, phosphate, iodate, etc.) (Process 3)

This means that three different methods will be used and tested on the first actual extraction of pile material. It was considered by these engineers, of whom there are not better, that it would be much safer to carry out such a general program than to rely upon any one method, and perhaps have to make a complete switch (due to unforeseeable reasons) at the last moment. They will attempt to design equipment for these three general processes that will stand the worst possible conditions (i.e., so that it will handle the material from the highest energy pile) so that if new methods are found which make operating conditions less stringent, the apparatus can still be used, and the only loss will be some of the design engineers' time.

"The design division is working on the above-numbered processes in the following order—first, process (3), then process (1), and then process (2). This order was somewhat arbitrarily chosen a couple of months ago, but, of course, the processes are being worked on to some extent in parallel as well as consecutively. In any case, design and building of equipment for all three processes will be completed before any extraction work begins. This means that there will probably be available for process (2) the most time for engineering development work (i.e., laboratory work by chemical engineers here); it is my guess that the sodium-uranyl-acetate method will be the one that is put into operation for process (2) for the first actual extraction, but this will depend somewhat upon what the development engineers here find out in their work on it. The December 1 'freezing' date that I spoke to you about when you were here referred to process (3), and incidentally this deadline has not been met. The idea was to freeze some design for the wet fluoride method which would then handle any easier method which came up (such as the phosphate or iodate method), but the removal of the fluoride precipitate has presented such obstacles that it may be necessary to jump directly to a phosphate or iodate method for process (3).

"As Professor Latimer has undoubtedly told you, attention has been focused here on the purification problem. You will probably remember that I discussed this with you when you were here last month, and in the meantime, I have raised the issue with the higher authorities and got the

12/5/42

matter definitized. It turns out that, in order to sufficiently eliminate the neutrons that might be formed by the α, n reaction in light impurities, the final product must contain no more than the following amounts of impurities (parts per million):

Be	0.1	Na	20
Li	0.5	Mg	100
B	0.2	Al	20
C	20	Si	200
O	100	P	100
N	(no α, n restriction)	Cl	1,000
F	5	Ca	10,000

and so on up to Cu, upon which there are practically no restrictions.

"I believe that these purity requirements can be met, but it will be a rather difficult job and will mean that from now on we must focus more attention than we had only casually planned before. I'll be glad to hear of any ideas that you, Connick, Garner, Gofman, etc., have on this problem. This information on the purity requirements, which, of course, all of us who are working on the chemistry of 94 must of necessity eventually know, comes in the class of 'limited' information because it involves consideration of the use of the final product. Therefore, I would be extremely cautious about discussing it with any others than those you think it to be absolutely necessary. At present we are going through the process of arriving at a definite program to handle this problem, and, in the meantime, probably the less said about it the better.

"Another problem which is just now rearing its head, and which perhaps must be handled with even a greater degree of secrecy at this stage, is the problem of just how much material it is safe to handle during the extraction and purification procedure, in order that a premature chain reaction does not occur. This includes the question of the maximum concentration and absolute amounts of 49 which may be present in the various solutions and precipitates. I discussed this problem with Latimer when he was here yesterday, and he will probably be able to tell you more about it when he returns to Berkeley. I'll write you more on this point later.

12/5/42

"You may find it convenient to have some of the men there read this letter--e.g., Connick, Garner, Gofman.

"My best regards to you and the rest of the fellows."

War news from the African front is depressing. The Axis has been on the attack and made some gains; the Allies seem to be stalled in Tunisia.

Sunday, December 6, 1942

The Chicago Sun reports today that the President has ordered the halting of all voluntary enlistments and the drafting and enlisting of all men over the age of 37.

Monday, December 7, 1942

Today Perlman, Brown and I sent a letter to Charles Cooper, describing in some detail the status of various methods for the extraction and decontamination of 94 with emphasis on the weights of precipitates and other 94 fractions, the amounts of fission activity that are present at each step and its heating effect. We describe various combinations of wet and dry methods as follows: Process I-- Extraction by simplified wet fluoride method, decontamination by dry fluoride method; Process Ia-- Extraction by complete wet fluoride method, decontamination by dry fluoride method; Process II--Extraction by simplified phosphate method and decontamination by the dry fluoride method; Process IIa--Extraction by complete phosphate method, decontamination by dry fluoride method; Process III--Extraction by a dry fluoride method, decontamination by dry fluoride method; Process IV--Decontamination by wet fluoride method after extraction by Processes I, II, III. We also mention the new zirconium phosphate method for separating 94 and describe the conditions for the precipitation of zirconium phosphate, its dissolution in HF followed by precipitation of lanthanum fluoride.

12/7/42

Hamilton arrived from Berkeley as anticipated. He will spend a week here discussing with Ken Cole, Perlman, me and others the role of 94 and the problems of fission products as health hazards and research programs for determining their ingestion and retention in animals.

I decided to do some recruiting for my group today and wrote three letters. Kohman has recommended that we hire his friend, Theodore J. La Chapelle, who will finish his undergraduate work about February 1 at the University of Wisconsin, and so I wrote to Professor Norris F. Hall of the Department of Chemistry there, asking him for his opinion of La Chapelle and to suggest others that he would recommend. My second letter went to my friend Henry Taube at Cornell University. Taube was a graduate student at Berkeley whom I knew well; he got his doctorate in chemistry in 1940. I told him we are in need of some very good inorganic chemists and asked if he could get a leave of absence from the department through Professor Debye. Remembering that he is of Canadian origin, I asked if he has obtained his final citizenship papers yet. My final letter was addressed to Saul Winstein in the Department of Chemistry, UCLA. I told him how great my need is at present to add more bachelors or masters men in chemistry to my group and asked if he could suggest some very good individuals in these categories. "Winter has really come to Chicago," I wrote, "there being several days last week when the average temperature was about zero, and the whole place is now covered with a blanket of snow. It hardly seems to me as though I have been here eight months. Helen and I don't mind the snow or cold very much; in fact we are rather enjoying it."

Our "Report for November 16-30, 1942, Chemistry of 94, University of California and University of Chicago Groups" (No. CN-363) is finally ready. It was delayed because of the time it took Miss Smith to prepare the complicated diagrams and tables for the Berkeley part; preparation of these reports is a duty she has to fit into her already busy schedule. We are going to have to get some help for her.

In the report Thompson describes his work on the phosphate method of separating 94 by precipitating with zirconium phosphate as the carrier from acid solution, followed by dissolution in hydrofluoric acid and precipitation of lanthanum fluoride, the latter step being used to

12/7/42

eliminate the zirconium and columbium fission products which come down with the zirconium phosphate. Yields of more than 90% are obtained, but there is some evidence that plutonium phosphate may redissolve upon long standing in contact with the nitric acid solution of phosphate and uranium.

The Report says that Brown and Hill have studied methods for collecting the higher fluoride of 94 once it is formed in the fluoride volatility process. Tests indicate (a) the vapor pressure of 94 fluoride is about the same at room temperature as that of UF_6 and (b) the 94 upper fluoride is unstable in the absence of fluorine, decomposing slowly to PuF_4 . In view of these findings it is now visualized that 94 can be isolated from the uranium by volatilizing both the uranium and 94 simultaneously and collecting the 94-uranium mixture together in a cold trap, following which the mixture could be heated and the UF_6 vaporized leaving the pure 94 behind in its reduced state. An alternate procedure would be to pass the 94-uranium fluoride mixture over a mild reducing agent which would remove all traces of fluorine, allowing the 94 fluoride to decompose and deposit while the UF_6 passes on through.

The Report continues with summaries of the activities of others in my group. Magel has studied the volatility of 94 metal by using bombarded uranium metal and has found that 94 is 90 times more volatile than uranium metal at $2,000^\circ C$; the vapor pressure of 94 is calculated to be about 10 mm Hg. Cunningham and Werner, using ultramicrochemical techniques, have measured the oxidation number of 94 by titration of the lower oxidation state with Ce(IV) and find evidence that the oxidation involves a transfer of two electrons. However, no great accuracy is claimed as in a blank experiment a comparable amount of Ce(IV) was consumed. Kohman has conducted experiments showing that 93 and 94 fluorides are soluble in ammonium fluoride solution and that they might be separated from rare earths by use of this property. The Report goes on to say that Perlman and Knox have continued their studies of ways of reducing the amount of gamma-activity remaining with 94 after the initial separation from uranium in the Wet Fluoride Process. They find that young fission product mixtures do not permit such good separation from gamma activity as old fission mixtures; their experiments suggest that 12-day barium should first be removed by a joint fluoride-sulfate precipitation before the initial separation of plutonium from uranium.

12/7/42

In the Berkeley part of the Report, Connick, Gofman and Wahl report on "The Sodium Uranyl Acetate Method for Separation of Plutonium." This is an exciting and promising new method in which 94 in oxidized form is coprecipitated with sodium uranyl acetate and then, after dissolution and reduction of the 94, the uranium is separated from the 94 by a second precipitation of sodium uranyl acetate. This cycle may be repeated and the fission products are separated from the 94 by this application of the oxidation-reduction principle. Using the sample of St. Louis neutron-irradiated UNH we sent them, together with added 94^{238} tracer, they have run through a cycle and a half and find a yield for plutonium of 95% accompanied by only 0.04% of the fission product beta particle radioactivity. They also ran through one cycle of the process on the microscale, using one microgram of 94^{239} , at the ratio of 94^{239} to uranium that will be found after operation of a 10^5 kw pile; they found the same high yield of plutonium that they found on the tracer scale.

Also included in the Berkeley part of our Report is a section by Duffield, Fontana, Garner, Sheline and Stoughton on "Iodate Method for Separation of 94." In this method thorium iodate is used as a carrier for 94 in an oxidation reduction cycle with good results. Finally there is a section by Hamaker on "The Wet Fluoride Method. Use of H_2O_2 as a Reducing Agent for 94."

Just one year ago today Japanese carrier planes attacked our U.S. Naval base at Pearl Harbor and nearby Army bases and bombed our Pacific Fleet. American casualties amounted to 2,280 killed and over 1,000 wounded. Japan struck British possessions in the Pacific without warning also. The next day the U.S. and Great Britain declared war on Japan, and only four days later, on December 11, Germany and Italy declared war on the U.S., to which we replied with declarations against them. It is astonishing how much ground our scientists and engineers have covered since then in developing ways to produce fissionable materials for atomic weapons.

Tuesday, December 8, 1942

Brown and Hill have carried out another experiment to determine the stability of PuF_6 using a mixture of UF_6 and PuF_6 (tracer quantities). The mixture was heated under a nitrogen atmosphere at about 100°C . Then about half of the UF_6 was volatilized in the nitrogen stream at 31°C and captured in a cold trap which was found to include essentially no 94 (approximately 1%). Thus it is clear that the higher fluoride of 94 is easily reduced by heat in the absence of fluorine.

Willard has been working on the disposal problem—that is, putting the solution of uranium and fission products remaining after the 94 has been removed by co-precipitation with lanthanum fluoride into a form which can be stored or disposed. He finds that if he adds to a solution of neutron-bombarded 10% UNH, from which the lanthanum fluoride containing 94 has been precipitated, a sufficient amount of NaOH or NH_4OH or calcium carbonate to make the solution alkaline, most of the uranium precipitates, leaving only a few percent of the fission product gamma ray activity in the supernatant. In such a waste disposal procedure the supernatant could then be concentrated to a small volume by evaporation. This has the advantage that it would be possible to dispose of all the waste liquor by storing it in one tank after precipitation followed by evaporation of the supernatant to produce a total volume of less than 20% of the original solution volume.

John R. Ruhoff, who is now on General Groves' staff, sent me a letter of introduction to Captain P. L. Merritt, who is in charge of procurement of ore and other raw materials. He said: "Since I know that you have given considerable study to the procurement of ore, I would appreciate it if you would discuss with Captain Merritt the information which you have available and give him any suggestions you may feel free to offer."

Merritt, like Ruhoff, is attached to the unit of the War Department's Engineer Office in New York City called the Manhattan District. The whole scientific and engineering effort associated with the development of the atomic bomb, which is concentrated at the University of California in Berkeley, The University of Chicago and Columbia University, but also

12/8/42

scattered in dozens of smaller laboratories throughout the U.S, is coming to be known as the "Manhattan Project."

In our group meeting this evening there was a focus on our increasing collaboration with Charles Cooper's chemical engineers and on the chemical extraction processes that we have identified for him.

Newspapers report that a big tank battle is raging for vital hills in Tunisia.

Wednesday, December 9, 1942

During the last several days Brown and Hill have volatilized zirconium as the fluoride by hydrofluorination at 700°C of a sample of zirconium phosphate which was precipitated carrying tracer 94. They find that the 94 remains in the residue and is not volatilized along with the ZrF_4 under these conditions.

After several delays, Paul L. Kirk arrived at the Lab from Berkeley, bringing with him the precious ultramicrobalance that he, with the assistance of Roderick Craig and Jonas E. Gullberg, has been developing the last several months. Now he and the other ultramicro-chemists will set it up in the new chemistry building. Covey is not here to help; his mother died unexpectedly last Friday and he went to Oakland, California, for a week's leave of absence. As soon as Kirk feels that Cefola, Cunningham and Werner are proficient in the use of the balance, he will return to Berkeley.

The balance mechanism is mounted on a thick baseplate which, with its housing, occupies a space a little short of three feet long, one foot wide and about 16 inches high. It operates by producing a torsion in a quartz fiber, rather than a deflection of a quartz fiber as in the Salvioni balance. The quartz torsion fiber is horizontal and is stretched between a quartz bow and a vernier dial. The beam of the balance, also horizontal, consists of a quartz fiber structure and is attached at right angles to the torsion fiber; hanging from either end is a weighing pan made of

12/9/42

platinum foil. When material is placed in one of the pans to be weighed, the beam is rotated through a small angle, thus twisting the fiber holding it. The torque applied at the vernier dial to restore the beam to its horizontal position gives a measure of weight in the pan. Unlike the Salvioni balance that has a weighing range of about 20 micrograms and a load capacity of 0.3 milligram, the new balance has a weighing range of 300 micrograms and a load capacity of more than 10 milligrams, yet has the same sensitivity of 0.02 microgram. See Figure 25.

I wrote to Stoughton complimenting him and Fontana on the excellent work with U^{233} , as evidenced by a report they recently sent me. I said that the information office may decide to issue all U^{233} reports in a special category. It was Stoughton, along with Gofman and me, who demonstrated the fissionability of U^{233} last February 2, almost a year ago. I informed Stoughton, "I have made considerable progress within the last few weeks in selling the authorities here on the idea of producing and using U^{233} as an alternative to the use of 94^{239} and U^{235} . The advantages are becoming more and more apparent to those who make the decisions, and I think that there is no doubt that thorium will be placed around some of the operating piles. For example, there will probably be placed about a ton or two of thorium near pile number two (i.e., the approximately 10^3 kw pile) in order to further test the usefulness of U^{233} ."

In my letter I said that there are a number of factors in the production and use of U^{233} that I did not bring out in my report CF-268, "Proposal for the Production and Use of U^{233} ," issued last September 18, and that I intend to write a supplementary report bringing out these facts as soon as I find time. I told him that Brown had done some more work on the extraction of U^{233} using hydrogen fluoride and fluorine, and perhaps we can soon issue all our reports together. "I should like to keep in close touch with your work on U^{233} ," I continued, "and I will try from now on to keep you more closely informed on the progress which I make in actually arranging for the manufacture and use of this material. As you know, the use of U^{233} is a rather new idea (although it shouldn't be) to a number of the people who are running things, who are all wound up in their considerations about the use of 94^{239} and U^{235} ."

12/9/42

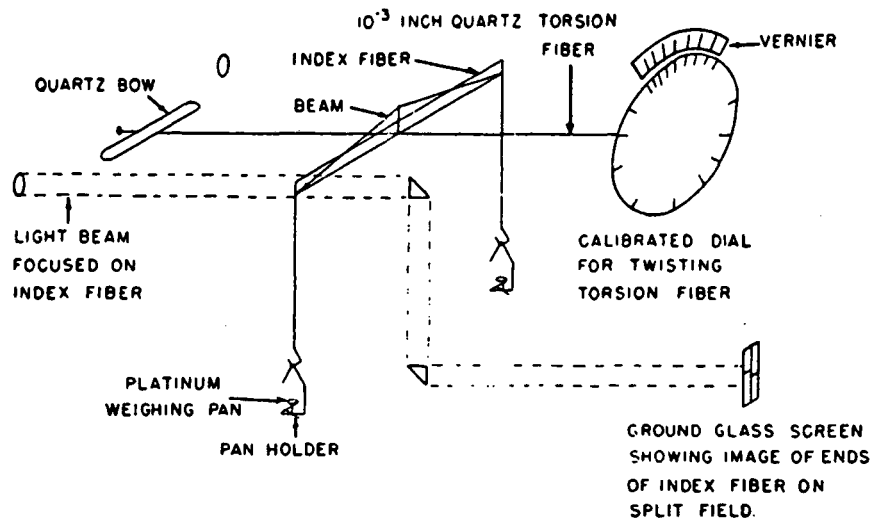

Fig. 25 Quartz Fiber Torsion Microbalance. Schematic diagram.
(MU 13764)

12/9/42

In conclusion I said that I was happy to see the work "that you are doing on the development of an iodate method for the extraction of 94. As you have seen in the reports, some of the fellows here have been working on a phosphate method. The engineers like a method of this type (phosphate or iodate) because of its potential simplicity. Of course, in either the phosphate or iodate method there exists the possibility of using thorium or hafnium or zirconium, or perhaps even uranous uranium as a carrier."

Gofman phoned from Berkeley to ask if we can spare some more of the UNH from the last St. Louis bombardment. I responded that we have very little left but I will check and let him know how much is available.

The battle in Tunisia (at Tebourba) is raging for the third day; an allied counter blow, however, seems to be throwing the Nazis back.

Thursday, December 10, 1942

In view of the apparent potential of Thompson's phosphate method for separating 94, I asked James and Koshland to join him in this work. They have completed a rather thorough investigation of the conditions under which 94 is co-precipitated with zirconium phosphate and separated from the fission products when the zirconium phosphate is followed by a lanthanum fluoride precipitation step. Starting with 20% uranyl nitrate solutions, they have found the best yields when the nitric acid concentration is about 0.5 M, but this has the disadvantage that more fission activity appears with the 94 in the lanthanum fluoride precipitate than when a higher acidity is used in the initial zirconium phosphate precipitation. Low acidities also result in the slow precipitation of uranyl phosphate. They also find that 94 is efficiently carried on preformed precipitates of zirconium phosphate, that is, precipitates formed by the addition of zirconium carrier to the phosphate solution. They find that they may need as much as 3 mg of zirconium per 10 cc of solution to get high carrying of 94 and that precipitation temperatures of about 50°C are optimal with respect to 94 yield and rate of precipitate formation. The

12/10/42

phosphoric acid concentration is found to be rather critical with a maximum 94 yield obtained at concentrations of 0.3-0.4 M. The presence of lanthanum holdback carrier in the zirconium phosphate precipitation step seems to have little effect.

Today Willard tested the sodium uranyl acetate method for separating 94 from fission products and uranium. This method is being developed at Berkeley, and Willard wants to check the Berkeley results. In this method 94 in the oxidized state is precipitated along with all of the uranium which is precipitated as sodium uranyl acetate; then the sodium uranyl acetate is dissolved, the 94 reduced and the sodium uranyl acetate reprecipitated, leaving the 94 in solution. It has been found at Berkeley, using microtechniques, that 96% of the 94 and only 1% of the uranium, 1.5% of the fission product beta radiation and 3.5% of the fission product gamma radiation remains in solution at this point. Willard ran through such a cycle on the tracer scale and finds in the final solution 94% of the 94, 4.3% of the fission product beta particle activity and about 12.0% of the fission product gamma-ray activity. The difference between Willard's and the Berkeley results may be due to the fact that his neutron-bombarded UNH, which he used as starting material, has a higher proportion of fission product zirconium in it.

I wrote to Gofman and said that we can provide him with no more than a half or one pound of neutron-bombarded UNH. I also informed him that the present bombardment at St. Louis will probably reach the 100,000 microampere hour mark in about two more weeks, and at that time we will be able to send him as much of it as he wishes.

The weekly meeting of the Technical Council was held today, which I attended along with Allison, Cooper, Creutz, Fermi, Hilberry, Manley, Moore, Newson, Spedding, Stearns, Stone, Wheeler, Whitaker and Wigner. Joe Hamilton came as a guest. Creutz opened the meeting by describing extrusion tests on uranium metal at the Wolverine Tube Company of Detroit. When the question came up as to the schedule for uranium metal production for 1943, Hilberry said that two tons will be produced daily, with a possible total output of 86 tons monthly from all sources. Fermi

12/10/42

commented that it is his impression 70 tons will be required for the helium-cooled 94 production plant, if of a spherical shape.

Our discussion turned to the subject of mesothorium. Allison said he has talked to Boris Pregel of the Canadian Uranium and Radium Corporation that owns the one-curie supply of mesothorium we agreed to buy last Thursday. Pregel's source was originally made for the British and the mesothorium is packed in 29 glass needles, some filled recently and others a year ago. There was concern about the relative amounts of mesothorium and radiothorium in the needles, and we agreed to buy one of the seeds (needles) in order to subject the gas to analysis. I remarked that only 10 microcuries would be necessary to chemically separate the radiothorium. Allison also learned that Lindsay Light Company in West Chicago is making mesothorium at the rate of 100 millicuries per month but their process separates out the radiothorium in a way that makes it unavailable. They used to sell mesothorium for \$24 per millicurie but recently the bottom fell out of the market; Pregel, however, is holding out for \$27 per millicurie, the reason not being evident.

We next talked about neutron temperature experiments and where they should be performed. Cyclotrons at Bloomington, Indiana; Princeton; Chicago; Ohio State; Purdue; Ann Arbor and Rochester, New York, were considered. No decision was made.

We concluded the meeting by discussing radiological safety and our immediate needs for 94^{239} . Allison said that the purpose of the Argonne Forest pile is to make enough 94 for Cooper and me. Cooper then made some estimates of the amounts of materials to be handled at Argonne to extract up to 15 grams of 94. Starting with 10 tons of uranium metal from the pile center, 20,000 gallons of solution would have to be handled and disposed of. A simple operation would be followed, carrying down the production in one precipitate in each batch. Considerable equipment would be necessary to perform an extraction on 10 tons in thirty days, such as a stainless steel tank in a pit 8' x 8' x 20' deep; a waste disposal tank 20' x 20' x 10' high, buried under dirt; and a shack 15' x 30' in which to perform the chemical operations.

This large operation seemed to disturb Allison because he quoted Whitaker as saying that 0.1 gram of 94 per month would be practical to handle with reasonably simple machinery. Fermi thought it would be

reasonably simple to process one gram per month. I then went to the blackboard and wrote out a table of the amounts of 94 needed versus the experimental objectives. It was as follows (with "desirability" on a relative scale):

<u>Amount of 94</u>	<u>Desirability for Chemistry</u>	<u>Desirability for Physics</u>
10 gm	100 (purity determination)	
1 gm		75 (neutrons/fission)
0.1 gm	40 (metallurgy)	
0.05 gm	30 (metal density)	
St. Louis alone	1	

Fermi declared that there is no need for as much as 10 grams per month and Hilberry added that Compton is in Washington proposing that 0.1 gram per month is the minimum amount that should be considered.

When Cooper and Whitaker suggested that the pile should be composed of all uranium metal and no oxide, Allison asked why. It was Cooper's opinion that the oxide pellets might fracture and release radioactive dust. Wigner suggested canning the oxide. Cooper suggested that UO_2 might oxidize to U_3O_8 and swell so perhaps it might be better to use the latter in the first place. Hilberry commented that oxide is now about \$5 per pound, whereas the metal is \$15 in large batches. Cooper then said that the only reason for not using all metal in the new pile is the possibility of holding up other programs. Hilberry said that we can expect 45 tons of uranium metal by March 15. Fermi suggested we might economize by using large lumps of metal at the pile center and smaller ones toward the outside. The question of radiological safety arose, Stone saying that metal is preferred to oxide, and Hamilton spoke up, with the comment that the physiological distribution of fission products coming from one lump of metal is worthwhile knowing—we need about 100 millicuries of radioactive fission products prepared from such a lump in order to make this determination. Stone added that Hamilton's work shows that some of these products are absorbed from the lungs by the blood and are deposited in the bones.

12/10/42

This conversation led Allison to inquire who has responsibility for the shielding of the Argonne pile, and Hilberry and Whitaker replied in unison, "Newson." For one-gram production per month, Newson said, it would not be difficult to shield for neutrons if one is going to shield for gamma rays anyway. Fermi agreed and estimated that the number of neutrons would be only about five times that coming from a big cyclotron. Research Associates who were suggested for making shielding calculations were Alvin M. Weinberg, Francis L. Friedman and Lyle B. Borst.

Seeing that the meeting was about to end, Fermi pressed for agreement on the 94 production rate of one gram per month. There seemed to be no objection. Cooper suggested that the extraction equipment must be ordered very soon to be ready on time, and I volunteered to prepare a report for Hilberry emphasizing the importance of 94 production. This I plan to do immediately.

Allison suggested the following organization for Argonne: Fermi, Director; Cooper, Seaborg responsible for Chemistry; Whitaker, Newson, Stearns responsible for Physics; Cantril responsible for Health.

Friday, December 11, 1942

Cunningham and Werner have completed the isolation of the 94^{239} from the aqueous concentrate of the ether extraction of the large sample of neutron-bombarded UNH (Chicago II) which they began on December 1. They have gone through a number of oxidation-reduction cycles using $S_2O_8^{-2} + Ag^{+2}$ as oxidizing agent and H_2O_2 as reducing agent. They concentrated the 94 by using diminishing amounts of lanthanum fluoride carrier in each step until finally today they have eliminated the carrier and come up with a final solution of 230 micrograms of plutonium as the nitrate in 100 λ volume. In the course of this isolation procedure they have produced sufficiently large pure precipitates of plutonous hydroxide and plutonous fluoride to view their colors by reflected light; earlier views of thin layers have been largely by transmitted light. They find plutonous hydroxide to have an olive-green color (they previously viewed it as pale green) and they see plutonous fluoride as a pale green gelatinous precipitate (previously seen as white or pale yellow).

12/11/42

I had a talk with Compton today, who has just returned from Wednesday's S-1 Executive Committee meeting in Washington. He bore the good news that the Berkeley 94 chemistry project contract has been approved for renewal. The principal business of the Committee, however, was to make some decisions about the recommendations set forth in the report of the Lewis reviewing committee. The report was favorable to the Met Lab: it recommends that our pile program go ahead as planned without delay. Groves agreed with one exception; in his draft report to President Roosevelt he recommends we skip an intermediate pile in order to save time. Lewis and his committee also recommend the construction of a full-scale gaseous diffusion plant for concentrating U^{235} . As for Lawrence's electromagnetic process, they feel that 22,000 present-type calutrons would have to be in operation to produce the required amount of U^{235} ; so they suggest that a small plant of only 110 calutrons be constructed to give a total of 100 grams of U^{235} . Conant does not want to abandon the electromagnetic process as an alternative means of procuring fissionable material; he is, therefore, disregarding the recommendation and will press to get 500 to 600 calutrons of an advanced type built in order to provide 100 grams of U^{235} per day.

Following my talk with Compton, I wrote to Latimer in Berkeley, notifying him that his contract has been officially approved and that he will be receiving a letter of intent in a week or so. I told him that before submitting the contract to the S-1 Executive Committee I raised the salary ante to \$40,000 (of which \$7,000 is University of California overhead), making the total come to \$70,000 instead of \$60,000, so he can now make some needed salary adjustments. "In view of the stupendous job which we have in front of us," I wrote, "I should like to see even further expansion in manpower, provided this is possible; at least it will be possible from the financial standpoint." I went on to say that I am not having much luck in finding any good bachelor men to add to my staff.

In my letter I brought Latimer up to date on Hamilton's visit here. "It has been decided that the physiological reactions to 94 should be investigated, in view of the possibility of its ingestion by some of the workers, and Joe Hamilton has been authorized to conduct these investigations. Joe will need to know about the chemical properties of 94

12/11/42

in order to do his work. In view of the very restricted nature of this information, it has been decided that Joe, and Joe, alone, may have this information and that he himself will perform the experiments. He will not receive the CN-reports himself, but he has been authorized to see your reports whenever he finds it necessary. He has access to, and has been studying, the CN-reports in my office during his present stay in Chicago."

I concluded my letter by announcing my visit to Berkeley early in January. A reservation on the January 2 Streamliner has already been made for me, which means I will arrive in Berkeley the morning of January 4 if I can get away from the Lab.

Soon we will be in our new chemistry headquarters on Ingleside Avenue. So far no one has troubled to give the new building a name. The transfer of equipment and materials has actually begun, and we shall probably be completely out of Jones Laboratory in about another week or ten days.

Newspapers say the battle continues to rage in North Africa and that there is hand-to-hand fighting in Buna (New Guinea) in the Pacific.

Saturday, December 12, 1942

Cunningham and Werner, working with Kirk, started today to put into operation in our new chemistry building the quartz fiber torsion ultra-microbalance which has been built for us by Kirk and his co-workers at Berkeley.

During the last few weeks English and Ghiorso have been working on the methods and instrumentation needed for control work on 94 to be used in the chemical extraction plant. The problem is to take 94^{239} samples at each stage of the chemical extraction process for the determination of their Pu^{239} content by alpha particle counting. The method they are evolving contemplates precipitating lanthanum fluoride from the aqueous control samples in order to separate the 94^{239} in a form suitable for alpha particle counting. The alpha counting is complicated by the

12/12/42

presence of fission product radioactivity in the 94^{239} samples, and thus it will be necessary to develop instrumentation that will allow the counting of alpha particles in the presence of fission activity.

Allison sent a memorandum to all Chemistry Group Leaders. He and Mulliken have revised the system of monthly chemistry reports so that the reports are issued according to topic rather than to the groups of people who carry out the work. This is being done to make the distribution of information easier and to make the limitation of information more feasible. Classification is as follows: CC Analytical; CC General—contributions on the chemistry of materials of interest to us but in which radiochemistry, if any, plays a minor part; CC Radiochemical—contributions on fission products here and at Ames, but not directly concerned with biological effects or with U^{233} and 49; CN Reports—investigations on the chemistry of 49, including engineering, but not its final purification; CT Reports—studies dealing with technology, such as casting, coating, production of metal or carbide and metallurgy.

Kirk has spoken to me about the availability of Richard S. Rosenfels, a plant physiologist in Stockton, California, who got his Ph.D. from Berkeley in 1933 and has experience in microchemistry. Today I sent off a telegram to him saying that Kirk, upon his return to Berkeley, will talk to him about a job with our group in Chicago.

I interviewed in my Jones Laboratory office John Crawford, an excellent man with electronics experience who is currently employed as a civilian with the U.S. Signal Corps, for a position as Research Assistant. I then wrote a memorandum to Moulton asking him to offer Crawford a position because we desperately need someone with electronics experience; since hiring Ghiorso, we have been unable to find an additional man with the necessary qualifications. Crawford's wife was born in Germany and came to this country in 1937. I mentioned this hiring complication to Moulton saying, "Perhaps this will lead you to want to have Mr. Crawford cleared by the FBI before we have him come to work, but I would rather have him come to work sooner than this if you think that it is safe." I

12/12/42

added that his wife will be eligible for citizenship within a month or so because of her marriage and "her feelings are distinctly anti-Nazi."

Hall at the University of Wisconsin replied to my letter of December 7. He says that La Chapelle is of a definitely superior type and should develop very satisfactorily. He heartily recommends him, although he would not like to see him interrupt his studies at this time. He also suggests that I might be interested in Gordon Johnson, who, he said, is certainly one of the best seniors remaining in his department.

Sunday, December 13, 1942

Cunningham and Werner today continued checking on the new ultramicrobalance which they set up for operation yesterday.

Helen and I spent a pleasant afternoon with Vance R. Cooper, a chemistry classmate of mine at UCLA, and his wife Mary. At our invitation, they drove up from their home in Morris, Illinois, a town about 60 miles away on the other side of Joliet. It was only recently I learned through mutual friends that they are living in Illinois and that he works for du Pont as the superintendent of power and maintenance for the plant in Morris. Vance is a chemical engineer with a master's degree from Michigan. During his visit, I proposed that he come to work for the Met Lab in the chemical engineering group. I said we need his talents and the work here would be more in line with his training and interests. He expressed considerable enthusiasm. I pointed out that if he does make the change, it would probably mean that he will have to take a cut in salary; however, I would see what I could do for him.

Monday, December 14, 1942

Kirk ended his visit to the Met Lab and returned to Berkeley. We will be negotiating about his returning here as a Research Associate; but first he will build two more quartz fiber torsion ultramicrobalances for

12/14/42

Berkeley 94 chemistry groups, one for Latimer and the other for Kennedy, as well as one for himself to experiment with.

Good news from the African front today as Rommel's line in Egypt has been broken.

Tuesday, December 15, 1942

Thompson, James and Koshland have performed experiments using U^{+4} instead of zirconium as the carrier in the phosphate method, but these do not show any improvement over the use of zirconium. They have also precipitated uranium peroxide as a carrier for 94 from 20% uranyl nitrate solution but find the carrying is not satisfactory. Today they made the important test to determine whether zirconium phosphate carries 94 in its oxidized state. This would be important, if 94 is not carried, in devising an oxidation-reduction cycle for the phosphate method. They oxidized the 94 tracer with 0.1 M potassium dichromate in 20% UNH solution with varying concentrations of nitric acid at 65°C for 30 minutes. They find in most cases that more than 95% of the oxidized 94 is not carried by the zirconium phosphate, a hopeful result for the design of a phosphate process based on the oxidation-reduction principle.

Working on the ultramicroscale, Cefola has tested the solubility of Pu^{+4} in 10 N NH_4F . His results indicate a value of 450 mg of 94 per liter as a minimum value for the solubility. The purpose of this experiment is to test the possibility of a process to separate 94 from the rare earth fission products which have been precipitated as the insoluble fluorides, a process which was tested by Kohman on the tracer scale last month. Thus Cefola's result indicates that this method of separation should be applicable at high concentrations of 94 as well as on the tracer scale.

Perlman and I are submitting a report, CN & CF-380, entitled "Special Problems in the Chemistry of 94." In this we give a careful and comprehensive discussion of the degree of purification required in the removal

12/15/42

of light element impurities from the final 94^{239} in order to make it suitable for use in a weapon. By considerations of neutron yields from α, n reactions, taking the energy of 94^{239} alpha particles to be 5.15 Mev, we deduce the permissible levels of impurities in 94^{239} to be as follows (in parts per million of Pu^{239} : Li, 0.5; Be, 0.1; B, 0.2; C, 20; N, no restrictions; O, 100; F, 5; Na, 20; Mg, 100; Al, 20; Si, 200; P, 100; S, 10,000; Cl, 1,000; K, 1,000; Ca, 10,000; Ti, 4,000; and Fe, 40,000. We point out that these requirements place only minor limitations on the extraction and decontamination processes but place difficult requirements on the purification and metal production processes. We then go on to describe the possible purification processes that might meet these purity requirements, including the precipitation of 94 peroxide and the volatilization of the higher fluoride of 94 , and also discuss the reduction to the metal using methods patterned after the reduction of uranium to the metal. This part of the discussion follows pretty closely our contribution to the "Report on the Feasibility of the '49' Project" of November 26, 1942. We also include a section on "A Possible Slow Neutron Chain Reaction in the 94 Undergoing Extraction and Purification" which follows closely our discussion in our December 1, 1942, supplement to the November 26, 1942, report.

Today Perlman and I signed a patent petition for a case entitled "Peroxide Process for Separation of Radioactive Materials" which covers our peroxide method for separating 94 from fission products and uranium.

I replied to Professor Hall's letter of December 9 regarding La Chapelle saying that I can very well understand his reluctance in interrupting the graduate studies of a man of this caliber. I proceeded to tell him that the work here is of utmost importance and that our promising young bachelor's men are given training and work that tax their abilities and is in many ways comparable with graduate work. Enclosed was a copy of a letter I have written to La Chapelle offering him a position with us. We are interested in the other man, Gordon Johnson, I said, but our main concern right now is to find some men who can start to work as soon as possible.

12/15/42

In our group meeting tonight, in addition to our regular review of the status of our research program, we had much to talk about--my talk with Compton, last Friday, the proposed recovery of 94^{239} from the pile at Argonne, Cunningham and Werner's isolation of the large amount of 94^{239} from Chicago II, Kirk's new ultramicrobalance, our current move into the new chemistry building.

Rommel's troops in Africa are fleeing; the Allied pincer is getting smaller as they close in.

Wednesday, December 16, 1942

Using the new stock of 94^{239} for which they completed the isolation last Friday, Cunningham and Werner have tested the carrying power of lanthanum fluoride for plutonium at La:Pu ratios of 50:1 and 10:1, which corresponds to ratios which might exist in the extraction plant. They find that at a concentration of La^{+3} of 0.5 mg per cc, lanthanum fluoride carries 99% of the plutonium at a weight ratio of $\text{La}^{+3}:\text{Pu}^{+4}$ of 50:1 and 99.5% at a weight ratio of 10:1. They also have tested the carrying power of zirconium phosphate for plutonium at a Zr:Pu ratio of 100:1 because plant scale operation of the phosphate method for extraction of 94^{239} might require extraction of plutonium at carrier product ratios of 100:1 or lower. Carrying out the precipitations from 20% UNH solution, they find that when the acidity is 3 N in HNO_3 the plutonium is only carried to the extent of about 15%, whereas when the concentration of nitric acid is reduced to 1 N the plutonium is carried to the extent of about 78%. They also tested the carrying of plutonium by thorium iodate at a weight ratio of Th:Pu of 100:1. They find that plutonium is carried to the extent of 99% both in the absence of UNH and in the presence of 10% UNH.

A report entitled " U^{233} Production and Extraction" (No. CC-384) is being issued covering the period to December 15, 1942, inaugurating a new monthly series of reports summarizing progress of work on U^{233} . This report opens with a section "General Considerations on the Production of U^{233} " written by me. Here I amplify the general considerations that I

12/16/42

covered in report CF-268 issued on September 18 of this year. I describe the methods of production of U^{233} through the bombardment of Th^{232} by the neutrons produced in a chain-reacting pile, its possible use as an alternate source of energy for a nuclear weapon should the use of 94^{239} or U^{235} prove to be not feasible, and various methods of chemical separation of the U^{233} and its immediate parent Pa^{233} from the neutron-irradiated Th^{232} and fission products. Also included are a report by R. W. Stoughton of the Berkeley Laboratory on "Production of U^{233} by Use of Thorium in Conjunction with the Uranium Pile," a report by B. J. Fontana of the Berkeley Laboratory on "Separation of Minute Amounts of Uranium from Large Quantities of Thorium by Ether Extraction," a report by Brown and Hill on "Volatility Methods for Isolating U^{233} ," and a report by A. C. G. Mitchell of Indiana University on plans to make measurements on the beta particles of Pa^{233} . Stoughton at Berkeley is now working full time on the U^{233} problem while Fontana is devoting some of his time to this problem but is phasing into other work on plutonium chemistry.

I wrote to Latimer, primarily to inform him of the new type of "limited" report originating from here and how he should carefully control its distribution at his end; these will have the designation "CN and CF." These CN (covering plutonium chemistry) and CF (covering fission measurements) reports deal with the subjects that I discussed with him during his last two visits here, namely, (1) the purification of the final product and the production of plutonium metal and (2) the possibility of premature explosive chain reactions occurring during the extraction and purification procedures.

My letter continued, saying that I haven't heard anything officially as to du Pont's decision whether or not to take over the engineering work for our entire Project, but my feeling is that they will accept the offer to do so, and that the chemistry responsibility will be divided about as follows: Du Pont will undertake to extract and "decontaminate" the product; and the 94 chemistry development groups (at Chicago and Berkeley) will (1) transfer extraction and decontamination procedures to du Pont and continue developmental work on such procedures and (2) take over the decontaminated product to purify it and change it into the metallic form. I mentioned the beautiful ultramicrobalance that Kirk has delivered to us.

12/15/42

I asked Latimer's opinion about Koch and Mastick, two men working in the Chemistry Department at Berkeley, whom Kirk has highly recommended as microchemists, and who might be available for work on the 94 project. I asked if he has seen the article by Hahn and Strassmann that appeared in the April 1942 issue of Naturwissenschaften. "If you haven't," I said, "I would recommend that you do so. They have done an amazing amount of very interesting work on the chemical properties of 93. I must confess that I don't understand just why this work is being published; it seems very mysterious that this work should be made public."

The Health Group issued a monthly report, CH-396, bringing everyone up to date on its activities. As a result of their clinical work, they have found only a few cases here of over-exposure to radiation; however, protective measures are being increased. Animal experimentation has revealed that uranium oxide and uranyl nitrate are very toxic if they get into the blood stream, but not if ingested. Tracer experiments indicate that yttrium, strontium and many other fission product elements will localize rather quickly in bones, but that xenon concentrates in fat. Exposure meters for detection of radiation, particularly neutrons, are being improved.

The Met Lab has steadily been augmenting its staff of employees. For example, during the last month the following new employees were hired: research associates (4), research assistants (3), laboratory assistants (1), technicians (1), laboratory boys (1), stenographers (3), engineers (2), guards (12), janitors (6), truck drivers, carpenters and shopmen (6). The new Research Associates are Waldo E. Cohn in the Health Group (Ph.D., California), Forrest H. Murray in the Theoretical Group (Ph.D., Harvard), Edward Shapiro in Burton's Chemistry Group (Ph.D., Purdue), and Katherine Way in the Physics Group (Ph.D., North Carolina).

Allison sent me an invitation to attend tomorrow's meeting of the Technical Council, which will gather in Room 209, Eckhart Hall, at 2:00 p.m. There are four topics planned for the agenda: (1) Compton will summarize the present status of negotiations with the du Pont Company. (2) Allison will report on plans for the analytical controls connected with

12/16/42

the production of heavy metal. (3) A request by Christy for a more thorough study of heavy water possibilities will be considered. (4) The current status of plans for the construction of the Argonne pile will be reviewed.

Thursday, December 17, 1942

The regular meeting of the Chemistry Division was held in Room 209, Eckhart Hall, from 9:00-10:00 a.m. this morning. Attendance has been expanded to include, besides myself, Adamson, Allison, Boyd, Brown, Burton, Cooper, Coryell, Cunningham, Franck, Neubert, Perlman, Spedding, Szilard, Teller, Vaughan, Wheeler and Willard. Reports were made by Adamson of Boyd's group and Willard of my group on adsorption methods being investigated for use in the separation of 94 from uranium and fission products. Adamson described work on the use of ion exchange resins and Willard reported on the use of inorganic adsorbents. Neubert described plans for work on testing the effect of radiation on adsorbents.

Today I submitted to Captain A. V. Peterson a supplemental report, "Use of Fission Activity for Military Purposes" (an addendum to my report to him of November 12). In this I present data compiled by Willard from various reports on the radiation energies and half-lives of fission products with half-lives greater than one week and data on the percentage of total beta fission activity and total gamma fission activity due to different elements at various times after shutdown of a pile operated for 40 days. The purpose of this information is to aid an evaluation of whether any of these fission products might be useful for use as a war weapon.

I wrote a report for Hilberry entitled "Desirability of Operating Argonne Pile," which stresses the importance of, and the reasons for, producing $^{94}_{239}$ for our chemical experiments; this is in response to the request made to me at the Technical Council meeting last Thursday.

12/17/42

At two o'clock in the afternoon I went to Room 209, Eckhart Hall, and attended a meeting of the Technical Council. Topics discussed were those mentioned on the invitation I received from Allison yesterday.

Cunningham today began moving from Jones Laboratory to his new quarters in the new chemistry building. Covey has returned from California and is helping to move the equipment and materials.

Winstein replied to my letter of December 7. He said that he will be on the lookout for men finishing up this semester at UCLA and will let me know about prospective employees for my group. "It is uncertain what will happen to UCLA next semester," he wrote, "and you may have your choice of half the place, including me. We're expecting news on the situation very soon. You probably know UCLA licked S.C. to get the Rose Bowl bid. Some fun!"

Friday, December 18, 1942

A report, No. CF-392, entitled "Fast Neutron Research" has been issued for the period ending December 15, 1942. This includes summaries of research on fast neutrons as they relate to the use of fissionable material in a nuclear weapon. Under the new scheme where work is published by topic rather than by group, this is where two reports by my associates and me wound up. One section, "Slow Neutron Fission Cross Section of 94^{239} " by English, Ghiorso and me, covers work done here at the Metallurgical Laboratory. This describes our determination of the ratio of the slow neutron fission cross section of 94^{239} to that of U^{235} , measured using a sample of pure 94^{239} and of natural uranium with neutrons furnished by our one-gram Ra-Be neutron source with the neutrons slowed by paraffin. We report that the ratio of the slow neutron fission cross section of 94^{239} to that of U^{235} is 2.0 ± 0.6 . Our second section, entitled "Fast Ra-Be Neutron Fission Cross Sections of 94^{239} , U^{233} , U^{235} , U^{238} and Pa^{231} ," consists of the report by J. W. Gofman, R. B. Duffield, C. G. Blanchard and me that covers the work done at Berkeley started while I was there and continued after my departure. The relative fission cross

12/18/42

sections were measured using the fast neutrons from a one-gram Ra-Be neutron source. The samples were placed in the usual manner on one electrode of a shallow ionization chamber connected to a pulse amplifier and recording system, adjusted so as to record the impulses due to fissions. The ionization chamber was cadmium lined, surrounded by a boron carbide shield, and the entire assembly was mounted on a steel table in the absence, so far as possible, of hydrogenous material. The results are summarized in the following table:

Relative Fast Neutron (Ra-Be)
Fission Cross Sections

<u>Sample</u>	<u>Isotope</u>	<u>Weight in μg</u>	<u>Fission rate (counts/hr)</u>	<u>Fission rate per μg (counts/hr)</u>	<u>Relative cross section</u>
I	${}_{94}^{239}\text{Pu}$	1.15	11.4 \pm 0.41	9.90 \pm 0.35	1.93
II	${}_{94}^{239}\text{Pu}$	1.15	11.2 \pm 0.38	9.74 \pm 0.33	1.90
III	U^{233}	0.8	8.34 \pm 0.43	10.4 \pm 0.54	2.04
IV	U^{233}	3.8	38.7 \pm 1.7	10.2 \pm 0.45	2.00
V	U^{235}	18.5	94.5 \pm 1.2	5.11 \pm 0.07	1.00
VI	U^{238}	188.6	384.0 \pm 2.1	2.01 \pm 0.01	0.39
VII	Pa^{231}	17.9	69.7 \pm 2.4	3.89 \pm 0.13	0.76
VIII	Pa^{231}	6.6	24.3 \pm 0.9	3.68 \pm 0.14	0.72

These results are in fairly good agreement with our Berkeley report "Fission of ${}_{94}^{239}\text{Pu}$ and U^{233} by Fast Ra-Be Neutrons" by G. Friedlander, J. W. Gofman and me, issued last summer on August 5 (CF-221).

Cunningham completed his move to his new laboratory and the move for the remainder of us started today.

Latimer wrote me a letter about the manpower problem, which I will quote just as he wrote it.

"I got back in Berkeley on Sunday after an exciting week with the Army.

12/18/42

"One matter has come up which seems to me to involve some rather general planning. As you may have heard, it appears likely that Oppenheimer will put Kennedy in charge of a laboratory in site Q to find out experimentally the answer to the cross section and stability problem. He would like to take Wahl, Duffield and Garner with him. I am most anxious to cooperate in every way and will be sad but willing to have these men go, but it does seem to me to be a problem which involves the coordination of all phases of the work and requires a general discussion with Compton, Oppenheimer and yourself. I believe the whole plan is still tentative and I am not sure how much you know of it. I think that we could lose these men and still carry on but naturally it will require a little time to build up momentum with replacements. Dr. Makower in the Albany laboratory, who is one of Bray's old students and a really top inorganic man, is available. When the work gets out of the semi-micro stage I think that he would be most useful. We have taken our three best seniors (have taken over two of these men and will work out some plan of sharing the group with you) here for teaching fellowships and none of the other boys graduating in February are really top men, but one or two are reasonably good. I am still working on that problem and hope to get at least one of them to come to Chicago. The manpower problem is certainly getting acute but if necessary I can use drastic methods and pull some men off of other jobs."

"Site Q" that Latimer refers to is the fast neutron laboratory that will be set up in New Mexico by Oppenheimer; it is more generally referred to as "Site Y." It is to be located in an isolated mountainous region, on top of a mesa, about twenty miles northwest of Santa Fe. There are a few buildings there already, because the Los Alamos Ranch School for boys is vacating the premises. The site was chosen by Oppenheimer, McMillan and Groves only last month, thus settling once and for all the controversy about locating the new fast neutron laboratory at Site X, Argonne Forest, or some other less remote place.

Benedetti-Pichler wrote from his office at Queens College, Flushing, N.Y., seeking advice or aid for a student, Paul E. Rochford, who is graduating next June but who has been doing microchemical work for almost a year. Rochford is interested in building a quartz fiber microbalance

12/18/42

but has no clear fused quartz and, according to Benedetti-Pichler, Queens College feels it has a patriotic obligation not to waste anything on "fancy hobbies". I was asked if I could make any suggestion how to get defense money for the project, even though the outlay would be ridiculously small.

"Personally," Benedetti-Pichler said, "I am doing fine. I have so much literary work to do that I have no time to notice the lack of research facilities. I expect to remain busy in this manner until I am able to equip a research corner in my home." He ended his letter by saying that he is looking forward to having a chat with Cefola at Christmas time, "provided that his train does not get stuck somewhere. Former students of mine, who are working in Delaware and Kentucky, told me some tall stories on train service."

Nick S. Dallas is a senior in chemistry here at the University and needs to take only one three-hour course to finish his undergraduate training. Today I got word from Moulton's office that he can come with my group as a Research Assistant.

La Chapelle replied to the job offer I made him earlier this week, saying that he is definitely interested. He is coming down from Madison, Wisconsin, tomorrow by Chicago & Northwestern train for an interview and will get in touch with me by telephone as soon as he arrives at the station.

Saturday, December 19, 1942

Today Thompson tested the use of bismuth phosphate as a carrier for 94 in its reduced state with rather encouraging results. Upon precipitating relatively high concentrations of bismuth (15-25 mg per 10 cc) as bismuth phosphate from 20% UNH solution, he finds the 94 to be carried to the extent of more than 85%. The bismuth phosphate precipitates are slow in forming and require digestion at temperatures of the order of 75°C. He finds that the bismuth phosphate precipitate is very dense and crystalline, which are desirable properties, and dissolves readily in HCl.

12/19/42

In view of Thompson's results on the carrying of Pu^{+4} by bismuth phosphate, Cunningham and Werner made an immediate test today to see whether it is carried at a ratio of $\text{Bi}^{+3}:\text{Pu}^{+4}$ of about 100:1. Their results indicate that under conditions similar to those of Thompson's experiment, the Pu^{+4} is carried to the extent of 98%. This was fast work and illustrates the pace at which our group is now working. They also made a test of the carrying of Pu^{+4} by hafnium phosphate at a ratio of Hf:Pu of 100:1 and they find that about 90% of the Pu is carried.

Report No. CN-391 entitled "Chemistry of 94" is being issued, which includes the work of my group C-V for the period December 1-15, 1942. This follows the new format of covering all the work on a topic rather than the work of a group, as has been the case in the past. My part of the Report includes a section by Perlman on "General Problems in 94 Chemistry" in which he gives a general overview of the process for separating 94 from the neutron-irradiated uranium in the pile and carrying it through to its final purified form. He identifies the "extraction process" as the first step in which a crude 94 product is separated from the uranium and from as much as possible of the fission activity. The crude 94 product in this stage might be present with amounts of carriers of the order of magnitude of several pounds and will still contain far too much fission activity to allow direct handling. As a result, the crude 94 will have to be subjected to a second series of steps, the "decontamination process," which will consist of freeing the 94 from sufficient amounts of fission activity (by remote control) so that it can be handled directly. One method of decontamination might consist of a series of self-purifying oxidation and reduction cycles.

If it is assumed that as much as 0.5 kg of 94 will be present in a single batch, there will be also present about 5×10^5 curies of gamma activity before the extraction step. The extracted crude 94 might then be accompanied by 10^4 curies, that is, a 50-fold reduction of gamma activity can be expected to take place in the extraction process itself. The following oxidation and reduction cycles might reduce the gamma activity to 0.1 curie or less.

Finally there will be the "purification process" in which the 94 will

12/19/42

be separated in essentially pure form, that is, separated from the carrier material. This step has of necessity received less consideration than the extraction or decontamination steps and its final development cannot be accomplished until larger amounts, perhaps gram amounts, of 94 are available.

My section of Report No. CN-391 then goes on to describe the work of Brown and Hill on the volatility and stability of 94 hexafluoride; the work of Thompson, Koshland and James on the zirconium phosphate method for separating 94; the ultramicrochemical work of Cunningham and Werner on the carrying power of lanthanum fluoride, zirconium phosphate and thorium iodate for plutonium at high plutonium ratios; and the work of Cefola on the solubility of plutonium fluoride in 10 N NH_4F .

The remainder of Report CN-391 consists of a section by Latimer's Berkeley Group on "Acetate extraction process," by Charles Cooper on "Development of extraction plan design," by Burton on "Solvents and solutes" and "Effect of radiation on adsorbents," by Spedding on "Chemistry of Elements 93 and 94," and by A. C. G. Mitchell on "Internal conversion in element 93." This new method of reporting places less burden on my office.

La Chapelle called me this morning as he promised, and I invited him to come to my new office (Room 15) in the new chemistry building for the interview. I believe that our meeting was fruitful, because he agreed to join our group as soon as possible. Later he got together with Kohman, his friend, before returning home to Madison.

Harry W. Fulbright, who is now in charge of the cyclotron for the Physics Department at Washington University, St. Louis, wrote me a letter concerning our present bombardments. We are now getting express shipments of uranyl nitrate from the cyclotron on a weekly basis. Each sample weighs 200 grams and is subjected to 5,000-10,000 microampere-hours (deuterons on beryllium) of neutron bombardment. These serve as a continuing source of 93^{239} and fission products.

Fulbright explained how our samples, including the 300 pounds of UNH in assorted boxes that have been under neutron bombardment since November 19 (Chicago III), are being handled. All the boxes and much of the graphite

12/19/42

and paraffin shielding are mounted on a 3/4" plywood sheet so that all of it can be shifted about when necessary without disturbing the geometry of the stack. The plywood sheet rests on wooden dowel rods so that it can be pulled onto the table that Covey put together when he was in St. Louis last November 4-5. The table can then be rolled away when repairs have to be made in the target region, or when a phosphorus bombardment has to be made for the medical people on the campus there. Fulbright said that the plywood sheet with its stack has been moved away seven or eight times with only one mishap that could have been avoided. He added that "right now the whole target region just blazes with activity," but that the operator receives only a small exposure, mostly from the radioactivity of parts of the cyclotron itself rather than from our samples. The total number of microampere-hours that our 300-pound sample has received to date is 74,000.

It has been snowing heavily the last few days and this evening, and snow is beginning to pile up.

Bombers from the U.S. have been active over Axis-held Tunisian bases for eight days and have set a warship on fire near Bizerte.

Sunday, December 20, 1942

Today the Chicago Sun says "Soviets Open 3d Winter Drive" with an offensive in the Don River area with 30,000 Germans killed or captured.

Monday, December 21, 1942

I answered Fulbright's letter of December 17, thanking him for the information about the cyclotron bombardment of our nitrate samples. I asked him to be on the lookout for a brass cylinder of UF_6 that Brown has shipped for neutron irradiation to replace the one that is now being irradiated (designated F-6-1). I also asked him to increase the weekly monitor samples from 200 to 400-500 grams and told him we will let him know if we want to go beyond 100,000 microamperehours on the Chicago III bombardment.

12/21/42

A letter arrived from Kirk in Berkeley, thanking me for the courtesies extended him while here. He wrote that he is now trying to arrange matters in order to join my group about the first of February. He has contacted Rosenfels and Clifford Smith about joining him. To quote, "Rosenfels is fairly bursting his boiler to get started doing something. He made me assure him that the project has something to do with the war, and on receiving that assurance he was ready at any time. I also called Cliff Smith, and he will come in tomorrow to talk with me about it." He also described the progress being made in the design of the centrifuge his group will be constructing for us.

I received a letter from Makio Murayama, asking me to provide information as to his character and abilities to Count Alfred Korzybski, Director of the Institute of General Semantics in Chicago and a former officer of the General Staff, who is trying to help him get security clearance from the FBI so that he can work for me. I knew Murayama as a student in one of my freshman chemistry laboratory sections at Berkeley. My letter to Korzybski reads as follows:

"I have heard that you are undertaking to aid Mr. Murayama in the matter of obtaining clearance so that he may be eligible to accept a position in some capacity connected officially with the war effort. My associates and I have known Mr. Murayama for several years and are agreed that he is a very capable scientist and that his abilities should be used. In my contacts with Mr. Murayama I have found no reason to question his loyalty to the United States.

"While I do not have the authority to offer any particular man a position with us, since this function is fulfilled by the administration here, I do want to say that if Mr. Murayama were granted complete clearance by the Intelligence, I would immediately request our administration to offer him a position with my group. I am definitely in need of a man with the training and ability which Murayama possesses."

The Soviet army continues its drive across the frozen Don plains at a rate of sixteen miles per day.

Tuesday, December 22, 1942

Thompson conducted another experiment on the carrying of reduced 94 by bismuth phosphate. He used 10 mg of bismuth per 10 cc of 20% UNH solution which was 1 M in HNO_3 and had a phosphoric acid concentration of 0.35 M. He digested the precipitate at 95°C for an hour, separated the bismuth phosphate by centrifugation, dissolved the bismuth phosphate in concentrated hydrochloric acid, diluted the solution and added lanthanum carrier and HF to isolate the 94. He finds the yield of 94 to be 75-80% in two such experiments. He then repeated the experiment using a higher concentration of bismuth (25 mg per 10 cc) to determine the separation from fission products and finds that the final lanthanum fluoride precipitate contains about 10% of the initial fission activity.

Jaffey, in collaboration with Brown and Hill, has been conducting experiments on the carrying of 94 in the reduced state by lanthanum carbonate precipitated by the addition of bicarbonate ion. He finds that 94 can be carried to the extent of greater than 90% when the pH is adjusted to the range of 6.5-7.2. He also finds that under these conditions 94 in the oxidized state is not carried. Their experiments also show that the bulk of the uranium can be precipitated as U^{+4} , without carrying the 94, at higher acidity, i.e., by the addition of bicarbonate ion at a pH of about 3.0. This might form the basis for a separation procedure based on the removal of uranium as the carbonate followed by the isolation of the 94 from the supernatant solution using oxidation-reduction cycles with lanthanum carbonate as carrier.

I have received the minutes of a conference held last week in Wilmington, Delaware, which was attended by Whitaker, Moore, Wheeler, Cooper and Wilson of our Laboratory and H. T. Daniels, C. C. Lockhart, J. A. Burns and F. McLellan, of the du Pont Company design group. The purpose of the conference was to discuss Pile III. Some of the topics brought up were as follows:

(1) The assumption that du Pont will assume design for the complete plant, including site development, all facilities, and the plant proper, is correct.

12/22/42

(2) No site has been selected.

(3) The operating level for each pile is being designed for 250,000 kw, instead of 100,000 kw previously set forth in the Moore and Leverett report dated September 25, 1942. Four pile units will be installed having a total capacity of 1,000,000 kw. Operating at a 60 percent load factor, these four units will produce 600 grams of plutonium per day.

(4) The safety distance between units will be decided at a later date. The opinion was that units could be spaced relatively close together as an area, and that this area should be four miles from the chemical separation plant.

(5) It was estimated that metal would be unloaded from the pile at a rate of 20 tons per day, which would indicate that intermediate storage (wet or dry) would be required in view of the estimated consumption at the separation plant of six tons per day. It was considered advisable to develop means for separating the graphite from the uranium metal at the reactor (pile).

(6) It is still the intention that the piles will be helium cooled.

(7) Du Pont does not intend to consider the design and construction of a 10,000 kw unit in addition to the 250,000 kw unit.

(8) It is understood that liaison between the Metallurgical Laboratory and the du Pont Company is being set up, but no definite information is available at this time.

The rest of the conference was spent in talking about a helium system, ventilation, shielding, control rods, and other such engineering problems.

In the evening Helen and I went to the Palmer House in downtown Chicago, where we joined the Met Lab chemists and du Pont engineers for a pre-Christmas celebration (\$3.00 per couple). Around 10:30, Dick Apple played Santa Claus, and to everyone's merriment, handed out gifts to which were attached personal, comic verses. All of us joined in singing a great number of songs, which was followed by dancing and by heavy drinking in some quarters. I would say the party was a success, although somewhat rowdy by the time we left.

Wednesday, December 23, 1942

Thompson repeated the experiment he performed yesterday to determine the degree of separation of the 94 from fission products using a number of holdback carriers for the fission products (lanthanum, cerium, yttrium, barium, strontium, ruthenium, thorium—0.3 mg of each per 10 cc of initial solution). He finds that along with a 98% yield of 94 only about 6% of the fission gamma activity and 9% of the fission beta activity comes through. The high yield of 94 indicates that a concentration of Bi^{+3} of 25 mg per 10 cc should be used, a higher concentration of carrier material than we have generally used in our co-precipitation experiments.

Cefola, working in collaboration with Magel during the last week, has tested the carrying of reduced 94 from UNH solutions by $\text{La}_2(\text{SO}_4)_3 \cdot \text{K}_2\text{SO}_4$ formed as a crystalline precipitate by the addition of excess K_2SO_4 . They find a somewhat erratic incorporation of 94 in the crystalline precipitate ranging from 20-100%, so it isn't clear whether this might form the basis for a successful process to be used in the separation of 94 from uranium and fission products. They performed their experiments with neutron-bombarded UNH and thus measured the incorporation of fission product activity in the precipitate and find that this corresponds, as expected, to that proportion that consists of the rare earths.

The Soviets have regained several villages as they drive toward the city of Rostov.

Thursday, December 24, 1942

Thompson repeated yesterday's experiment with the inclusion of zirconium carrier (3 mg per 10 cc) and finds slightly less gamma-ray activity (about 4%) and about the same amount of beta particle activity (about 8%) in each case in the final lanthanum fluoride precipitate.

Yesterday and today Cunningham and Werner tested the process proposed by Jaffey, Brown and Hill for separating 94 from uranium by precipitation

12/24/42

of the uranium with bicarbonate ion at pH about 3.0 at a U^{+4} :Pu ratio of 1,000:1. They find that the uranium precipitate does not carry the 94 in agreement with the tracer experiments of Jaffey, Brown and Hill.

Kirk wrote me in a letter dated December 22 that he, Craig and Boyer have been making many calculations the last few days on the centrifuge he is designing. He enclosed a rough graph of through-put versus rotor speed and asked that I decide on the through-put required so that he can draw up the final plans. He will then give the plans to Camenson (who operates a small company in Berkeley), who is willing to construct the centrifuge on a cost-plus basis. He said that he is considering some more microchemists who might be hired if needed. One in particular is Robert Lindner who got his Ph.D. in plant pathology at the University of Chicago. Lindner, he said, was one of the best men he ever had; they published several papers together, and he is top-notch. Unfortunately, he doesn't know where Lindner is living at present. He also said Camenson will have Cunningham's cones (micro test tubes) ready for him any day now.

Everyone worked as hard as usual today, despite the fact that tomorrow is Christmas. We did take off the last hour, however, to go to West Stands where all the Chemistry Division employees gathered for a Christmas Eve party.

MacArthur says that the position of the Japanese troops in the Buna area of New Guinea is hopeless.

Friday, December 25, 1942

This is the second Christmas that Helen and I have spent together, the first in Chicago since we were married. It has been a memorable day for us, especially because we were invited to join the Walter H. Zinns for dinner and their Christmas festivities. Wally was born in Ontario and is about five years older than I. He received his Ph.D. in physics from Columbia University. He taught at City College in New York City before teaming up with Fermi, Szilard and Herbert Anderson at Columbia last year

12/25/42

on exponential pile experiments and is in large part responsible for the success of the pile in West Stand--the first sustained chain reaction that we know of. We were particularly pleased to see the Zinn child--a cute and active boy--and to participate in the atmosphere of a family Christmas, for, after all, the day might have been somewhat lonely. Enrico and Laura Fermi and their children were also there, and this gave us an opportunity to get better acquainted with them under pleasant, relaxed circumstances.

Saturday, December 26, 1942

In view of Thompson's promising results on the carrying of 94 by bismuth phosphate, Cunningham and Werner today began experiments to test the carrying at a number of Bi:Pu ratios.

I dispatched a letter to Calvin to the effect that I plan to arrive in Berkeley on the Streamliner Monday morning, January 4, and will leave the following Friday. I asked him to arrange for a room at the Faculty Club for me during my stay.

I had a rather long conference with Compton this afternoon and came away with a feeling that everything went smoothly. It is apparently now settled that the 94 chemistry groups here and at Berkeley will be responsible for the purification and preparation of 49 metal. I told Compton that already at Berkeley preparations are being made for metal production and spectrographic analyses, and he was entirely in favor of it. He also agreed that although Latimer and I will eventually furnish Oppenheimer with some trained men, apparently there is no immediate need. He therefore thinks it might be wise to train one or two men here and at Berkeley specifically for this purpose. Compton was in an expansive mood and talked to me about the future of the whole project as he sees it.

Sunday, December 27, 1942

Thompson made another test of the bismuth phosphate process using 25 mg per 10 cc of bismuth in the initial solution, which he has decided is a satisfactory quantity—smaller concentrations lead to incomplete precipitation of bismuth phosphate and reduced carrying of 94. The purpose of today's experiment is to test the removal of fission product activity by a reprecipitation of the bismuth phosphate. He finds that this does not reduce appreciably the amount of fission product activity in the final lanthanum fluoride precipitate.

Monday, December 28, 1942

Cunningham and Werner have completed their ultramicroscale experiments on the carrying of plutonium (using 94^{239}) by bismuth phosphate from 20% UNH solution at a variety of Bi:Pu ratios with the following results. For a Bi:Pu ratio of 17:1 they find the plutonium carried to the extent of 98.9%; for 120:1, 98.5%; for 150:1, 99.4%; for 1,600:1, 98.5%; for 28,000:1, 98.4%; and for 150,000:1, 95.5%. These are very gratifying results and indicate that the bismuth phosphate process should meet the requirements for the higher concentrations of plutonium that would exist in production plant operation.

Willard and Turk have studied the co-precipitation of reduced 94 using 94^{238} tracer from 5% U (as UO_2Cl_2) solutions with lanthanum fluoride precipitated by the addition of KF or NH_4F in order to reduce the acidity to minimize corrosion of the equipment. At pH values up to 1.8 the 94 is quantitatively precipitated. They also find that lanthanum fluoride precipitated by the addition of KF to a solution of uranium containing excess bicarbonate ion carries about 75% of the 94 with most of the remaining 25% carried by a subsequent lanthanum fluoride precipitate produced by the addition of more La^{+3} .

12/28/42

I wrote a sympathetic letter to Benedetti-Pichler in response to his letter of December 16. I agreed that he and Rochford should have financial assistance in their microchemical development work and outlined the way that one goes about getting a Government contract. First, I said, it would be necessary to initiate a contract from the project here, between OSRD in Washington and Queens College. On such a contract Queens College would be responsible to the Government for the accounting of the money and the College, in turn, would make Benedetti-Pichler (as Official Investigator, the name given to this role) responsible for the accomplishment of the project as set forth in the contract. Even before negotiations for such an arrangement could commence, I told him, it would be necessary for the Intelligence Division of the Army to investigate him for a security clearance.

"If you think that there is too much bother attached to such a procedure," I continued, "I think there is, perhaps, another way out. If you will tell me what you need in the way of material and equipment, I am sure that I could send some of it to you from here. This I can do only with non-inventorial equipment, such as, for example, clear fused quartz. Dr. Cefola could undoubtedly be of aid to us in such an arrangement. Dr. Cefola is doing very fine work here. I saw him this morning after he returned from his trip to New York last weekend and was sorry to hear that he missed seeing you at that time. I am sure that he would have enjoyed very much having a long chat with you. Apparently he didn't have any trouble at all in respect to train service." In conclusion I asked Benedetti-Pichler to write and tell me which of the two arrangements would be most feasible for his project.

Early this morning I wrote a note to Latimer giving him the gist of my talk with Compton last Saturday. I said that he would be interested in hearing about the future organization of the whole project in general when we get together next week.

Greenewalt returned to the Laboratory today and will be here much of the time for the next few months in his capacity as the technical director of the du Pont division responsible for carrying through 94 production. Hilberry, Cooper and I had a meeting with him; and since we were together

12/28/42

until early afternoon, we arrived late at a meeting of the Technical Council, which was attended by Allison, Compton, Creutz, Doan, Fermi, Moore, Spedding, Wheeler and Wigner. I learned later that the meeting opened with a plea from Allison that the Lab should buy Magel a 20 kw induction furnace for experiments on the purification of 94 metal. It needs to be of the induction type because work must be conducted in a vacuum. For the time being, we are borrowing the 20 kw furnace that belongs to the technological group. Creutz offered to let Magel keep the furnace provided his group can get hold of a 50 or 60 kw outfit. Allison said we need this because my group has the job of preparing pure 94 in usable form. There is a long time delay in acquiring induction furnaces, even with AAA priority. In view of this Compton asked Doan to ask du Pont to order now all the furnaces they will need for Site Z (the site where the production piles [pile III] and the accompanying chemical extraction plants will be built, not yet chosen).

As soon as we entered the meeting, Greenewalt was invited to tell the Council about the du Pont involvement with the Metallurgical Laboratory. He said that du Pont finally agreed to take on the pile design—with considerable trepidation—ten days ago. An organization is now being set up under du Pont's TNX (explosives) Department. The general manager of this department is E. B. Yancey and the assistant general manager is Roger Williams, whom Greenewalt said is the best man in the company to translate a process into reality. R. Monte Evans, who has a Ph.D. in chemistry and is plant manager of the Morgantown ammonia plant, will be brought in as the production manager. Greenewalt himself will be the technical director who gets and passes on information. He went on to say that the du Pont Company is in no sense taking over development; it considers itself a handmaiden to the Metallurgical Laboratory, contributing a specialized technique to translate contributions into a working venture. Engineering aspects will be paramount at one stage, with chemical aspects paramount at a later stage. There is a time limit and a competitive element. He said du Pont is taking the assignment very seriously and using its best men.

Compton asked Greenewalt to tell us a little about his background, which I think merits repeating. Greenewalt received a degree in chemical engineering from M.I.T. in 1922 and went directly to work for du Pont, where "nylon was my magnum opus." He said that the subject of nylon would

12/28/42 .

serve as a good example of the translation of a laboratory idea to full-scale production; here, teamwork and every conceivable variety of talent were involved in the development. Carruthers discovered the class of superpolymers in 1930; in 1934 the first polyamid was synthesized that could be drawn out into fibers. The Seifert production plant was started in January 1940, but there were six years of intensive development in between, with heavy pressure from management. About \$20,000,000 was gambled on developmental work and the cost of the Seifert production plant. Greenewalt then drew a parallel between nylon and 94 production. This project, he said, is much more difficult, and only two years or less are available to bring it to fruition. Moreover, the pilot plant in the usual sense is impossible; it will be necessary to take chances at each stage of the work. He confirmed his belief that the present job can be done, with the reservation that all available talent will be needed in the effort.

Greenewalt said that the present feeling is that, unless there is a much better case for the water-cooled plant, a helium-cooled pile must be constructed. Du Pont hopes to have the first commercial unit going a year hence, with subsequent plants every few months.

Compton said that one justification for the 49 project is that there is the possibility of meeting an earlier time schedule than if only U^{235} were involved. Greenewalt agreed, saying that on a long-time basis the diffusion process (to separate U^{235} from natural uranium) is the most certain; however, the plant will be slow and hard to build. On the basis of 94 we have a chance to save a year. "Our problem," he said, "is one of time and dependability. Even if we lose to our domestic competition-- U^{235} --our efforts will not have been in vain. There should be no hesitation to spend an extra \$50,000,000 to insure reliability or speed." I remarked that even if the U^{235} project were to come in ahead, still 94 might have better nuclear properties for an atomic bomb.

Compton revealed an uneasiness on his part by saying, "If the objective is to produce 49 before 25, or before the Germans reach the goal, and if we find that after a year the helium-cooled plant does not produce, then we are already behind." Fermi tried to allay his fears by asserting that it is better to pick a possibility for a pile at random rather than to make no choice at all. Greenewalt agreed. He said: "We

12/28/42

have decided to go ahead on a full-scale helium-cooled plant hammer and tongs. The best second line of defense is considered to be a heavy-water pile, which is as different as possible from a helium-cooled plant." Fermi said that other possibilities should be studied, as one cannot tell what may develop; the war might last much longer than we expect. But he thought we shouldn't spend so much time on side lines that the main line will be delayed. Allison and Cooper then discussed problems that might arise with alternative kinds of piles, such as with the heavy water and uranium hexafluoride types. At the conclusion of the meeting, Doan pointed out that with the entrance of du Pont into the project we should expect a change in emphasis of work here; while there still will be a certain amount of development of new ideas in general, there will be more pressure on specific ideas. Greenewalt emphasized that the major part of the design data for the helium-cooled pile must be in the hands of du Pont in the next six months; after that there will be more opportunity to branch out.

War news today is encouraging as the Russian army continues its drive in the Ukraine and the United States won a big battle with the Japanese in New Guinea.

Tuesday, December 29, 1942

I have asked Turk to join with Thompson in view of the excellent promise of his Bismuth Phosphate Method for separating 94 (it has been necessary to put Koshland and James back on their other programs). Today Thompson and Turk made additional tests of the Bismuth Phosphate Method using lanthanum holdback carrier and reprecipitation of the bismuth phosphate but they observe no appreciable increase in the separation from fission products.

Our new electronics man, John A. Crawford, from the U.S. Signal Corps, started work today as a Research Assistant. Ghiorso, especially, welcomes him because he will now have more time for research and need not devote so much time to instrumentation.

12/29/42

I wrote a letter to Kirk in Berkeley concerning the centrifuge. I showed Kirk's letter of December 22 to Apple and Peery, two of the du Pont chemical engineers working with us, after which they wrote their comments and recommendations, which I now included. I ended my letter by saying that it seems fairly certain that my trip to Berkeley will go through as planned and that I will arrive there the morning of January 4.

This morning I also sent Kirk a wire asking if he has made any progress on his release from the University so that he can join us here in Chicago on a somewhat permanent basis. A response arrived this afternoon to the effect that he has a verbal release from the University and now only the details must be arranged.

At our group meeting tonight I described du Pont's decision to take on responsibility for the production aspects, i.e., the piles, as well as the chemical extraction aspects, of our Project. Thompson told us about his exciting new results on the carrying of 94 by bismuth phosphate. We also went over the various problems connected with our moving into our new building.

The Soviets are still making progress in the Ukraine on the 127th day of the siege of Stalingrad.

Wednesday, December 30, 1942

Yesterday and today Cunningham and Werner carried out a number of experiments with the Kirk ultramicrobalance to determine the effect of working with and around the balance on the stability of the rest point. They are preparing themselves for the use of the balance in their work.

During the last couple of weeks James and Perlman have been working on a method of concentrating the 94 from the solution produced by dissolving the uranium, 94 and fission products from a chain reacting pile in nitric acid. They have crystallized UNH from solutions of neutron-bombarded uranium, in which the solubility of the UNH was decreased by

12/30/42

adding excess HNO_3 . They find that they can retain about 80% or 90% of the 94 in solution after about 90% of the uranium has been removed by crystallization as UNH. On the basis of this they conceive of a counter-current process for the removal of uranium by crystallization as UNH, leaving the 94 in solution.

Our workshop here in Room 12 of the new chemistry building is woefully inadequate. Clyde R. Emery, who works under Thomas O'Donnell (the person in charge of the Met Lab shop department), has been here for the last ten days or so getting it in order. Someone in authority at the Met Lab neglected to order machine tools and supplies for us, so we must get along with fewer and cheaper tools, many second-hand, than would be required for the first-class machine shop that we previously planned. It will take at least four to six months to get delivery on better equipment. In addition to the Ryerson shop, which is well equipped, there are shops in West Stands, North Stands and Eckhart Hall. These subsidiary shops were made possible only by buying cheap and used equipment and by moving machine tools around on campus. Work has also started on the shop at Argonne Forest.

Today the Russians regained the city of Kotelnikovo, a key rail center.

Thursday, December 31, 1942

The meeting of the Chemistry Division, held in Room 209, Eckhart Hall, from 9:00-10:15 a.m. this morning, was devoted to discussions of volatilization methods for separating 94 from uranium and fission products. The attendees, besides myself, included Adamson, Allison, Borst, Boyd, Brown, Burton, Cooper, Coryell, Cunningham, Franck, Greenewalt, Jaffey, Magel, Perlman, Smith, Spedding, Szilard, Teller, Vaughan, Wheeler and Willard. Brown gave a report on the present status of the fluoride volatilization method. Magel summarized his experiments on the volatilization of tracer quantities of 94 from metallic uranium, indicating that 94 metal

12/31/42

has a higher vapor pressure than uranium metal. Johns focused on the volatility of fission products from uranium metal.

Today Thompson tested the use of sodium bismuthate as a potential oxidizing agent in the Bismuth Phosphate Process. He finds that after oxidation with sodium bismuthate only 20% of the 94 is co-precipitated with bismuth phosphate. This is very hopeful for the development of an oxidation-reduction cycle in the Bismuth Phosphate Process.

Brown and Hill fluorinated at 500°C for one-half hour four samples of lanthanum fluoride containing 94^{239} at concentrations from 0.002 per cent to 10 percent. They find that more than 99 percent of the 94 is removed as the higher fluoride in each of these samples. The purpose of this experiment is to determine whether 94 can be removed from a lanthanum fluoride precipitate in the Wet Fluoride Process, and apparently this is possible.

Today Brown and Hill also made a distillation of their neutron-bombarded UF_6 , 27.6 grams, which was exposed at the St. Louis cyclotron this month for a total of 22,000 microampere-hours (bombardment F-6-1, from December 16 to 29). The UF_6 was distilled from its container to another container but the measurements of the gamma-rays before and after the distillation didn't lead to a good material balance.

Korzybski replied to my letter of December 21. He intends to write to Washington as soon as possible to act on the status of Murayama. As usual, he said, it will probably take time for the people there to clear up the situation.

The year ends with the allies preparing for a big assault on Bizerte in Tunisia and the Soviets announcing new successes in its drive to regain Stalingrad.

JANUARY 1943

Friday, January 1, 1943

The most important news in the Sun today is about the Soviet front in the 130th day of the siege of Stalingrad. The Russians claim they have killed 175,000 Nazis.

Saturday, January 2, 1943

It has occurred to Thompson that some of the beta particle activity that follows through his bismuth phosphate-lanthanum fluoride cycle might be due to UX_1 rather than fission products (the UX_1 originating from the UNH in the initial solution). In an experiment today he finds that this is indeed the case and that his results last month on the separation of fission beta activity from element 94 by his process is actually better than his results have indicated. He also demonstrated today that bismuth phosphate dissolves readily in 10 N HNO_3 , does not reprecipitate when diluted to 6 N HNO_3 , but does reprecipitate when diluted below 6 N HNO_3 .

Report No. CN-405, "Chemistry of 94; University of Chicago Group C-V" for the period December 16-31, 1942, has been issued. This report is devoted entirely to the work of my group. It covers the work of English and Ghiorso on control processes for the measurement of 94^{239} ; the chemical extraction process of James and Perlman on the removal of uranium from 94 by partial crystallization of UNH ; the work of Thompson on his interesting new Bismuth Phosphate Process for the separation and decontamination of 94; the work of Brown, Hill and Jaffey on the carrying of 94 by lanthanum carbonate; the work of Cunningham and Werner on the carrying power of bismuth phosphate (and hafnium phosphate) for plutonium at high plutonium ratios; the work of Cefola and Magel on the precipitation of 94 with potassium lanthanum sulfate; and the work of Willard and Turk on the

1/2/43

precipitation of 94 with lanthanum fluoride under non-corrosive conditions at low acidities.

Ghiorso and English have recalibrated our "inside" alpha particle ionization chamber and now find an efficiency of 47% instead of 45%. A recalculation of the specific activity of 94^{239} as determined by Cunningham and Werner now therefore leads to lower values. Cunningham and Werner found a specific activity of 167,000 disintegrations per minute per microgram of 94^{239} last September and 163,000 disintegrations per minute per microgram of 94^{239} in October. Recalculated according to the new efficiency of 47%, these should be corrected to 160,000 and 156,000 disintegrations per minute per microgram respectively.

Koshland has been investigating a method of carrying 94 in its reduced state using thorium iodate and other iodates as carrier by precipitation from UNH solution. This method is being investigated at Berkeley. Koshland has investigated the precipitation of thorium iodate, bismuth iodate, partial precipitation of the uranium as uranyl iodate, and finds variable degrees of carrying of the 94. Under some conditions more than 90% of the 94 is carried by the insoluble iodate precipitate indicating that this method might have some potential.

I was not invited to attend the meeting of the Technical Council yesterday but have been briefed on what took place. James Franck attended for the first time. He is professor of physical chemistry here at the University and is the Nobel Prize winner in physics for 1925. Although Franck was an officer in the German Army during World War I and is on the U.S. enemy list, he is an expatriate. Recently, at Compton's urging, the S-1 Committee arranged for his security clearance so that he can work on the Met Lab project. Others present at the meeting were Allison, Compton, Fermi, Moore, Spedding, Wheeler and Wigner. The major topics of discussion were related to the effects of radiation on graphite and other structural materials of the pile and to setting up a metallurgical organization that will be responsible for the research and development on the preparation and fabrication of uranium metal. Doan was suggested as chairman of a temporary committee that will serve that function.

1/2/43

I have asked John Willard to take on additional responsibility as coordinator of the work on the chemical extraction processes for 94; he will thus no longer be placing his primary emphasis on the adsorption method but will be concerned with coordination of the work on the Wet Fluoride Method, the Fluoride Volatility Method, the Bismuth Phosphate Method, etc. Perlman will serve as a coordinator for plutonium purification work.

Lombard Squires and Hood Worthington have been assigned by the du Pont Company to play important liaison roles with the Metallurgical Laboratory. Squires, who is the co-author of a chemical engineering textbook and is especially well qualified, will be concerned in a liaison capacity with the chemical extraction problem, and we expect to see a lot of him. Also starting this week and early next week are two additional chemical engineers from du Pont, W. E. Kirst and Merlin D. Peterson. I knew Merlin as a fellow graduate student in nuclear chemistry at Berkeley in the middle 1930s. He received his Ph.D. in physical and nuclear chemistry from Berkeley in 1936; he has been working in du Pont's ammonia department as a research chemist.

I left Chicago for Berkeley at 6:00 p.m. on the Streamliner, "City of San Francisco." The purpose of my trip is mainly to discuss the impending move of Kennedy, Wahl, Duffield and Garner to Site Y, and to review the present and future activities of the Berkeley 94 Chemistry Group. Allison is my travelling companion this time, since he is going to Berkeley also to participate in these discussions. As usual, I am leaving the affairs of our Chicago group in Perlman's capable hands. Our move to the new chemistry building is almost completed, with only a few more loads of equipment and materials to transfer from Jones Laboratory.

Sunday, January 3, 1943

Enroute to Berkeley, I discussed the Berkeley Chemistry Group and other diverse matters with Allison. We, as well as Latimer, are concerned about what will happen to the group if Oppenheimer takes Kennedy, Wahl,

1/3/43

Duffield and Garner with him to the new laboratory being set up in New Mexico (Site Y). One of the surprises of the trip was to find on the train President Sproul of the University of California at Berkeley. We had a brief but pleasant talk; neither of us brought up the matter of my University salary, which was the subject of his letter to me last September.

Monday, January 4, 1943

When I arrived in Berkeley this morning, I checked into the Durant Hotel, which is a block off Telegraph Avenue near the campus. Unfortunately, Calvin was unable to find me lodgings at the Faculty Club. I expect to stay here until I leave for Chicago this Friday. I talked to Latimer and others associated with the 94 Chemistry group. We are going to hold a meeting tomorrow to talk about the recruitment going on for Oppenheimer's fast fission laboratory in New Mexico. Meanwhile, I am getting reacquainted with the 94 chemistry here beyond what I read in the semi-monthly reports or get second-hand from Latimer and others visiting Chicago.

I met with Edwin F. Orlemann, an instructor and an expert in inorganic chemistry in the Berkeley Chemistry Department, and invited him to join my Met Lab group. He agreed to do so. This pleased me very much because he is a good friend of mine, very competent and well qualified to play a leadership role in the difficult chemical program of extreme purification of plutonium required for its use in a nuclear weapon.

I also met with Professor E. D. Eastman of the Chemistry Department, who has joined the Latimer group to work on the plutonium purification problem. He will turn his attention to the production of plutonium metal with emphasis on devising crucible material that will minimize the introduction of light element impurities during the reduction procedure. We made plans to make a trip together to visit laboratories in the East that are concerned with uranium production to try to get some better ideas for plutonium metal production.

Tuesday, January 5, 1943

Today I met with Latimer, Allison, Kennedy, and Wahl to discuss the move of Kennedy, Wahl and others to New Mexico and the effect this will have on the 94 chemistry program here. It was agreed that those moving will be limited to Duffield, Garner, Kennedy, Morris Perlman, Prestwood and Wahl; the others will remain with Latimer's group in Berkeley. The University of California will be the prime contractor for the Manhattan Engineer District to supply personnel and operate the new laboratory at Site Y in New Mexico.

I also discussed with Kennedy his need for a large 94^{239} sample for his fission measurements, which I agreed to send him from our supply at the Met Lab, and his technique for the uniform spreading of samples on backing plates. He also needs a polonium sample for use in the preparation of a Po-Be neutron source, and I told him we plan to isolate some polonium.

I spent much of the time on the third floor of Gilman Hall talking to the fellows—learning about their progress and bringing them up to date on events at the Met Lab.

Wednesday, January 6, 1943

I met with Paul Kirk to discuss how he should proceed to obtain a release from the University of California to come with us in Chicago. He showed me the microbalances that are in construction, and we went over the plans for the new centrifuge. Kirk introduced me to Dick Rosenfels and Clifford Smith, whom he wrote to me about last month, and I made each of them an informal offer. Rosenfels received a Ph.D. from the University of California in 1933, and Smith received a B.S. a year earlier, also from U.C.

I had a long meeting with Stoughton to discuss his progress on the U^{233} program. I invited him to join my group at the Met Lab, on a

1/6/43

permanent basis, to lead the U^{233} work there; this work will be phased out at Berkeley, continued and expanded at the Met Lab. Stoughton accepted my offer and will move to Chicago within about a month.

I also met with Hamilton to discuss our arrangements for bombardments at the 60-inch cyclotron and his program to measure the physiological effects of 94 and the fission products.

Thursday, January 7, 1943

I visited the Rad Lab on the hill, which has expanded considerably since I was last there. Lawrence is now experimenting with a tank in the calutron 184-inch magnet that contains a double set of beam sources and collectors. The big news is that Groves has given the go-ahead for a plant at Oak Ridge in which there will be 500 such tanks. The plan is to stand the tanks and magnets, consisting of iron cores and coils, on end and group them into the shape of an oval, called a "racetrack." Thus there will be 48 magnets separated by gaps into which two tanks can fit snugly, giving a total of 96 calutrons. Each racetrack will stand about 15 feet high and will measure approximately 75 feet wide and 120 feet long. For ease of servicing, present plans call for mounting the sources, collectors and liner for each calutron on the tank's vacuum-tight faceplate. Stone and Webster Company has agreed to design and construct the electromagnetic plant, and Tennessee Eastman Corporation will serve as the operating contractor.

Friday, January 8, 1943

Part of my time in Berkeley has been spent in trying to recruit new members for my Met Lab team. Kirk and Stoughton, of course, have agreed to come. Orlemann, Rosenfels and Smith also are waiting for formal offers from Moulton's office. I also invited Garner and Gofman to visit our laboratory in Chicago whenever it is convenient for them. Gofman asked me if I would send him ten pounds of bombarded UNH when we complete our present

1/8/43

irradiation in St. Louis of the 300-pound batch this month, and I readily assented.

I departed Berkeley at 5:20 p.m. on the Streamliner "City of San Francisco" and will arrive in Chicago day after tomorrow.

Sunday, January 10, 1943

I arrived here in Chicago at 1:00 p.m. and found the weather clear but cold, around 30°F. I learned that there was heavy snow yesterday.

Monday, January 11, 1943

Perlman brought me up to date on laboratory activities of the last week as follows:

Thompson investigated an oxidation-reduction cycle for the Bismuth Phosphate Process using dichromate ion for oxidation, but it didn't work very well. He has found that in 20 percent UNH solution the addition of 0.36 M phosphoric acid at acidity 1 N in HNO_3 leads to the precipitation of uranyl phosphate. Following a suggestion by Kohman, Thompson corrected this by adding sulfuric acid to a concentration of 1 N. This prevents the precipitation of uranyl phosphate, presumably due to the formation of a complex ion involving uranyl ion and sulfate ion.

About 200 micrograms of the sample of plutonium isolated on December 11, 1942, were converted by Cunningham and Werner last Monday to the iodate and then converted to the nitrate by evaporations with 6 M HCl followed by evaporations with concentrated nitric acid. By using this larger amount of material, it was possible to get better descriptions of the colors of plutonium compounds and solutions, modifying those given earlier. The earlier descriptions were based on the observation of thin layers using transmitted light. The larger samples now available make it possible to observe colors by reflected light. Concentrated solutions of plutonous chloride

1/11/43

have a reddish brown color; on dilution such solutions take on a reddish tinge and on further dilution, a light yellow color. Concentrated solutions of plutonous nitrate have a dark emerald green color which upon dilution changes to a pale apple green color. Plutonous iodate is a white crystalline solid.

Then on Tuesday Cunningham and Werner added sufficient 30% H_2O_2 to some of the plutonous nitrate solution to precipitate plutonous peroxide which upon separation by centrifugation was seen to have an olive green color. When the peroxide was dissolved in nitric acid and then converted to the oxide by heating, a bright yellow color was seen in contrast to the brownish yellow that has been observed previously.

On Wednesday, Cunningham and Werner took some of their plutonous nitrate solution, evaporated it to dryness and heated it to form the oxide on a weighed platinum boat. The plutonium oxide and the boat were then weighed, both of the weighings being performed with their Salvioni balance. The oxide was then dissolved by fuming with sulfuric acid and the alpha particle disintegration rate was determined by counting an aliquot portion on our "inside" alpha chamber of calibrated 47% efficiency. This determination gave a value of 157,000 alpha disintegrations per minute per microgram of Pu^{239} , assuming the formula for the oxide is PuO_2 .

On Thursday Cunningham and Werner weighed a sample of plutonous iodate on a weighed platinum weighing boat using their Salvioni balance, then determined its alpha activity by counting an aliquot portion with our "inside" ionization chamber of 47% calibrated efficiency. They found a value of 154,000 disintegrations per minute per microgram of Pu^{239} , assuming the formula for plutonous iodate is $Pu(IO_3)_4$. Also, they determined the solubility of plutonium peroxide in 20% H_2O_2 , 1 M HNO_3 solution using their ultramicrochemical techniques; they found for the solubility, in two experiments, the value of 23 ± 9 milligrams of plutonium per liter.

The determinations of the specific activity of 94^{239} that Cunningham and Werner have made have all been done with samples weighing of the order of a few micrograms and the weighings were performed with their home-built Salvioni balance. Since sufficient

1/11/43

94^{239} is now available, they decided on Friday to make a determination using a commercial Ainsworth type FDJ microbalance. (The Kirk balance is not in good working shape yet.) Their sample of plutonous iodate was found to weigh 47.2 micrograms. By counting aliquot portions of this sample again using our "inside" ionization chamber of 47% calibrated efficiency, they found a specific activity of 94^{239} equal to 154,000 disintegrations per minute per microgram. Averaging all of the determinations to date, we now have for the specific activity of 94^{239} a value of $155,000 \pm 2,000$ alpha disintegrations per minute per microgram; this corresponds to a half-life of 21.3×10^3 years for 94^{239} . The agreement obtained for the specific activity of 94^{239} by weighing the oxide, assumed to have the formula PuO_2 , and the iodate, assumed to have the formula $\text{Pu}(\text{IO}_3)_4$, is good evidence that the lower oxidation state that we have been working with and referring to as plutonous plutonium is the +4 oxidation state.

Last week Werner worked on the various residues from the isolation of plutonium from our large St. Louis neutron bombardment (Chicago II) which ended on October 25. These are the residues and by-product solutions remaining as a result of the isolation of about 230 micrograms of plutonium nitrate in the procedure by Cunningham and Werner which was concluded on Friday, December 11.

A 97.2 gram sample of UF_6 which has been bombarded with neutrons at the St. Louis cyclotron (bombardment F-6-2, started December 22) was removed on Saturday after a total exposure of 36,000 microampere-hours.

Cefola started on Wednesday a series of experiments to determine the carrying of Pu^{+4} on UF_4 at various ratios of U^{+4} to Pu^{+4} . The aim is to establish whether, with the incorporation of the UF_4 in a lanthanum fluoride precipitate, it might be possible to carry plutonium and then remove the plutonium along with uranium from the lanthanum fluoride precipitate by oxidation to the soluble fluoride. Today he completed these carrying experiments. He finds that at a U^{+4} to Pu^{+4} ratio of 10,000:1 the plutonium is carried to the extent of 92%; at a ratio of 1,000:1 it is carried 41%; and at a ratio of

1/11/42

10:1 it is carried only 14%. This is rather surprising in view of the similarity between UF_4 and PuF_4 .

Today Koshland completed experiments on the disposal of uranium wastes. He has developed a procedure starting with neutron bombarded UNH from which 94 has been removed by precipitation with lanthanum fluoride, in which he removes the fluoride by precipitation of calcium fluoride by the addition of calcium. Uranyl peroxide can then be precipitated from acid solution in the absence of fluoride by addition of hydrogen peroxide. He finds that this process is satisfactory and recovers uranium in a compact, easily soluble form. Further experiments are needed to determine how much fission product radioactivity remains with it.

Perlman said that he received a distressing call on Tuesday from Fulbright at the St. Louis cyclotron. It seems that the day before, two of his men upset the cart that supports our boxes of UNH (the 300-pound batch, Chicago III). The box marked "B" burst open at the end farthest from the target and a small fraction of its contents spilled out onto the floor. Fulbright and his crew then built a substitute box to contain the residue and the material that could be scooped up from the floor. The dirtier stuff, about two pounds, was swept up and set aside. At the time of the accident the bombardment had gone 116,000 microampere-hours, with about 60,000 more to go because we have decided to end this bombardment at about 175,000 microampere-hours.

I met Norris W. Embry, an English major from New York University who is working for us as a laboratory assistant, and also Robert Paulsen and Valda B. Lemke who are working as laboratory helpers. Covey and his assistants have set up in our new building the equipment for recrystallizing UNH and have been busy the last week preparing UNH for the next large neutron bombardment at St. Louis.

Spof English received his Ph.D. from Berkeley last month, so today I wrote a memorandum to Moulton asking that his salary be raised to \$250 per month.

1/11/43

Don M. Yost of Northwestern University sent me a letter to let me know that he has sent a wire to Professor William G. Young of the Department of Chemistry, UCLA, offering to hire two of UCLA's graduates, John H. Sullivan and George Pimentel, for NDRC work; he also told Young he did not wish to compete with Coryell or me for these men. "As you know," he wrote in his letter to me, "the competition for men in defense projects is a thing that I frown on, and I do not wish to be guilty of the very thing of which I disapprove so heartily."

It is always a pleasure to hear from Benedetti-Pichler. Today was no exception. He replied to my letter of December 28 regarding his student Rochford, who needs help with a microbalance. He opened his letter with the following words: "Let me thank you for your very kind letter. I am like the man with the dog, who has settled down on a rainy day to spend a nice afternoon in his soft chair. The dog, just like my boy Rochford, keeps looking at him with moist brown eyes. So finally he gets his rubbers and raincoat to go for a walk."

He went on to say that Rochford will be permitted to continue "in his basement hole--provided that he won't use anything that gives the stockroom any kind of trouble. I went through his problem again on paper. I think that we will be able to cast a balance case (ourselves) of zinc, our principal trouble." He then asked if Cefola would send a piece of clear fused quartz rod and a small collection of quartz fibers, the dimensions of which he gave. Rochford, he said, will graduate in June and he might try to get him enrolled at Fordham University for thesis work under his direction.

Someone said that he saw General Groves in Ryerson Laboratory today. Probably he is here to confer with Compton about our general progress and to urge him to expedite it in every way possible.

Headline news today is of the Atlantic Ocean, where convoys are reported to have repelled 35 Nazi submarine attacks.

Tuesday, January 12, 1943

Cunningham and Werner prepared 30 micrograms of 94^{239} in the form of the nitrate for shipment to Kennedy in Berkeley, as I promised Kennedy during my visit there last week. The 94^{239} is in 100 λ of solution, which is 0.001 M in HNO_3 .

A new Research Assistant started work today in our group. He is Edward G. Bohlmann from Syracuse, New York, and I am assigning him to work with Brown and Hill on the dry fluoride method for the separation of plutonium from uranium and fission products.

Groves, Roger Williams of du Pont and Compton have concluded two days of meetings with each other. I learned that their talks centered about a chemical semiworks (pilot plant) for the recovery of 94. Du Pont has a letter contract to design and construct the semiworks, the blueprints to be approved by the Metallurgical Laboratory. Unfortunately, the du Pont engineers have decided to build the semiworks at Site X, which is far removed from Argonne Forest where we expected it to be. Williams and Groves spent most of the day convincing Compton that the choice of Site X is the correct one. As for the full-scale production plant, Groves has concluded that its location at Site X is out of the question because of the power requirements and the potential hazard to Knoxville and the surrounding towns. It now looks as if a place will be selected for it on the Columbia River in the middle of Washington State where there is lots of power and a very low population density.

Our group meeting tonight was concerned largely with my description of my visit to Berkeley and my further briefing on the progress made during my absence.

Wednesday, January 13, 1943

Today Cunningham and Werner made attempts to reduce plutonium dioxide which was on a platinum weighing boat. They attempted to reduce it with

1/13/43

hydrogen first at 400°C and then at 800°C, one-half hour at each temperature, but there was no color change from the bright yellow, and it was concluded that no reaction takes place under these conditions.

Brown and Hill have completed their measurements on the various fractions of the neutron-bombarded UF_6 sample that they distilled on December 31. They find that the elements 93 and 94 were quantitatively separated from the uranium hexafluoride distillate and also the fission activity was separated to a remarkable extent.

Willard and Koshland, working with M. D. Peterson of the Chemical Engineering section, have found that it is possible to dissolve lanthanum fluoride in a solution containing zirconium ion. A 1 N HNO_3 solution containing 100 mg per cm^3 of Zr^{+4} will dissolve a weight of lanthanum approximately equal to the weight of zirconium. This might be a useful method of dissolving the lanthanum fluoride precipitate in the Wet Fluoride Process. The lanthanum would be precipitated away from the zirconium solution after the 94 has been oxidized.

Turk tested the carrying of 94 by a preformed bismuth phosphate precipitate, that is, a precipitate that is formed upon the addition of bismuth solution to solution of phosphoric acid that contains 94 tracer. He finds that the 94 is carried to the extent of 98%, indicating that this will be very satisfactory in the Bismuth Phosphate Process.

We have had continued cold weather since our heavy snow last Saturday, and the sidewalks and ground are quite icy. Indeed, today is the coldest day of the new year, $-7^{\circ}F$ early this morning.

I wrote to Kennedy that we are sending him more than 25 micrograms of pure 94^{239} in 0.1 cc volume, approximately 0.001 N in HNO_3 , prepared by Cunningham. This sample shows the highest specific activity of any sample we have prepared, namely, 155,000 disintegrations per minute per microgram (corresponding to 21,300 years half-life). Cunningham, I said, would like to learn his techniques for spreading samples uniformly, both on ordinary backings and on the extremely thin backings. I mentioned that the

1/13/43

polonium purification work should get under way by this weekend, and that I will keep him informed.

Next I sent a letter to Stoughton, saying that he will soon receive an offer from Moulton, our personnel director here. I assured him that Helen is searching for a furnished apartment for him. I wrote the same sort of letter to Kirk, but in addition said that Mrs. Allison called the other day with information about an unfurnished apartment that will be available soon. Helen went by to inspect the apartment, and I enclosed her description of it in my letter.

The final letter today was sent to Friedlander at the University of Idaho in Moscow, Idaho; it read as follows: "I was certainly glad to hear from you, and I am sorry that I have delayed so long in answering your letter. The reason I have delayed is that I have not yet had success in arranging for you to come with us. I have not heard of any developments, positive or negative in the matter of your clearance, but I have heard that they are still working on it. Matters of this kind seem to be shrouded in mystery until the final decision is made, and it seems impossible to obtain any information before that time. I intend to continue working on it because I am still very anxious that you come with us, if you are still interested in doing so.

"Please keep writing to me to let me know how you are getting along, and I will probably do better in answering from now on. My best regards to you and Mrs. Friedlander."

Just before quitting time, I was in the lab chatting with Cunningham when my secretary, Edrey Smith, came in to inform me that Compton phoned that he was leaving his office in Eckhart Hall and going home, but that he would like to stop by to see me on the way. When he arrived at my office, he set down his brief case and I invited him to remove his overcoat, hat and muffler and take a chair. After we exchanged a few pleasantries, he said that he had something to talk over, which had been on his mind for some time, and this seemed like the right opportunity. Then he told me he is asking James Franck to take over Allison's job as head of all chemistry at the Lab. Allison, it seems, has more than he can do and wants to be

1/13/43

relieved so he won't have to neglect his duties as the Lab's Associate Director. It is Compton's opinion that Franck is the best qualified scientist in the whole United States to assume this position and that we are most fortunate that he is already here on the campus and is willing to accept the appointment. Although I expressed some reservations, I made no objection.

After our talk, Compton and I walked together along Fifty-sixth Street to Woodlawn Avenue, where we both have our homes. As we walked along Fifty-sixth Street engaged in an amiable conversation, Compton was in mid-sentence when he slipped on the ice and took a tumble to the sidewalk. To my amazement, he picked himself up without losing his grip on the briefcase or without any regard for his undignified sprawl, completing the sentence as though never interrupted!

Thursday, January 14, 1943

The meeting of the Chemistry Division, held in Room 209, Eckhart Hall, from 9:00-10:00 a.m. this morning, was devoted to a survey of the methods being developed for the separation of 94 from uranium and fission products. Cooper and I summarized each of the numerous considerations involved for the four processes—Dry Fluoride Process, Wet Fluoride Process, Peroxide Process, Ether Extraction Process—giving a numerical rating value to each, as in the following table:

	<u>Dry HF</u>	<u>Wet HF</u>	<u>Peroxide</u>	<u>Ether</u>
	<u>Process</u>	<u>Process</u>	<u>Process</u>	<u>Extraction</u>
Primary				
<u>Considerations</u>				
1) Yield, dependability and consistency	95	90	60	75
2) Feasibility under radiation, chem. stability and heat removal	75	90	95	25

	<u>Dry HF</u> <u>Process</u>	<u>Wet HF</u> <u>Process</u>	<u>Peroxide</u> <u>Process</u>	<u>Ether</u> <u>Extraction</u>
Primary <u>Considerations</u> (cont.)				
3) Freedom from main- tenance, corrosion of moving parts, untried types of equipment	50	85	80	75
4) Ease of control, pH, interfaces, temp., comparative rates of flow	80	95	85	70
5) Availability of raw materials	85	95	90	100
Secondary <u>Considerations</u>				
6) Ease of storage of wastes, U, volume and activity	95	80	75	95
7) Availability of processed U, low activity making it easy to process chemically	100	70	70	95
8) Quantity and quality of isolated fission activity	75	80	85	95
9) Quantity of equipment required	95	85	80	80
10) Quality of product (free from activity and small bulk)	85	85	80	85

1/14/43

Today Hill distilled the 97.2-gram sample of UF_6 (F-6-2) whose bombardment with neutrons at St. Louis was terminated last Saturday. The UF_6 was distilled from its container into a Monel trap, and the plan is to determine how much of the 94 and 93 and fission product gamma activity distilled with the UF_6 .

James has the measles and will not be in for several days. Allison is ill too; he has pneumonia.

Perlman sent a memorandum to D. P. Rudolph in Met Lab procurement, stating that Doan has authorized the release of 10 pounds of uranium metal for the use of Professor Eastman in Berkeley and that he will take custody of the material from Rudolph and handle the delivery to Eastman.

Harrison Brown is at Niagara Falls today. He is visiting the Hooker Electrochemical Company to inspect the production facilities in connection with our interest in developing a means of producing fluorine in large enough quantities for use in our dry fluoride separation process. He plans to leave Buffalo tonight and will arrive in Chicago tomorrow.

Last Monday Doan issued a memorandum that all non-academic employees (those hired for a specific number of hours per week or month) punch a time clock to be installed in Eckhart Hall. This presents a problem to those working here in the New Chemistry Building, so today Covey circulated a petition suggesting that the guard here let non-academic personnel sign in and out instead. He made the point that at least 15 minutes will be lost morning and evening going to Eckhart punching the clock, whereas the loss of wages and work doesn't justify it, and especially because a patriotic incentive to work overtime would be stifled.

The Soviets claim a 50-mile advance in the Caucasus, and the Nazis concede their main line is broken.

Friday, January 15, 1943

I have asked Turk to continue for a while his work with Thompson on the Bismuth Phosphate Method in view of the promise of this method. During the last week Thompson and Turk have investigated the best conditions for the precipitation of bismuth phosphate from 20% UNH solutions which are 1 N in H_2SO_4 in order to prevent the precipitation of uranyl phosphate. They find that the H_3PO_4 concentration can probably be reduced well below 0.36 M without appreciable reduction in the recovery of tracer 94. At $95^\circ C$ the precipitation of bismuth phosphate seems to be complete in about five minutes with a 98% recovery of 94. The acid concentration appears to be the most critical variable and a maximum allowable concentration of 1.25 N H_2SO_4 is indicated. Bismuth phosphate is only partially precipitated in one hour at $25^\circ C$, but at $60^\circ C$ complete precipitation takes place in one hour, and the recovery of 94 is complete. It is probable that the amount of bismuth carrier can be reduced to 10 mg per 10 cc of solution without appreciable loss of 94. This is in contrast to the results in the presence of nitric acid where a yield of only 75 percent of the 94 is obtained with 10 mg of bismuth per 10 cc. The UNH concentration should not be increased above 22 percent or losses of 94 may be appreciable.

Cunningham and Werner attempted to convert PuO_2 to volatile $PuCl_4$ by treatment with Cl_2 and CCl_4 . There was no color change, and the product was not soluble in water. Apparently no $PuCl_4$ was formed.

Today Brown and Hill fluorinated a sample of bismuth phosphate containing 94 tracer, prepared by Turk, in order to ascertain whether the 94 can be removed. The sample was fluorinated at $600^\circ C$ for one-half hour, and analysis shows that more than 99% of the 94 volatilizes from the bismuth phosphate precipitate. This indicates that the use of fluorination might be a feasible method of removing 94 from a bismuth phosphate precipitate in connection with the Bismuth Phosphate Method for separating 94.

1/15/43

A letter arrived from Eastman in Berkeley. J. Arthur Campbell, he said, has successfully repeated the plating experiments (the electrolytic deposition of aluminum on uranium metal) he was conducting at Latimer's suggestion. They are sending me the latest sample for the inspection of the metallurgists here, along with a report on their procedure. He said that, in addition to the uranium metal we are shipping him, he would like to receive some thoria for use and study as refractory material and some very pure graphite in blocks to be used for making crucibles and boats.

I also received a letter from Fulbright in St. Louis reporting the January 4 accident to our 300-pound UNH irradiation. The present bombardment has reached 145,000 microampere hours. When the irradiation is terminated, we plan to extract ten pounds of the irradiated UNH from one of the boxes and ship it express to Gofman in Berkeley.

Saturday, January 16, 1943

Jaffey performed some experiments with samples of pure 94 dioxide, furnished by Cunningham and Werner, designed to establish whether a volatile 94 chloride can be produced. Using samples weighing in the range of 0.1-0.2 microgram, he passed a mixture of chlorine and carbon tetrachloride over the 94 oxide at temperatures of 425°C, 600°C and 710°C. He finds zero volatility at 425°C, about 6.5% volatilized at 600°C, and 98.5% volatilized at 710°C. These experiments indicate a volatile chloride but do not give any information as to its oxidation state.

In a meeting with du Pont representatives today I indicated that I would like to get 100 grams of 94 from Site X as soon as possible for purification and separation studies, which I think came as a considerable jolt to them. They said my demand was unreasonable because they are planning to operate the pile there at 500 kilowatts; it would cause delay because this would require emphasis on production rather than on a semiworks operation. I then agreed I would insist on the 100 grams only if absolutely necessary.

1/16/42

Kirk and I had an exchange of telegrams to confirm that he now has an apartment reserved for him and his family when they arrive in Chicago. I also received a letter from Ed Orlemann in Berkeley. He has made arrangements to leave Berkeley on January 31 and plans to arrive in Chicago to join our group about February 6 or 7 after getting his wife and children temporarily settled in St. Paul. Both Kirk and Orlemann are being hired as Research Associates.

I sent "Plans for Chemical Extraction of 49 from Argonne Material" to Stearns and Cooper. I emphasize that the main reason for running the Argonne pile is to produce 49 for use in investigations concerned with the purification of 49. I describe the chemical facilities that would be required to extract the 49 from the neutron-irradiated lumps of uranium. The major points set forth in the memorandum are (1) an amount of 94^{239} as low as 10-30 milligrams would be extremely useful, (2) it seems certain that this amount can be extracted with ordinary laboratory equipment from uranium containing 1 mg per lump (7-10 pounds), and (3) it is likely that more than this amount can be extracted with such equipment. This memorandum is the first in a series with a new numbering system for my memoranda; it has the designation MUC-GTS No. 1.

The members of the four groups of the Chemistry Division have essentially completed their move from Jones and Kent Laboratories to the New Chemistry Building (Figure 26). The brick building is on the east side of Ingleside Avenue (5625 Ingleside Avenue) extending from 56th Street about half a block south, one story high with an attic and a concrete floor. My group working on Chemistry of Final Products is located in the north end of the building, generally in Rooms 1 to 16, inclusive. I have my office in Room 15, which I share with Perlman. Burton's group working on Radiation Chemistry is located in the south end, Rooms 33 to 38, inclusive, with his office in Room 33. Coryell's group working on Chemistry of the Fission Products is located in Rooms 25 to 32, inclusive, with his office in Room 25. Boyd's group working on Analytical Chemistry and Control is located in Rooms 39 to 43, inclusive, with his office in Room 32; part of Boyd's program, including his work on adsorption methods of separation, remains in Kent Chemical Laboratory. The middle rooms,

1/16/43

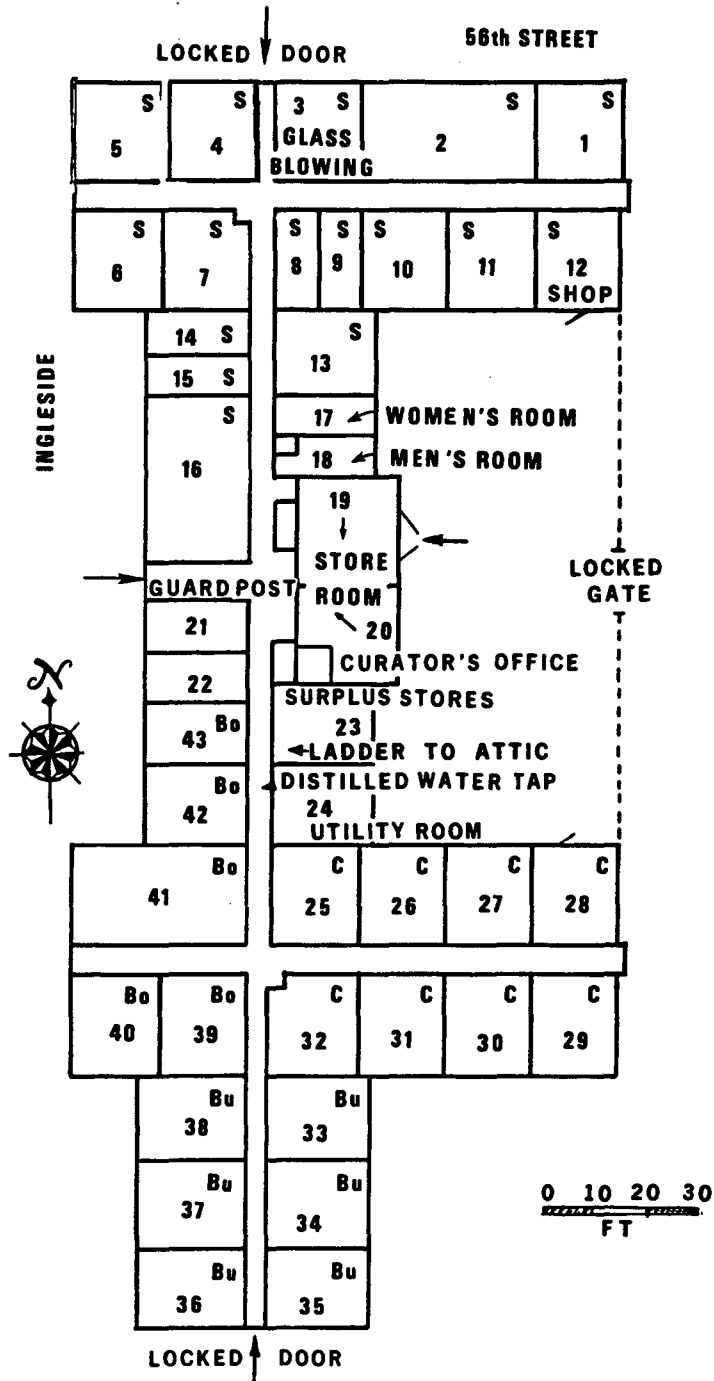

Fig. 26 Floor plan of New Chemistry Building, 5625 Ingleside Avenue. Rooms occupied by Seaborg's group designated by S, Boyd's group by BO, Coryell's group by C and Burton's group by Bu. (XBL 758-3807)

1/16/43

numbers 19 to 24, inclusive, are devoted to office space, storeroom space, utilities and service space, etc. Thus Room 22 will serve as Franck's office; Room 21 as the office for Franck's secretary and for Spedding during his visits; Rooms 19 and 20 as storerooms where Howard W. Lange, the Chemistry Division's curator, and Fred D. Johnson, assistant curator, will make their headquarters; Room 23 as space for surplus stores and equipment, with a ladder to the attic which houses the distilled water still and provides additional storage space; and Room 24 as the location of a compressor to supply compressed air which is piped into each laboratory and also of a 300-gallon storage tank for distilled water. The building is heated with steam from the central University of Chicago steam plants.

I believe it is worthwhile to describe in more detail the distribution of the members of my group in our rooms: Room 1, Magel, with furnaces and equipment suitable for his metal production program. Room 2, Brown, Hill, Bohlman and Jaffey, with special fume hoods for work on the fluoride and chloride volatility methods. Room 3 is the Chemistry Division's Glassblowing Room, where our capable but somewhat temperamental glassblower, Julius (Osty) Ostapowicz, is located. Room 4, Thompson and a number of new additions to our group whom we expect soon, a center for work on precipitation-type extraction methods. Room 5, Kohman, James and Koshland, another room for work on extraction methods. Room 6, Perlman and Knox, a room for work on 94 purification as well as extraction. Room 7, Jarrett and others to come, with our beta particle counters and electroscopes. Room 8, the microchemists' balance room. Room 9, Cunningham's office and laboratory. Room 10, Cunningham, Werner and Cefola, for ultramicrochemical work. Room 11, Willard and Turk, for work on adsorption and other methods of extraction. Room 12 is the Chemistry Division's shop where Covey and his people make their headquarters (Figures 27 and 28). Room 13, reserved for Kirk and his people to work on our 94 metal production program on the ultramicroscale; in the meantime it will be used by members of English's group for work on radiation detection instrumentation. Room 14, secretarial office for Edrey Smith and her assistants to come. Room 15, my office, shared with Perlman when he is not working in Room 6. Room 16, English, Ghiorso and Crawford, with our alpha particle and fission counters and FP-54 ionization chamber.

1/16/43

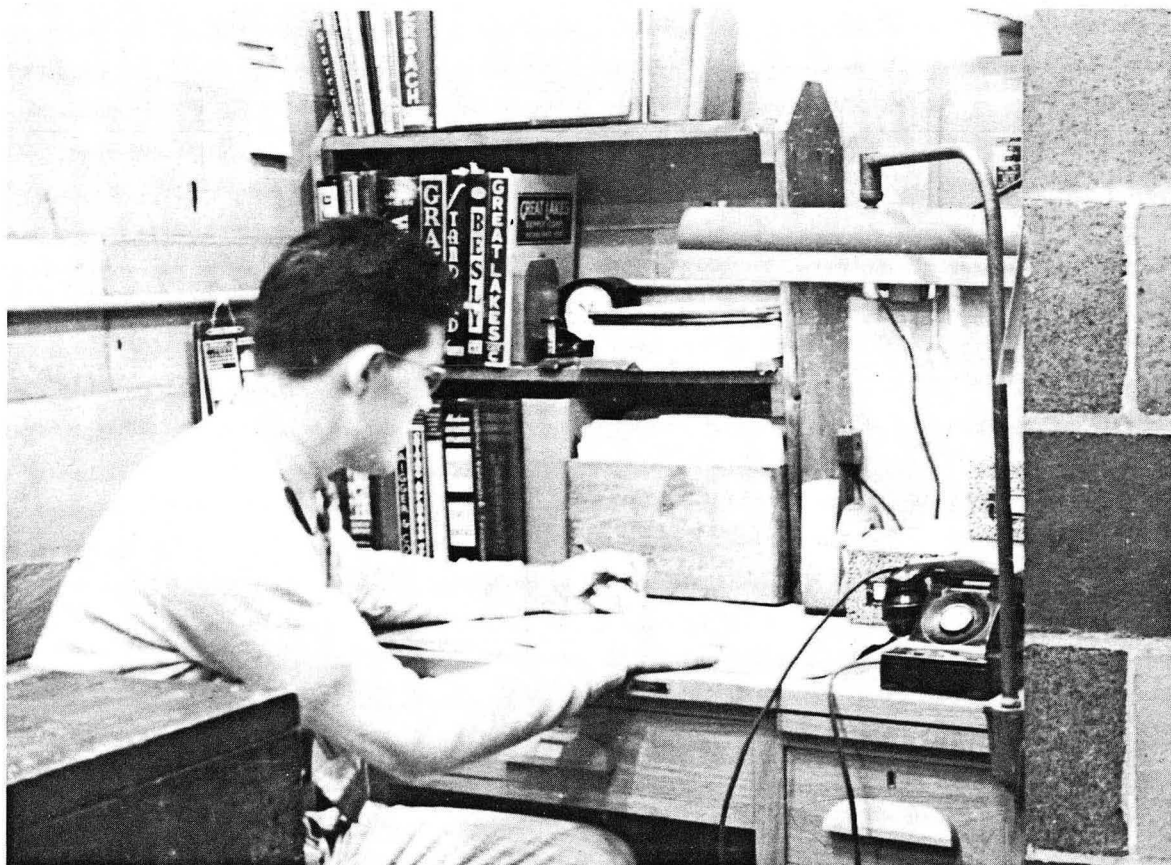

*Fig. 27 Elwin Covey at his desk, northwest corner of Room 12 (shop),
New Chemistry Building, early 1943. (XBB 768-7451)*

1/16/43



Fig. 28 Work bench along west wall of Room 12 (shop) New Chemistry Building, early 1943. (XBB 768-7450)

1/16/43

Our people have been busy, since last month, planning and arranging for the building of extra laboratory benches, vacuum racks, supporting equipment, placing of desks, bookshelves, etc. This, of course, will be a continuing process even after we get initially settled in our new quarters.

Sunday, January 17, 1943

The Soviets announced that they have begun "an offensive of annihilation against the German siege force encircled at Stalingrad after rejection of a Red army ultimatum which gave the remaining 80,000 enemy troops their choice between surrender and death."

Monday, January 18, 1943

Compton was in Wilmington on Saturday conferring with the du Pont people. They informed him that they expect the Metallurgical Laboratory to operate the pile and chemical semiworks to be erected at Site X. Compton told them it would be unthinkable. According to him, du Pont will be designing and building the facilities, du Pont decided to place them at Site X contrary to his wishes, so why shouldn't du Pont be responsible for the operations? Indeed, how could the University justify taking on the role of an industrial operator? Du Pont argued that their company doesn't have technically qualified personnel--they were hoping that their men could get on-the-job training at Site X and thus be competent to operate the production plant in Washington State. Compton did not budge from his position, so they reached an impasse.

Stearns and others are now referring to the project at Argonne Forest as the Argonne Laboratory. The immediate program now calls for the building of a 25 to 50 kw pile by April 1 of this year. This pile will be operated for about 60 days to provide 10 to 30 milligrams of 94^{239} , which will be used in those investigations concerned with the separation and

1/18/43

purification of 94 by ordinary laboratory methods. The most desirable concentration seems to be of the order of one milligram of 94 in ten pounds of uranium. In the future the pile may be used (1) as a radiation unit for research in nuclear physics and (2) for training scientific and technical personnel who will operate future piles.

The pile will be constructed of about 45 tons of uranium metal and 450 tons of graphite. A concrete shield of sufficient thickness, five to seven feet, will surround the pile to permit continued use of the laboratory building. The first graphite was received January 5 and machining of this material began last Friday. Fifteen men who live near the area are being used both for graphite processing and for building maintenance. Five trucks and 36 skids have been made available for this work by Captain Peterson. A one-ton elevator is scheduled to arrive February 2. All graphite is supposed to be delivered by February, and the uranium metal is due on the premises by March 15. Two one-half gram Ra-Be sources and 200 square feet of thin cadmium sheets were made available by Zinn. The first testing of the graphite should start in a few days. Everyone agrees that to complete the pile by April 1, it will be necessary to run a double shift on material processing and testing.

As for scientific personnel to staff the Argonne Laboratory, four of us on the campus have been selected as Division leaders: Whitaker for Physics, Cooper for Chemical Engineering, Cantril for Health and me for Chemistry. Those chosen as Group Leaders in the Physics Division are as follows: Haydn Jones, Technology; Volney Wilson, Instrumentation; D. K. Froman, Materials Testing and Henry W. Newson, Construction of Pile.

The RAF (Royal Air Force of Great Britain) bombed Berlin last night and set many fires. The German air force, meanwhile, struck twice at London.

Tuesday, January 19, 1943

In response to a wire from Garner in Berkeley, I arranged to airmail to him tonight 50 grams of lanthanum nitrate, notifying him by overnight telegram that I have done so.

1/19/43

An expert on radiation health problems has started on the Metallurgical Project. He is Herbert M. Parker, who got his M.Sc. from Manchester University in 1931 and worked as a physicist at the Holt Radium Institute in Manchester, England, and the Swedish Hospital in Seattle before coming to us. He has been assigned to the Health Group. Our new finance officer in the Administration Division is William J. Vatter, who has an M.B.A. from the University of Chicago.

The report covering the work of my Chicago Group C-V and Latimer's University of California Group for the period January 1-15, 1943, entitled "Chemistry of 94" (No. CN-419), is ready for issuance. I will describe its contents in some detail even though I have already covered many of the items in my descriptions of experiments of members of my group. S. G. Thompson and E. H. Turk, reporting on the use of bismuth phosphate for extraction of 94 from uranium, find it desirable to use sulfuric acid rather than nitric acid to adjust the acid concentration in order to prevent the precipitation of uranyl phosphate. Sulfuric acid also increases the rate of precipitation of bismuth phosphate and decreases the amount of bismuth carrier required. Experiments have been carried out to investigate the following variables affecting precipitation of bismuth phosphate and its carrying power for 94: H_3PO_4 concentration; time and temperature required for precipitation; maximum UNH concentration. Willard, Kohman, Peterson and Koshland, reporting on their study of the problems in transferring the Wet Fluoride Method from a laboratory scale to an engineering scale, describe their investigations of the means of recovering uranium and disposing of fission products and fluoride in the waste liquor. Also reported are preliminary experiments by Kohman which show that treating the fluoride precipitates directly with ammonium oxalate can extract 97% of the 94.

Willard, Peterson and Koshland report that a concentrated solution of zirconyl ion dissolves the lanthanum fluoride precipitate. Willard has tested a number of reagents to determine their ability to precipitate the uranium and fission products from the waste liquor, such as NaOH and $CaCO_3$, and finds none capable of effecting good separation of fission activity from the uranium, indicating that it probably will be necessary to precipitate both the uranium and fission products with alkali and draw off

1/19/43

the supernatant for evaporation. Working on the same problem, Koshland finds that by first removing the fluoride by precipitation with calcium ion, the uranium can be precipitated as the peroxide; further work is necessary to determine how much fission activity is carried with the uranium. Brown and Hill, studying volatility methods for separating 94, report that a stream of fluorine successfully volatilizes 94 from a lanthanum fluoride precipitate containing high 94 concentrations. In another experiment a sample of UF_6 , bombarded at St. Louis, has been distilled and elements 93 and 94 were quantitatively separated; likewise the UF_6 can be well purified from the fission products. These observations are of interest from the point of view of a UF_6 -fueled pile.

Cunningham and Werner describe additional determinations of the specific activity of 94^{239} made by weighing PuO_2 and $Pu(IO_3)_4$ samples on a Salvioni or Ainsworth Type FDJ microbalance, then dissolving the compounds and counting aliquots. All values obtained in these and previous determinations are summarized and the average value found to be $155,000 \pm 2,000$ disintegrations/minute/microgram; on this basis the half-life of 94^{239} is calculated to be 21.3×10^3 years. Cunningham and Werner also have determined that plutonium fluoride can be successfully metathesized to the hydroxide by treatment with sodium hydroxide; 100 micrograms of pure plutonium fluoride were used in this test. The solubility of plutonium peroxide in 20% H_2O_2 and 1 M in HNO_3 has been measured and found to be 23 ± 9 mg Pu/liter. The procedures are described which were followed by Cunningham and Werner in preparing 220 micrograms of pure plutonium nitrate from 4 liters of solution obtained by ether extraction (2 cycles) of approximately 300 pounds of bombarded UNH from the second St. Louis cyclotron neutron bombardment (Chicago II, September 5-October 25, 1942). The isolation was carried out during November and December 1942. Cefola has tested the carrying power of UF_4 for plutonium and finds that it does not carry plutonium quantitatively at ratios of U:Pu of 1,000:1 or less, thus indicating that plutonium probably does not form an isomorphous precipitate with UF_4 .

In Latimer's part of the report, Connick, Duffield, Garner, Gofman, Prestwood and Wahl report on "Acetate Extraction and Decontamination Process"; they describe a revision of this process in which the plutonium is kept in its reduced state in the solution obtained by dissolving the

1/19/43

pile uranium in nitric acid—the uranium is precipitated as sodium uranyl acetate, leaving plutonium in solution, leading to a much smaller precipitate when oxidized plutonium is precipitated with sodium uranyl acetate in the second step. Hamaker and Sheline also report on "Microgram Scale Investigation of the Chemistry of Pu."

This report also includes descriptions of the effect of radiation on separations processes by members of Burton's group, of the high temperature diffusion of 94 and 93 from metallic uranium by members of Spedding's group at Ames, and a report on conversion electrons from 93^{239} and Pa^{233} by Mitchell of Indiana University.

At our group meeting tonight there was much discussion of the new leadership in the Chemistry Division and the organization to carry on the extraction of 94 at Argonne. The Argonne operation will require the ordering of much equipment.

It turned very cold today and the temperature was about -5° as Ghiorso and I walked home across the windy Midway after our meeting.

News from the Soviet war front is good. The unsuccessful siege of Leningrad is over after 17 months.

Wednesday, January 20, 1943

Cefola performed today some ultramicrochemical experiments to see whether 94 is carried by bismuth phosphate from 20% UNH, 1 N H_2SO_4 solution, 25 mg Bi^{+3} per 10 ml, at the high ratios of 94 to bismuth that would exist in an actual extraction plant. He performed experiments at a ratio of 94 to bismuth of 1:25 and finds that the 94^{239} is carried to the extent of 88%.

Stoughton informed me by letter from Berkeley that he has received his formal offer of employment from Moulton. He is planning to leave Berkeley February 5 and arrive here two days later. He wanted to leave February 1 but couldn't get Streamliner reservations. He also wrote that Gofman and Garner are coming at the same time for a visit.

1/20/43

The report "U²³³ Production and Extraction" for the month ending January 15, 1943, has been issued with the report number CC-426. In this report I have written a section entitled "Production of Experimental Amounts of U²³³ in Conjunction with Intermediate Power Chain-Reacting Structures" in which I describe procedures for the production of U²³³ by irradiating thorium in conjunction with a chain-reacting pile. I describe methods of extracting the intermediate Pa²³³, separating it from uranium, and then allowing it to decay in order to form pure U²³³ daughter; this method of isolation of U²³³ gets around the problem of its dilution with any initial uranium impurity that is present in the neutron-irradiated thorium. I describe volatility methods using the volatile fluoride of Pa²³³ and also aqueous chemical methods for isolating the Pa²³³. The method I describe is for the first production of pure U²³³ in small amounts in conjunction with the piles that the Metallurgical Project has under consideration. In the ultimate production units where large amounts of U²³³ would be produced, the procedure may be to use uranium-free thorium and to extract the U²³³ itself rather than the Pa²³³ intermediate from the thorium.

Last night the temperature fell to 10° below zero.

Thursday, January 21, 1943

Continuing his experiments of yesterday, Cefola tested the carrying of 94²³⁹ by bismuth phosphate at a ratio of 94 to bismuth of 1:100. He finds that the 94 is carried to the extent of 95% under the standard conditions of precipitation from 20% UNH and 1 N H₂SO₄ solution.

I went to the new Argonne Laboratory and attended a meeting there with Whitaker, Compton and others. It was agreed that the first 100 milligrams of 94²³⁹ produced in Pile II at this site, which is supposed to go critical April 1, to be separated in Argonne's new chemical building, will go to the chemists. Fermi wants the second batch of 10 milligrams for use in his research. Compton mentioned that Pile III, to be erected

1/21/43

at Site X, will have a normal power of 30 kw, although it will be capable of reaching 100 kw when and if necessary.

They asked me if I am still interested in irradiating some thorium in the pile to produce U^{233} , and I replied there isn't sufficient time to prepare the extraction equipment. I suggested that the chemical extraction plant for 94^{239} at Argonne might occupy a building 20 feet x 80 feet in area including a chemistry laboratory and a counter room each 20 feet x 20 feet.

General Groves showed up at the Met Lab again today. Oppenheimer was here too; as far as I know, he spent most of the day with Manley. We now have some idea as to the amounts of 94 that will be required by the fast-fission laboratory. The day on which there is sufficient material to assemble the first 94^{239} bomb is called M Day. Oppenheimer and his group will need 50 grams of pure metal two months before M Day, three to five grams of pure compound six months before M Day, and 10-20 grams of compound, not necessarily pure, nine months before M Day.

I sent a memorandum to Moulton giving some information he needs about Rosenfels and Smith, whom I interviewed on my recent trip to Berkeley.

Gofman sent me a wire from Berkeley with the following message:
"EXTREMELY URGENT NEED FOR THE PROMISED TEN POUNDS BOMBARDED NITRATE WIRE WHEN AND HOW WILL SHIP SAME."

A report, entitled "Special Chemistry of 94," for the month ending January 15, 1943, and with the report number CN and CF-427, has been issued. This is part of a regular series that will be issued concerning special problems in the chemistry of 94 and due to their sensitive nature these reports have an extra security classification. In this report Perlman has a section on "A Possible Slow Neutron Chain Reaction During the Extraction of 94^{239} " in which he describes, as he has in earlier reports, the precautions that must be taken in order to insure that an amount of 94^{239} as large as a critical mass never accumulates during the chemical isolation procedure. In another section entitled "Precipitation of Plutonium Peroxide in the Purification of Plutonium," Cunningham and

1/21/43

Werner describe a method where after isolation by the Wet Fluoride Method from the uranium and fission products the final plutonium can be obtained in pure form by precipitation as the insoluble peroxide from acid solution. In another section of the report entitled "Suggested Methods for the Production of Highly Pure Plutonium Metal," Magel and Brown describe methods of isolating plutonium in relatively pure form through the use of fluorine and hydrofluoric acid to produce PuF_4 . They point out that in order to eliminate the light element impurities, particularly fluorine, PuF_4 might be converted to a heavy halide of plutonium and then be reduced to the plutonium metal by using a heavy base metal as reductant. Thus bromine or iodine might be substituted for the fluorine, and barium might be the reducing agent. The reduction reaction would have to be carried out in a special moisture-free and oxygen-free chamber. They also point out that another method for producing plutonium metal free of light elements might be through the thermal decomposition of gaseous plutonium iodide. This section also discusses electrolytic methods for the production of plutonium metal, and various types of refractories that might be used in which to carry out the thermal reduction of plutonium halide to the metal.

War news from the various fronts today report British advances in Libya and naval successes in the Mediterranean, new Russian gains, American advances in New Guinea and the Solomons and air attacks on Japanese positions in Burma.

Friday, January 22, 1943

Completing his work started on January 8, Werner has isolated an additional approximately 50 micrograms from the residues and by-product solutions produced by Cunningham and Werner during their work-up of the St. Louis neutron bombardment, Chicago II. Using this material, Werner has tested the carrying of 94 by bismuth phosphate, at a ratio of 94 to bismuth of 1:25, from a solution of 20% UNH and 1 N H_2SO_4 , 25 mg of bismuth per 10 cc; in other words at the standard conditions. The precipitation took place at 95°C. He finds that about 75% of the 94 is carried under these conditions. It appears that conditions can be

1/22/43

established that will allow satisfactory carrying of 94 by bismuth phosphate when it is precipitated from a solution of 20% UNH which is 1 N in H_2SO_4 .

Hamilton sent a memorandum from Berkeley dated January 20, 1943, "Some Comments Concerning the Problem of Inhalation of Short-Lived and Long-Lived Active Deposits Arising from the Short-Lived Radioactive Isotopes of Krypton and Xenon," to Stone in the Health Group. I received a copy inviting my comments. The gist of the memorandum is that there are nine decay chains that involve the growth of short-lived active deposits from krypton and xenon. There are 15 members arising from these nine chains whose half-lives range from 40 seconds to 8.5 hours. The average half-life of this group is 1.5 hours and the mean life approximately two hours. This group represents almost a third of the total number of radioactive atoms produced by uranium fission. From these 15 short-lived radioactive isotopes there also arise the long-lived isotopes of strontium and yttrium, the barium-lanthanum pair, and possibly zirconium. The barium has a half-life of 300 hours and is accompanied by the 44-hour lanthanum daughter. The other three possess half-lives which are approximately two months in length.

Hamilton then made a round approximation of the effects of inhalation of this complex mixture, assuming that all of the inhaled active deposits remain trapped in the lung tissue. He estimates that during a 24-hour day, an individual would receive 0.1 roentgen to his lung tissue, which is a safe daily dose, if the air about him contains 1.25×10^{-3} microcurie of active deposits per liter of air.

Willard and I attended the latter part of today's Technical Council meeting, the other participants being Boyd, Compton, Cooper, Doan, Fermi, Greenewalt, Hilberry, Mulliken, Ohlinger, Captain Peterson, Spedding, Stone, Wigner and Young. Greenewalt reviewed the relative merits of a water-cooled and a helium-cooled pile. In summary he listed on the board all the factors along with corresponding plus signs where relevant.

"Could piles of each kind be made?" inquired Spedding. Greenewalt replied: "Very many experiments are needed for either system. Are there enough brains here to do this for both piles? I think not. The plant

1/22/43

will surely not work right at first—we only hope that no fatal point will fail to be anticipated. Both types of pile must still be studied for some time, although we hope not for long."

Compton explained that Greenewalt did not mean "insuperable" when he used the word "fatal," but only too much delay would ensue. Wigner, who is the champion of the water-cooled system, remarked that a consideration of two plants helps broaden the viewpoint on both, and Stone said that a water-cooled plant would be definitely easier to control from the viewpoint of health hazards.

Our discussion then turned to adsorption methods of 94 extraction using organic resins which have attracted much attention recently in view of some encouraging results obtained by Boyd and members of his group. Here are the minutes of what transpired:

Boyd: Recently reached belief adsorption methods for separating product feasible using principle of selective adsorption in columns. Laboratory columns 1-1-1/2 cm diameter, 15 cm long showed good separation efficiency up to 10% nitrate concentration. Leads to nearly complete separation of uranium fission activity, and plutonium by several steps of washing and use of three columns. West Stands experiment done on column with 80 times preceding cross section, results nearly the same. No troubles with channeling.

Cooper: Much intrigued with approach. Disadvantages: (1) large amounts of acid needed, several times amount of waste disposal that occur in other separation methods, (2) range of types of acid may complicate engineering somewhat. Otherwise, looks very promising.

Seaborg: The method looks much more complicated than Willard's procedure with inorganic adsorbent. Willard and Turk sought a two-step procedure, to remove 49, then fission products, separately. Studied first with tracer amounts, then with micro amounts.

Willard: Used column packed with diatomaceous earth. Used 10% uranyl nitrate solutions. Find about 10% of gamma ray activity adsorbed (zirconium, columbium mainly), 100% 49 adsorbed at first, then gradually falls to 85%; 3% of uranium adsorbed. Using 5 or 6 pounds nitrate to 1 pound packing. By passing a small amount of HNO_3 through, most of 94 is washed through, with hardly any of gamma ray activity. Thus get 92% of total 94 with less than 1% of fission products and 2% of uranium (this can

1/22/43

be got out by using a preceding water wash); the 94 is in essentially 10% of the original volume. This process keeps more fission activity with the uranium than Boyd's process.

Spedding: Suggest try out both methods on larger scale.

Compton: Asks Boyd how larger concentration of 94 would work.

Boyd: Tests of UX_1 indicate results same at higher concentrations. Work on other substances at higher concentrations in relation to Langmuir theory supports this. Also Willard's results at higher concentrations encourage belief in this.

Compton: What program?

Cooper: Should study different resins; out of hundreds, one might be tailor-made to be more specific for 94.

Compton; Cooper: Advantages of system, absence of moving parts.

Boyd: Hard to get cooperation of companies on synthetic resins.

Cooper: Greenewalt believes the Wilmington experimental station has more experience on synthetic resins than anyone else and will cooperate if asked.

Stone: Effects of radiation on resin?

Boyd: Tests at Notre Dame satisfactory, although on dry material.

Boyd: Resin can be used with HF; only concentrated HNO_3 attacks it. Franck suggests these resins self-healing because of double bonds.

Saturday, January 23, 1943

Today Thompson tested the use of $S_2O_8^{-2}$ in the presence of silver ion as an oxidizing agent for an oxidation-reduction cycle in the Bismuth Phosphate Method. He precipitated the bismuth phosphate containing 94 tracer in the usual way. In this experiment he used UNH containing 94^{239} and fission products from the St. Louis neutron bombardment that ended on October 25, 1942 (Chicago II). The bismuth phosphate precipitate was dissolved in 10 N HNO_3 and the oxidation carried out in this solution. He finds that after this oxidation and separation of bismuth phosphate, reduction of the filtrate with SO_2 and a subsequent lanthanum fluoride precipitation, the yield of 94^{239} is only about 50%, indicating a poor

1/23/43

yield in such an oxidation-reduction cycle. This indicates that either 94 is not oxidized quantitatively in HNO_3 solutions containing H_3PO_4 under the conditions used or that 94 in the oxidized state is carried by bismuth phosphate. It will be necessary to try other oxidizing agents and other conditions because the success of the bismuth phosphate process probably depends on perfecting an oxidation-reduction cycle.

Today we welcomed a new Research Associate into our group. He is Norman R. Davidson, an instructor from the Illinois Institute of Technology. For the past few months he has been working on the campus with H. I. Schlesinger on volatile uranium compounds. Davidson received a B.Sc. from Oxford in 1939 and a Ph.D. in chemistry from the University of Chicago in 1941. As his immediate assignment, he will work on the wet fluoride and bismuth phosphate methods of separating plutonium from uranium and fission products in Room 4 with Thompson; however, in view of his excellent background in inorganic chemistry I intend to move him to the plutonium purification problem, emphasizing volatility methods, as soon as he can be spared. He was quite excited today when Jaffey and I described to him our rather amazing project.

I sent a letter to J. Leonard Dreher in South Gate, California, explaining that I am looking for research men and that I would like him to join us in Chicago. Leonard was a fellow chemistry major with me at UCLA and is now working as a chemical engineer for General Petroleum Corporation in the Los Angeles area. Although I didn't divulge the nature of our work, I did say that it is perhaps the Number One research project in the country and that it is of such character that it will almost certainly have post-war significance and develop into a large industry. I mentioned that Stan Thompson is here with us on leave of absence and that it might be possible for him to make the same arrangements. I cautioned him to keep everything in the letter under the strictest confidence.

Covey left for St. Louis today to inspect our 300-pound sample of UNH, known as Chicago III, that has been bombarded with neutrons since last November 19, and to send ten pounds of it to Gofman. I decided to end the irradiation today in order to give Gofman his sample; it has had a

1/23/43

total of about 175,000 microampere-hours. Covey will return Monday morning, bringing with him our weekly 400-gram sample of neutron-irradiated UNH, plus 3 pounds of the main sample. These samples, being extremely hot, will have to be wrapped in lead sheet before Covey can bring them to Chicago as baggage. In about a week, after the Chicago III sample has cooled sufficiently for handling, Covey will go back to St. Louis to supervise shipping the main portion of it here.

Melvin Calvin is in town for a few days. I am trying to convince him to join Latimer's effort in some research effort of value to the Project. He could bring some fresh ideas to the 94 chemical extraction picture.

Rommel's army is fleeing in Tripoli!

Sunday, January 24, 1943

Alexander Woolcott, "noted author and actor," died today of a heart attack.

Monday, January 25, 1943

Covey returned to the laboratory today and reported on his trip to St. Louis. The third large neutron bombardment of UNH (300 pounds) at the St. Louis cyclotron ended Saturday morning with a total of 177,000 microampere-hours exposure. He brought back our weekly 400-gram sample of UNH and 3 pounds for the neutron-irradiated UNH. Covey was successful in removing about 13 pounds of the neutron-irradiated crystals, including the 10 pounds for Gofman, which he put up into three shielded packages. Langsdorf, along with his wife (who is an artist) and Fulbright, drove him to the Railway Express office last night, from where he shipped Gofman's samples to Berkeley. After I told Covey to go to the hospital here and leave some urine and blood samples to determine if he had had an over-exposure, I sent Gofman a wire to notify him of the shipment.

1/25/43

Thompson today began experiments to test the separation of fission products from the 94 that co-precipitates with bismuth phosphate, using as his starting material for the 94^{239} and fission products a part of the small portion of the UNH which was bombarded at St. Louis from November 19, 1942, until January 23, 1943 (Chicago III), brought from St. Louis by Covey this morning. Thompson is using the standard conditions for the precipitation of bismuth phosphate; that is, 20% UNH, 1 N H_2SO_4 and 2.5 mg of bismuth per cc of solution, with addition of sufficient H_3PO_4 to make the final concentration of H_3PO_4 0.4 M. The solutions were heated to $75^\circ C$ for one-half hour, the bismuth phosphate was separated, after which the intensities of the beta particles and gamma rays due to the fission products were measured with an electroscope. He made a number of determinations adding holdback carriers for various fission products. He finds that about 7-10% of the fission product gamma ray activity and similar amounts of the fission product beta particle activity co-precipitate with the bismuth phosphate under a rather wide range of these conditions. This experiment corresponds to a time of about 2.5 days after the end of the neutron bombardment of the UNH.

Cefola repeated his experiment of last Wednesday, testing the carrying of 94^{239} by bismuth phosphate at high ratios of 94 to bismuth. He repeated the experiment at the ratio of 1:25. He precipitated an initial bismuth phosphate precipitate and separated this, then added more bismuth to the solution and separated a second bismuth phosphate precipitate. He finds a combined extraction of about 95% indicating that under such conditions of precipitation it should be possible to have a good yield of 94 co-precipitated with bismuth phosphate at high ratios of 94 to bismuth from solutions 1 N in H_2SO_4 .

James has recovered from the measles and is back at the laboratory, but the Perlman family, with whom he is living, has now contracted the disease.

We have another pretty new girl in the office to help Edrey Smith. She is Annis Moore, whose husband is an Air Force meteorology student here at the University. Edrey has been overwhelmed by work and finds this a

1/25/43

welcome relief. Arnis will join Edrey in Room 14 and have her desk at the far end of the room near the window. Edrey's desk is situated next to the door to my office, so she faces and greets all comers who enter my office. There is no direct entrance to my office from the hall; the office side of the wall facing the hall holds a blackboard that is used in our discussions and group meetings. My desk is situated at the far end of the room near the window.

I wrote to Vance Cooper, saying that it appears fairly likely that the Met Lab will soon make him an offer. I said that the offer would be less than his present salary, but that "I genuinely feel that a sacrifice in salary would be more than compensated for by the tremendous opportunities and chances for learning presented to you because of participation in this important project. I am favoring the idea of having you come here in my division, that is, the research division, rather than in the engineering division that I mentioned to you when you were here. There is no doubt that it will be best for you to come on a leave-of-absence basis."

Whitaker has asked me to outline the laboratory facilities that we will require for our chemical work at Site X. The floor plant that I submitted in a memorandum to him has an overall area of approximately 2,000 square feet. This seems adequate at this time because we are planning on doing some of the experiments in connection with the pile at Argonne, using laboratory space there and in our New Chemistry Building here on Ingleside Avenue. Our laboratory space at Site X will be used for performing the necessary purification steps on the plutonium we receive from the separation plant and also for trouble shooting in connection with the chemical engineers' work in the separation plant.

My new title at the Laboratory is "Section Chief, Chemistry of Final Products"; our chemistry section has been designated Section C-I. Most everyone here has a new title, although his duties remain essentially the same. Burton is Co-Section Chief, along with Franck, who is Director of the Chemistry Division, of Section C-II, "Radiation Chemistry," Coryell is Section Chief of Section C-III, "Chemistry of By-Products," and Boyd of

1/25/43

Section C-IV, "Analytical Chemistry and Control." We received a memorandum today, accompanied by an organization chart (see Table 1), to explain how our project has been reorganized and to state our separate responsibilities. For instance, Section Chiefs are responsible:

1. For the operation of their Sections to meet the programs and time schedules agreed upon with their divisional directors.
2. For supervising actively all experimental or theoretical work or design.
3. For recommending assignment of Group Leaders for the Division Director's ratification, and to assign other personnel.
4. For approving the reports presented by the Group Leaders.
5. For suggesting new researches for obtaining design information and data of fundamental importance.

The reason for the reorganization of the Laboratory was given as follows: "Recently du Pont accepted a contract for the design, construction and operation of possibilities for plant design and to decide in what direction the program of the project should go. Up to the present time this responsibility has been of the same importance as the responsibility for carrying through the associated theoretical and experimental work upon which any design would have to be based. In the new phase of our work this is no longer true. Since the chief claim for the practical consideration of our project in comparison with others lies in the possibility of swifter completion, the direction which the design, construction and operation program must take must be determined by engineering considerations based on the studies which we have already completed. The continued canvassing of the field for new types of unit design and of new separation methods and the carrying of such studies through the preliminary design stage, still remains an important part of our task, but it is of only minor importance compared to our major responsibility which from now on must be to supply the du Pont engineers and operators with the technical information they need for their share of our joint endeavor and to maintain constant liaison with their staff while the work progresses to insure that the design at all stages meets the nuclear physics requirements.

"In order to meet our new responsibilities, it will be necessary for us to operate under a more specifically defined organization and under a

Table 1
Organization Chart of the Metallurgical Project and Metallurgical Laboratory (as of January 23, 1943)

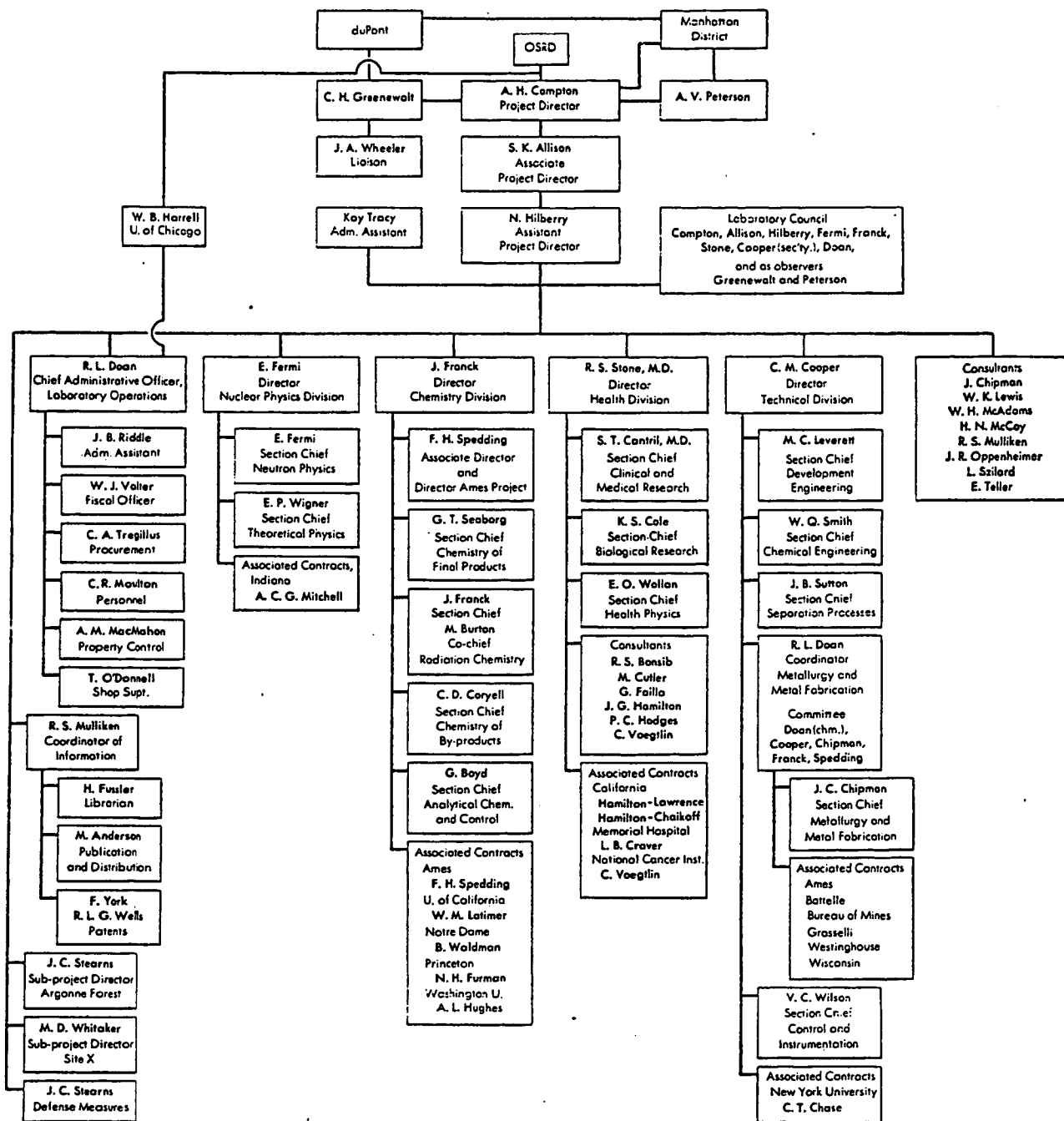

1/25/43

more rigidly observed procedure than has been necessary or advisable in the past. Both the Army organization and that at du Pont is of necessity complex. Unless we have a well-defined organizational procedure which is thoroughly understood by both the Army and by du Pont, serious delays due to confusion and misunderstanding are bound to occur. The organization and procedures indicated below have been designed specifically to meet the requirements of the situation in which we must work during the coming months."

Thursday the Technical Council will meet for the last time. A new council has been formed, called the "Laboratory Council." This council is made up of the officers having the primary responsibility for the general, technical and operational administration of the Project. It is composed of the Project Director, the Associate Project Director and Assistant Project Director, the four divisional directors and the chief administrative officer. The Area Engineer will act as observer for the Army, and the technical director of the DSM Division of du Pont will act as their observer. Thus the Laboratory Council consists of Allison, Compton, Cooper, Doan, Fermi, Franck, Hilberry, Stone, and, as observers, Major Peterson and Greenewalt. The Director may call into a council meeting any member of the staff whose advice he desires to have considered. The Council will meet several times each month. Some of the meetings will be used to inform the administrative staff about the current status of the Laboratory's program; others will be concerned with matters of Laboratory policy.

Schroeder, who has been a Laboratory Assistant to Covey for the last six months, came into my office to say goodbye to me. He will be terminating tomorrow, having been called to the Armed Forces. As of today, the total number of persons working at the Met Lab is 413; these include scientists, administrators and all other support.

I took the evening train for Ames, Iowa, where I will visit the Project laboratory at Iowa State College.

Tuesday, January 26, 1943.

I spent a full day with the Ames Project Group, which is under the direction of Spedding, inspecting their facilities and talking with staff members, some of whom I had at the Chemistry Conference held at the Met Lab last April. I was particularly interested in the uranium metal production facilities because the chief reason for my coming to Ames is my interest in the future production of plutonium metal. I had helpful discussions with Spedding, H. A. Wilhelm and I. B. Johns.

The Ames Metallurgical Group has set up a pilot plant to produce uranium metal ingots on a production basis; in fact, much of the uranium used in the first chain-reacting pile came from these facilities. Chunks of uranium metal are being formed by the calcium reduction of uranium tetrafluoride in crucibles or bombs. Reduction by magnesium is also under way, although because of the higher reaction temperature required, crucibles and ovens have been burning out. For instance, if the lid on the bomb does not fit tightly, a stream of hot magnesium vapor is vented, which melts the bomb and then a magnesium fire ensues. Once this problem is solved, it appears that magnesium reduction, because of its proven superiority, will supplant calcium reduction as the chief source of uranium metal in non-powder form. Metal Hydrides in Beverly, Massachusetts, has been providing the Project with uranium powder, but production is slow because the powder is not always of sufficiently high purity, and to get the uranium into usable form, the powder must be melted and then cast into lumps.

I also had discussions with the radiochemists, Adolf F. Voigt who is working on 94 chemistry, and Amos S. Newton and W. H. Sullivan, who are working on the behavior of fission products in the Ames metallurgical methods for separating 94. These men have a good background in radiochemistry, having been students of Professor Kasimir Fajans at the University of Michigan. I knew Newton while he was an undergraduate student in the Chemistry Department at Berkeley where he worked as a part-time assistant in the chemical storeroom.

I took the overnight train back to Chicago, my mind obsessed with thoughts of how to adapt the process I have just seen to the production of

1/26/43

plutonium metal in the near future and whether or not suitable refractory materials will be available or can be found.

Wednesday, January 27, 1943

Today Cunningham and Werner made another determination of the formula of plutonous iodate in order to establish the oxidation number of plutonium. Working with 6.35 micrograms of plutonous iodate, they titrated this with a standardized thio-sulfate solution and determined that the percentage of iodate is 72.5, compared with an expected 74.5 percent for the formula $\text{Pu}(\text{IO}_3)_4$. This is additional evidence that the oxidation state of plutonium in the lower oxidation state with which we are working is +4.

Allison and Boyd have been considering the advisability of installing equipment here for the microdetermination of hydrogen and carbon in uranium metal. At present, the only places where such determinations can be made are at the Bureau of Standards in Washington, D.C., and the Metal Hydrides analytical laboratory in Beverly, Massachusetts. The method of making these analyses is copied after that in use at the Bureau and the cost of the equipment is around \$700. Allison sent me a memorandum stating that, if I could share the equipment with Boyd, say for the microdetermination of carbon in my plutonium purification program, he would feel justified in ordering it. After I showed the memorandum to Cunningham and we talked over the matter, I sent Allison a reply, saying that the equipment would be very useful to us in several ways in connection with our purification program.

Today Stan Thompson and I signed patent papers in connection with case no. S-72 entitled "Phosphate Method for Separating Radioactive Elements," which covers the Bismuth Phosphate Process for separating 94 from uranium and fission products.

President Roosevelt is in Africa meeting with Winston Churchill.

Thursday, January 28, 1943

Today Cunningham and Werner performed an experiment to determine the oxidation number of the upper oxidation state of plutonium. Working on the ultramicroscale and using about eight micrograms of plutonium, they oxidized this at about 93°C for 20 minutes with an exactly equivalent quantity of dichromate ion, that is, a quantity only sufficient to raise the oxidation state of the plutonium by one unit. They then added lanthanum as carrier and precipitated lanthanum fluoride by the addition of HF. They find that a very small percentage of the plutonium precipitates with the lanthanum fluoride, indicating that it is essentially completely oxidized. It must be concluded that there exists a fluoride soluble oxidation state of plutonium having an oxidation number one greater than that of the fluoride insoluble state; the existence of a still higher oxidation state, of course, is not excluded. It is interesting to note that during the oxidation the color of the dichromate disappeared completely and the resultant solution of oxidized plutonium appeared to be colorless. This might be considered to be evidence for a +5 oxidation state of plutonium in aqueous solution.

Continuing his experiments with the neutron-bombarded UNH—the samples whose bombardment ended January 23, 1943 (Chicago III)—Thompson tried some experiments in which the bismuth phosphate after precipitation was dissolved in HCl and then lanthanum fluoride precipitated from this solution. Measuring the beta and gamma activity due to the fission products, he finds that only the order of 1-2% of that originally present remains in the lanthanum fluoride precipitate.

I sent a letter to Professor Eastman in the Department of Chemistry at Berkeley, telling him that a week or so ago we shipped him some thoria and pure graphite, as well as ten pounds of uranium. I asked him to be sure to fill out a formal request for the uranium metal because the Army wants to keep track of every bit of uranium that goes out of Chicago. After making a few comments about Magel's unsuccessful experiments on the melting of uranium metal on metallic ribbons and his own research on coating metal by deposition from organic solvents, I concluded by saying,

1/28/43

"I have not yet made any plans toward our junket through the East to survey metal production because it seems a little early to do so. Gofman and Garner and perhaps also Professor Latimer are coming to visit Chicago in about ten days; therefore I suspect that any such trips should be delayed until after this visit. However, there is a good deal of red tape involved in arranging such a trip, so we should begin to make rather definite plans fairly soon."

Leonard Carmichael, Director of the National Roster of the War Manpower Commission in Washington, D.C., sent me a form letter asking about Gofman, which will be used to assess his future draft status. I returned the questionnaire, saying that Gofman has a Ph.D. in chemistry, is an extremely able research man, very intelligent and has good judgment and a fine character. I added that all available men with his type of training have been absorbed into war work.

The U.S. Eighth Air Force made its first air attack on Germany yesterday, bombing the docks at Wilhelmshaven.

The Technical Council met today for the last time as such. In attendance were Compton, Cooper, Fermi, Franck, Hilberry, Mulliken, Peterson, Spedding, Stearns, Wheeler, Wigner, and Wollan. Fermi gave a resume of typical experiments that have been conducted at West Stands Pile I. Most of these experiments are possible because the pile has a very high sensitivity for change in the multiplication factor k , one or two parts per million. After some discussion of the pile among members of the Council, Fermi then outlined other pile experiments under way, for example, changing the 14 six-pound metal lumps in the removable stringer to oxide lumps (complete removal almost stops the pile).

The meeting concluded with Compton reminding those present that in the future there will be Laboratory Council meetings of two types, Information and Policy. The Information Meetings will be held on Mondays, each division in turn on a four-week cycle. Policy Meetings, related to the individual divisional Information Meetings,

1/28/43

will be held for each division on the Wednesday following the division's Information Meeting. The first Information Meeting will be held next Monday at 10:00 a.m., followed by a Policy Meeting on Wednesday. Mulliken said that the general Research Associates meetings are now planned for the first and third Thursdays of each month; Chemical Division meetings will be held on alternate weeks, and he suggested that other Divisions or groups plan their own meeting times.

The Russians have continued to gain at Stalingrad, and the seige of Stalingrad is over!

Friday, January 29, 1943

Cunningham and Werner repeated the experiment that they performed yesterday, that is, the oxidation of plutonium originally in the oxidation state (IV), with a limited amount of dichromate ion and again find that the plutonium is oxidized to a fluoride soluble state, indicating oxidation to a +5 state.

Brown and Hill have completed their measurements on the UF_6 distillation performed on January 14. They find that along with the UF_6 , which was essentially completely distilled, only 4.5% of the 94, 1.5% of the 93, about 5% of the gamma rays from the fission products, and about 7% of the beta particles from the fission products are in the UF_6 fraction. These results have considerable interest from the point of view of a UF_6 -operated pile, because they indicate that after the neutron irradiation of UF_6 flowing through such a pile a distillation can serve to remove the uranium from much of the 94, 93 and fission products.

Brown and Hill fluorinated a sample of bismuth phosphate precipitated from neutron-bombarded uranyl nitrate solution. The neutron-bombarded material is from a St. Louis sample and the bismuth phosphate was prepared by the chemical engineering group working on the Bismuth Phosphate Process. Upon hydrofluorination they find that about 30% of the gamma activity is removed and upon fluorination an additional 5% of the gamma activity

1/29/43

is removed from the bismuth phosphate. They also performed a similar experiment upon lanthanum fluoride precipitated from a solution of similar neutron-bombarded uranyl nitrate, the sample again prepared by the chemical engineering group working on the Lanthanum Fluoride Process. Upon hydrofluorination about 2% of the gamma activity was removed, and upon fluorination another 2% was removed. In both cases the hydrofluorination was performed at temperatures around 600°C and the fluorination at temperatures around 500°C.

Benedetti-Pichler of Queens College sent me a letter of thanks for the rod and tube of clear fused quartz that were sent to him for the use of his student, Rochford, in constructing an ultramicrobalance. He said that Rochford has nearly finished the construction of the balance case, which should prove satisfactory for the preliminary experiments. He offered to send me and Cefola some definite results later on. He also said that the more he thinks about it, the less does the proposition of getting a defense contract appeal to him.

Leonard Dreher wrote to me from South Gate, California, in reply to my letter of last Saturday. He said that if he were a single man, he would be foot-loose to accept my offer in a minute, but he and Dagmar have a son, Gerald, born to them last June 5, and he has built a comfortable house in Downey for his family; so now he must weigh all the factors carefully if he should come to Chicago. He asked for more information, such as that concerning the general nature of the work he would be doing and the housing situation. He also wanted to know Stan Thompson's address so he could correspond with him about it. I called him long distance to ascertain his present salary to see if we can offer him something a little better, and I answered most of his questions as best I could. He seemed quite excited about the idea of getting involved in our kind of war work. He was aware of my past interests and so was not far off in inferring that his work would involve radiochemistry.

I sent a letter to David Lipkin in the Department of Chemistry, Berkeley, telling him that the Met Lab Health Division needs information on techniques for qualitative and semi-quantitative determinations of

1/29/43

microgram amounts of uranium. I know that he and Sam Weissman have solved this problem; I asked if there are reports or other summaries of their work that could be of help.

Paul L. Kirk started to work as a Research Associate in Section C-1 today, coming on a leave-of-absence basis from his position as a faculty member of the Department of Biochemistry at Berkeley. I plan to have him lead our work on plutonium metal production in view of his excellent background in ultramicrochemistry. He and his group, other than Magel (who is in Room 1), will work in Room 13, which will serve as the center for this program.

American troops are narrowing Rommel's escape path in Tunisia!

Saturday, January 30, 1943

Covey loaded our truck with 300 pounds of UNH, which constitutes the fourth batch that will be irradiated with neutrons at the Washington University cyclotron in St. Louis (Chicago IV). Since the truck will carry back the 300-pound "Chicago III" sample on its return trip, Covey also loaded on some lead bricks, to make certain that there will be enough to make a four-inch wall to shield the driver from gamma rays. Covey will leave on the train for St. Louis tomorrow, where he will supervise the unloading and loading.

Whitaker received a letter from Greenewalt in Wilmington, Delaware, saying that the du Pont engineers are now considering the proposal to use air as a cooling medium for the pile to be erected at Site X. Greenewalt asks for estimates on (a) the total amount of fission activity released into the cooling air for 50 kw and 1,000 kw power outputs of the pile, (b) the percentage of this fission activity that would be deposited in the pile and the fans and stack, and (c) the amount of fission activity that would be released at the top of the stack.

1/30/43

Many people have been added to the Berkeley Group during the last couple of months, including Professors E. D. Eastman, G. K. Rollefson and A. R. Olson. I have received an organization chart which lists the people as follows. Leaders—W. M. Latimer and E. D. Eastman.

Secretaries—L. Moquin and J. Dorn. Separation and Purification—C. S. Garner, J. W. Gofman and R. E. Connick in charge; R. B. Duffield, G. E. Sheline, R. Craig, J. W. Hamaker, C. G. Blanchard, J. E. Fredrickson, H. W. Crandall, G. E. Pimentel, L. J. Beaufait, E. L. King, M. V. King, M. L. Woodard, W. C. Orr, S. T. Abrams and N. R. Reed. Metal and Refractories—E. D. Eastman in charge; R. A. Webster, O. A. Cook, B. J. Fontana, J. A. Campbell and N. L. Lofgren. Analytical: Spectroscopic—G. K. Rollefson and H. W. Dodgen; Oxygen—A. R. Olson and L. Brewer.

President Roosevelt has stopped in Liberia and Brazil on his return from his meeting with Churchill in Casablanca.

Sunday, January 31, 1943

This is the tenth anniversary of Hitler's assuming power. The RAF bombed Berlin twice, but Hitler was not there—only Goering and Goebbels.

FEBRUARY 1943

Monday, February 1, 1943

Joseph B. Sutton, the du Pont man who was assigned the position of Section Chief for Separation Processes in Cooper's Technical Division, started work today. His office is in the quarters we just vacated in Jones Chemistry Laboratory, and his men will work in our former laboratories there.

Daniel R. Miller started work as a Research Assistant in Section C-I today. He comes to us as a biochemistry graduate student from the University of Wisconsin. John Willard was his senior thesis adviser, as he was for Ed Bohlmann, a high school friend of Dan Miller and his roommate for four years as an undergraduate at the University of Wisconsin. I plan to have Dan work on extraction process chemistry with Stan Thompson in Room 4.

Theodore J. La Chapelle also started work as a Research Assistant in Section C-I this morning, also coming from the University of Wisconsin where he was a graduate student. He will work with Willard in Room 11 on the adsorption processes for the extraction and separation of plutonium from uranium and fission products.

Perlman had a discussion with Coryell today to try to convince him to direct the work of his people more toward the practical applications of developing a process for the extraction and decontamination of plutonium from fission products. The work in Coryell's section is of a more basic nature and not connected with the practical problems being faced by our Section. Perlman suggested a closer working relationship tied more directly to the separations processes under development.

2/1/43

I received a letter from Gofman saying that he and Garner are leaving Berkeley next Friday and will arrive in Chicago on Sunday; he asked that I make reservations for them at the Miramar Hotel (where I recommended they stay).

In response to a recent request I made of Hamilton in Berkeley for some 8-day iodine, I received a wire saying that none is on hand but if we need it badly enough they will interrupt their work to make some. I replied that we would appreciate getting about 300 microcuries whenever it is convenient. This is needed in order to study the role of this radioactive isotope of iodine as a fission product in the chemical extraction process, especially in the uranium metal dissolving step when it might be released into the air and constitute a health hazard.

I sent a letter to Leo Levanas in Los Angeles asking if there is any possibility he might come with us. I explained that we need him more now than when I wrote to him last May and conversed with him in June. If he comes on a leave-of-absence basis, I said, his value to his company would be increased because of the nature of the work here.

Helen and I had dinner at the Quadrangle Club on the campus with Robert Stone. After dinner Helen and I went to the Frolic Theater at 55th and Ellis to see "Yank at Eton" with Mickey Rooney and Freddie Bartholomew, and "Flying Tigers" with John Wayne and John Carroll.

The Laboratory Council met today for the first time; it was an Information Meeting to review the activities of the Technical Division under Charles M. Cooper. In attendance were Allison, Chipman, Compton, Cooper, Creutz, Doan, Fermi, Franck, Hilberry, Howe, Leverett, Mulliken, Peterson, Smith, Spedding, Stearns, Stone, Sutton, Whitaker, Wigner and Wilson.

Cooper opened the meeting by saying that the principal problem of the Technical Division is to evaluate and go after information for plants already decided on and those in the process of design. After Leverett discussed the program of his Engineering Development Section and gave some examples of problems to be studied, Cooper

brought up the subject of chemical extraction of 94. He said that those extraction processes developed on a milligram scale by the Chemical Division and showing the greatest promise will be taken further by the Technical Division. In commercial practice, he said, a step-up factor of 3 in size is considered reasonable, 10 is large and 100 too large. Two sections in the Technical Division will be devoted to such a step-up: (1) Bart Sutton's section (Separation Processes) will take over directly from the chemists and work on the beaker scale, studying how to get desirable types of precipitation, etc. (2) W. Q. Smith's section (Chemical Engineering) will then go as far as possible toward plant scale.

Sutton amplified on the duties of his section by saying that in general they will work on problems already turned up by the chemical and engineering groups in obtaining information for plant design. The chemical engineers, for example, often find new problems causing difficulty on a large scale, such as nitrogen oxide fumes on dissolving metal and corrosion in centrifuges by hydrofluoric acid. His section is now attempting (1) to find another acid, such as H_2SO_4 , to dissolve metal, (2) to find precipitates that can be filtered by simple methods, (3) to solve numerous other problems needing additional manpower: (a) solution of precipitates, (b) decontamination on a larger scale and (c) waste disposal problem, especially if metal recovery is required. Cooper added that Sutton's section must continue to do scouting work, leading to possible processes, finally to be boiled down to choosing the best, whereas Smith's section is now concentrating on the most promising process (wet fluoride). Smith then spoke about his section. Its function as a process development section is to extract plutonium from uranium, solve problems of decontamination and test various types of equipment. The Wet Fluoride Process is typical of a group of processes being studied; so probably it can be adapted to other processes. His section plans to work out size of equipment for final plant on a scale of 1:100 and material from the latest St. Louis bombardment of UNH will be used to study this. The equipment assembly is nearly complete, using the chemical laboratory near the Chicago cyclotron.

2/1/43

The remainder of the meeting was spent in discussing metallurgy, and Doan, Chipman, Creutz, and Howe were the principal participants. They talked about the availability of uranium, its fabrication into the required forms, coatings, its thermal transfer properties, etc.

Tuesday, February 2, 1943

Today Cunningham and Werner, working on the ultra-microchemical scale, made another determination of the formula of plutonous iodate by determining its iodine content, employing the same procedure as before. Using a plutonium iodate sample containing 1.51 micrograms of plutonium, they find a plutonium content of 77% as compared with the value of 75.9% in their earliest determination. This corresponds very well to the formula $\text{Pu}(\text{IO}_3)_4$.

Thompson is considering methods of dissolving bismuth phosphate so that he can proceed with a follow-up cycle in the decontamination procedure. He finds that 25 mg of bismuth precipitated as bismuth phosphate will dissolve in 0.10 cm^3 of 6 N HCl. When this is diluted to about 1 cc, however, he gets a precipitate of BiOCl . When he dilutes the solution less than this, he finds that the addition of phosphoric acid does not lead to the reprecipitation of the bismuth phosphate.

During the last several weeks Knox has been investigating the use of SO_2 as a reducing agent in the wet fluoride extraction method. He has determined conditions and concentrations for the reduction procedure and has found that no difficulties are encountered in laboratory apparatus and that the reaction can be carried out very effectively and completely at room temperature. The SO_2 seems to reduce 94 more quantitatively and faster than a comparable amount of hydrogen peroxide, and 30 minutes seems to be an adequate time of reaction.

James and Knox have completed a series of experiments started last year by James on the separation of 94 from uranyl nitrate by crystallization of the uranyl nitrate from solution. Using neutron-

2/2/43

bombarded UNH containing 94 and fission products, they have separated uranyl nitrate by repeated crystallizations decreasing its solubility by the addition of nitric acid. They find that they can retain with 10% of the uranium more than 99% of the 94 and fission products. The remaining 90% of the uranium is precipitated as uranyl nitrate with less than 1% of the 94 and fission activity. This is worthy of consideration as an initial concentration process for 94 preceding one of the separation processes upon which we are working.

The chemical engineers working with Cooper in his Technical Division have been working with semiworks equipment in their room in the Service Building near the cyclotron to test the wet fluoride extraction process. The starting solution containing 94 and fission products is a UNH solution. The first step is oxidation of the 94 in such a solution containing HNO_3 . Then lanthanum fluoride is precipitated, co-precipitating some of the fission products, and this precipitate is removed by centrifugation; a second such by-product precipitation is performed. Then the 94 is reduced by the addition of SO_2 solution, and a lanthanum fluoride precipitate is produced carrying the 94. This precipitate is removed by centrifugation, and a second such lanthanum fluoride precipitation carrying more of the reduced 94 is performed. The effluent solution is then neutralized by the addition of sodium hydroxide.

Covey, who returned from his St. Louis trip last night, reports that everything went satisfactorily at the Washington University cyclotron. He said it was necessary for him to go to the St. Louis gasoline ration board yesterday so that John F. Van Dorn, a driver for the Met Lab, would have sufficient fuel to bring the loaded truck back to Chicago; the truck with its load of neutron-irradiated UNH arrived last night. A good deal of this material will be used by the chemical engineers for their semiworks tests of the Lanthanum Fluoride and Bismuth Phosphate Processes, with the additional objective of helping our chemists recover the 94^{239} that has been produced.

Today Covey is working on orders for new equipment and materials, amounting to about \$20,000, for our new facilities at Argonne Laboratory and our laboratory in the New Chemistry Building.

2/2/43

Continuing my effort to recruit qualified chemists for Section C-I, I wrote a letter to David C. Grahame, Department of Chemistry at Amherst College and my partner in graduate research at Berkeley, and to Paul Williams, an old friend, at the Shell Development Company Laboratory in Emeryville, California, asking each to consider taking a leave of absence and coming to work for me. I also asked Grahame if he has any Amherst graduates he can recommend to me.

Walter Jilek is leaving us today to go into the U.S. Army.

Compton, Allison, Oppenheimer and I held a conference with du Pont representatives on the purification and metallurgy of 94. It was agreed that metallurgy should be carried out at the new laboratory in New Mexico because of the necessity of recovering large quantities of materials and because of the proximity of ordnance; whereas research and development of the chemistry of 94 will continue here in Chicago under my direction. The production of 94 will be carried out by du Pont at the new site in Washington State (now referred to as Site W) when the plant is built.

We followed this up with a discussion of production requirements. I reiterated that I would like eventually to get 100 grams of 94 for the study of purification and separation, but that I would settle for 10 milligrams or so as soon as available. Oppenheimer asked for the same amount, so that between us we will need a total of 20 to 40 milligrams. Assuming a 40% yield, this suggests 50 to 100 milligrams of crude product, which could be produced at Argonne Laboratory by the first of September this year. Oppenheimer and I emphasized that we must have a total of three to five grams of product from Site X by January 1 of next year. In conclusion, Oppenheimer asked for 400 grams of the 94²³⁹ that will be produced at Site W, two months before regular deliveries start.

We held our regular Research Associates meeting in my office this evening. Coryell also attends these meetings, the only non-member of my Section to do so. He wants very much to do so, and it has the advantage of improving relations between our Section and his Section on "Chemistry of By-products," which haven't been too good since the issuance of the

2/2/43

Goldschmidt-Perlman report "Survey of Long-lived Fission Products" issued last September. Our new Research Associates, Davidson and Kirk, attended this meeting for the first time tonight—they will be regular participants.

Rumors in the paper today indicate that Lt. Gen. Dwight D. Eisenhower will lead the Allied forces.

Wednesday, February 3, 1943

Our former colleague, Bertrand Goldschmidt, showed up at the Met Lab today. He came to us via New York and plans to stay until Friday of this week, when he will return to his home in Montreal, again via New York. Iz and I proudly escorted him through our laboratories in the New Chemistry Building, and he had a chance to meet the new men. Much has transpired here at the Met Lab since Goldschmidt left us last October 22 when we were in Jones Laboratory, such as, the success of the chain-reacting pile, the rapid expansion of the Plutonium Project and our involvement with du Pont chemical engineers. All this impressed him; but he was especially full of praise for our advances in 94 chemistry and Thompson's new Bismuth Phosphate Process. Iz has promised to give him for his research, four micrograms of 94^{239} from the batch of ether-extracted UNH they worked on together, plus some long-lived fission product material, before he leaves for Montreal.

Goldschmidt told us about the new laboratory at Montreal. The purpose of the laboratory will be to build a pile using natural uranium, with heavy water as the neutron moderator. Goldschmidt's task, among many others, will be somewhat the same as mine—to direct a group doing research on the extraction and purification of 94. Von Halban is heading up the Montreal Laboratory and much recruiting is now going on. In addition to Canadian and Cavendish Laboratory scientists who have agreed to work in Montreal, there are foreign nationals, such as Fritz A. Paneth of Germany, George Placzek of Czechoslovakia, Jules Gúeron, von Halban, Goldschmidt and Pierre Auger of France, and Bruno Pontecorvo of Italy.

2/3/43

As for the laboratory, space is being made in the new medical wing of the University of Montreal and should be ready this month. At the moment, the laboratory consists of offices in a large house on Simpson Street in Montreal, which is crammed to capacity. The University of Cambridge has already shipped equipment, including chunks of uranium and cans of heavy water, which should be arriving at any moment. Although Goldschmidt's spirits run high, nevertheless the Montreal team is being confronted with anxiety and frustration over getting laboratory families settled, development of a laboratory and acquisition of materials such as uranium and heavy water.

It is important to ascertain whether 94 can be oxidized in the presence of HF as a part of the wet fluoride separation process. Today Davidson tested the oxidation of 94 in 10% UNH, 0.5 N HNO₃, 2 N HF and 0.02 M dichromate ion at 65°-70°C for a half-hour. He finds consistently that 50-60% of the 94 is not oxidized under these conditions.

Today I sent a memorandum (MUC-GTS-12) to C. H. Greenewalt summarizing methods alternate to the Wet Fluoride Method for extracting 94. I indicated that our extraction development group under the supervision of J. E. Willard is working on a number of alternate methods to the Wet Fluoride Method for extracting 94 and listed them as: (1) Sodium Uranyl Acetate Method, (2) Bismuth Phosphate Method, (3) Adsorption Method, (4) Crystallization method for concentrating 94 and (5) Iodate method for separating 94. I described the methods briefly as follows:

1. Sodium Uranyl Acetate Method. Sodium acetate and sodium nitrate are added to an 11% UNH solution to precipitate all of the uranium as sodium uranyl acetate with the 94 remaining in solution in its reduced state; less than 1% of the fission activity comes down with the precipitate. The second step involves oxidation of the 94 which is then precipitated with about 5% of the amount of sodium uranyl acetate which has precipitated in the first step. Over 98% of the 94 and only about 1% of the fission activity is precipitated in this step. The advantages of the method are that it effects a good concentration of the 94 relatively free of fission activity with very little corrosion hazard and it recovers the uranium in relatively decontaminated form. The disadvantages include the necessity

to precipitate and separate all of the uranium before the separation of the 94, and the method involves the use and disposal of relatively large amounts of reagents.

2. Bismuth Phosphate Method. Here the 94 in reduced form is co-precipitated with bismuth phosphate from 20% UNH solution with a yield of about 98% of the 94 and carrying with it less than 1% of the uranium and about 7% of the gamma activity four days after shutdown of a 40-day bombardment. The precipitation is done at 70°C or above from a solution 1 N in H₂SO₄. After separation of the bismuth phosphate by filtration or centrifugation, the bismuth phosphate may be dissolved in HCl or HNO₃. From the HCl solution the 94 may be precipitated with lanthanum fluoride and a wet fluoride oxidation-reduction cycle may be carried out. When the bismuth phosphate is dissolved in HNO₃, this may be followed by an oxidation-reduction cycle involving bismuth phosphate, a process which is yet to be worked out. The advantages include the fact that the bismuth phosphate precipitate is small and can be readily filtered or centrifuged and the solutions are non-corrosive; also the precipitation of the bismuth phosphate takes place from a relatively concentrated solution of UNH so that an oxidation step in the presence of the bulk of the uranium is avoided.

3. Adsorption Method. The 94 in reduced form in 10% UNH solution is passed through a column of diatomaceous earth. This treatment removes all of the 94 and about 5% of the uranium and about 15% of the fission product gamma activity corresponding to one week after shutdown of a 40-day neutron bombardment. The second step consists of washing the column with 5 N HNO₃ during which the leading edge removes the 94 together with the adsorbed uranium and less than 2% of the original fission product gamma activity. This procedure has worked well when small columns are used, but difficulties have been encountered in attempting to scale up to 100 cm diameter columns.

4. Crystallization method for concentrating 94. In this method the original UNH solution containing 94 in the reduced state with an excess of HNO₃ at 60°C is cooled to room temperature with stirring, resulting in the crystallization of UNH. Under these conditions about 85% of the 94 concentrates in the liquor and by a three-stage counter-current process 99% of the 94 can be concentrated in 8-12% of the uranium. The fate of

2/3/43

the fission products has not yet been determined. Methods of separating the crystallized UNH have not been perfected, and the method has not yet proved itself with respect to reliability.

5. Iodate method for extracting 94. The 94 in reduced form is co-precipitated with thorium iodate from a 10% UNH solution. The precipitate carries more than 95% of the 94, less than 5% of the uranium and less than 20% of the fission product radioactivity. The thorium iodate precipitate is separated by centrifugation and is readily soluble in dilute HCl. After solution of the precipitate, the 94 is oxidized by means of dichromate ion and a second thorium iodate precipitation is made which leaves the 94 in solution in the oxidized state together with about 5% of the fission product gamma activity and less than 5% of the uranium. Problems with the method include the use of corrosive HCl. Attempts to use HNO_3 as the dissolving agent lead to problems with the precipitation of uranyl iodate.

Compton put our yesterday's meeting on record by sending a letter each to Allison, Oppenheimer, Greenewalt and me saying, "The schedule of '49' requirements and demands is as follows: (1) 10 milligrams to Site Y (the New Mexico laboratory) as of approximately September 1, 1943, and 10 milligrams to the chemists at the Chicago laboratory as soon after this date as is practicable. This material will come from the Argonne Unit. (2) Two grams to Site Y by about February, 1944, in the form of metal of known purity. This material will come from Site X through the Chicago laboratory. Additional material from Site X in gram amounts will be made available to the Chicago laboratory and its possible use at Site Y can then be considered. (3) 100 grams of '49' from Site X will be supplied to the Chicago chemists by July 1, 1944, if by January 1, 1944, it has not been possible to find adequate methods of solving the purification problems without the use of such amounts. (4) For the use of Site Y, 500 grams of pure metal are required presumably from the operation at area W, not less than two months before kilogram deliveries on a regular basis are made."

General Groves is paying another visit to the Metallurgical Laboratory today.

2/3/43

Franck, as Director of the Chemistry Division, has asked all of the Section Chiefs to submit organization charts for their sections. I spent part of today (in conference with Perlman) thinking about mine. I also sent a memorandum to Stearns regarding the chemical division at Argonne Laboratory. I wrote that I am appointing Perlman to head the group on "General Chemistry." "In my present plans," I said, "there will be only the one group in the chemistry division and Mr. Perlman will, through you, contact and keep in touch with those who will have problems of a chemical nature in other divisions, so his group can plan to fulfill these needs. He will send you shortly the list of personnel which he expects to have in his group, and later on a memorandum outlining the functions of his group and including the new problems in which they will be engaged."

Continuing his ordering, Covey ordered about \$60,000 worth of laboratory equipment today, mostly for our operation at the Argonne site.

Emil Fulan started to work with us as Laboratory Assistant today.

Helen and I went to the Woodlawn Theater on 63rd Street near Kenwood Avenue and saw the movies, "Lady in Distress" and "Bombay Clipper."

According to the news reports the U.S is engaged in a great air-sea battle in the Pacific. The Japanese are making a major drive to retake the Solomon Islands and claim to have sunk five U.S. ships.

The first Policy Meeting of the Laboratory Council was held today. In attendance were Allison, Compton, Cooper, Doan, Fermi, Franck, Greenewalt, Hilberry, Spedding, and Stone. The two types of Laboratory Council meetings—Information and Policy—were referred to. There was considerable discussion on how to get information to Division directors, group leaders and Research Associates, and it was finally decided that Divisional Information Meetings will be held on Monday mornings and either Compton or Allison will attend and give a synopsis of general progress. Compton pointed out that my group has very close liaison with Latimer's group and Cooper said that Sutton and Smith have been meeting with me and my people.

Compton then asked Cooper for the report of his Technical Division; this Division was scheduled to report because it had its Information Meeting on Monday. Cooper replied that he wished to get general approval of his program and personnel requirements; also to initiate steps toward obtaining adequate working space. He then went into detail about each of the sections. What he had to say about the sections on Separation Processes and Chemical Engineering is the following:

"The Separation Processes group under J. B. Sutton has just been organized and at present consists of four men. It is charged with the development of process from the small scale of the chemists up to the point where the Chemical Engineering Group can carry it along on a miniature industrial scale.

"The present personnel are seasoned men from du Pont research and development organizations and have a broad background in the forming and handling of precipitates and the modification of precipitate characteristics. Several additional younger men will be required and will be obtained as soon as possible. Two laboratory assistants and a stenographer will also be needed. The present space in the fourth floor of Jones is just about adequate for the work. Additional counting equipment will be required.

"The functions of the Chemical Engineering Group under W. Q. Smith are to develop process design information and to test processes on a large enough scale and with such equipment that step-up to plant scale can be taken with confidence. It is anticipated that work of this character will continue at Chicago for the duration of the Project. It will also be necessary to furnish from this group trained personnel to help in the initial operation of both the Argonne and the Site X plants. Twelve men make up the present Chemical Engineering Group. Most of these should remain at Chicago although some will be used during the extraction period at Argonne. Besides these it will be necessary to provide for shift work at Argonne, six more men. These should be picked with the expectation of transfer to Sites X or W, and should be of higher calibre than would otherwise be required. We propose to obtain these men through the D.S.M. Division of du Pont, to report about March 1st."

Thursday, February 4, 1943

Nick S. Dallas started work in the C-I Section half-time as a Research Assistant, coming from the University of Chicago where he has been a student. I am assigning him to work with Ted Magel on the 94 metal production problem in Room 1.

I attended a meeting with Franck, Coryell, Boyd, and Burton, in Franck's office, to discuss the new organization of the Chemistry Division into four sections—Chemistry of Final Products, Radiation Chemistry, Chemistry of By-products and Analytical Chemistry and Control—and the group leaderships within each of the Sections. We also decided to have a regular Chemistry Division Seminar, to meet each Monday evening in Room 251, Ryerson Laboratory; each program will be under the leadership of one of the four Section Chiefs, or of Spedding (to cover work at his laboratory at Iowa State College at Ames, Iowa) or the members of Latimer's University of California chemistry group. Attendance will be by group leaders and senior research associates.

Stearns sent me (as well as Compton, Cooper, Cantril, Wollan, Cole, Wilson, Jones, Newson and Froman, who are also concerned) a memorandum containing the latest information about the Argonne Project. He said that graphite will arrive at Argonne Laboratory at the rate of five carloads per week during the month of February. The schedule for uranium metal production is somewhat uncertain but seems to be about five tons per week. Future deliveries, plus what we have on hand, should provide 50 tons by April 1 of this year. Machining of graphite is now being done at Argonne Laboratory at the rate of 20 tons per day. The general and private laboratories located on the second floor have been assigned to the Chemical Division. The basement corridor has become the control room and the control "dugout" is used for fuel storage. Effective tomorrow, three autos will transport passengers between the campus and Argonne Laboratory on a regular schedule—they will make a trip once in the morning and once at night.

2/4/43.

Helen and I had Goldschmidt to dinner at our apartment, after which I took him to the initial seminar of and for research assistants in my office. These will take place each Thursday evening in my office to give the younger men, the Research Assistants, including Covey, whom we have now promoted to the rank of Research Assistant, a chance to learn and exchange information on what is going on in the Metallurgical Laboratory. I conducted the meeting this evening. Willard, Perlman, Brown, English, Kirk and Thompson will conduct subsequent meetings; and Research Assistants as well as Research Associates will give talks. Tonight I spoke about piles, their rate of production of 94^{239} and attendant problems, Koshland spoke on oxidation-reduction cycles, Goldschmidt (yes, we made him work) on deuterium-moderated piles, James on the determination of the half-life of 94^{239} by measurements on the $93^{239} \rightarrow 94^{239}$ decay chain and Knox on separation processes.

I thus missed the regular Laboratory evening meeting for Research Associates, at which Lyle Borst and Milton Burton were the speakers.

Friday, February 5, 1943

Today Cefola, working on the ultramicroscale with about 0.1 microgram of plutonium in the lower oxidation state, that is, Pu^{+4} , prepared a plutonium compound with ferrocyanide. This compound appears to be green using reflected light. Rough solubility measurements show that it is soluble to the extent of only about 10-15 mg per liter in water, has about the same solubility in 6 N HCl, but is readily soluble in concentrated HCl.

In response to yesterday's meeting, I finished the organization chart for my section (see Table 2) and sent a copy of it to Franck, along with a memorandum:

"I am enclosing the organization chart for my section.

"A problem that seems to come up immediately is the question of the present status of the men who were group leaders before the reorganization. All of these old group leaders are now section leaders with the exception

Table 2

SECTION ON CHEMISTRY OF FINAL PRODUCTS

G. T. Seaborg
Miss E. Smith and Mrs. A. Moore, Secretaries

EXTRACTION DEVELOPMENT

J. E. Willard

General Methods

(G. Friedlander)

Research Associates

S. G. Thompson

T. P. Kohman

(V. R. Cooper)

(I. Cornet)

Research Assistants

E. H. Turk

T. La Chapelle

Volatility Methods

H. S. Brown

Research Associate

A. H. Jaffey

Research Assistants

O. F. Hill

E. G. Bohlmann

U²³³ workR. W. Stoughton

3 or 4 men

Laboratory Assistant

E. Fulan

Laboratory Helper

R. Paulsen

PURIFICATION DEVELOPMENT

I. Perlman

Microchemistry

B. B. Cunningham

Research Associates

M. Cefola

C. Smith

Research Assistants

L. B. Werner

(A. Finkel)

General Methods

E. F. Orlemann

Research Associates

N. R. Davidson

(A. Turkevich)

Research Assistants

R. A. James

W. J. Knox

Physical

S. G. English

Research Associate

A. Ghiorso

Research Assistants

A. A. Jarrett

J. A. Crawford

(A. J. Kane)

E. H. Covey

Laboratory Assistant

N. W. Embry

Laboratory Helpers

V. B. Lemke

W. Vogwill

METAL PRODUCTION

P. L. Kirk

Research Associates

T. T. Magel

(H. Baumbach)

R. S. Rosenfels

Research Assistant

N. S. Dallas

2/5/43

of Howe, Perlman and Willard. I wonder whether this distinction is being decided in terms of merit, category of work or number of men supervised. Certainly the problem should be given careful attention. In the case of Perlman and Willard, perhaps they could be designated as group supervisors or perhaps associate section leaders.

"Another question arises with respect to the new group leaders that are being created as a result of the reorganization. I definitely feel that we should be careful not to distinguish between the titles of these men (e.g., Brown, Cunningham, Elliott, English, Stoughton, Sugarman, etc.). Some of these men (e.g., Brown, Cunningham, English, Stoughton) have for a long time been supervising the research of groups engaged in distinct and important phases of the work and should certainly not be ranked below the other newly appointed group leaders, some of whom have not, to my knowledge, ever had this degree of responsibility.

"In the case of Stoughton's group, I am awaiting his arrival from Berkeley this weekend so as to consult with him before picking out the personnel for this group. The men constituting Stoughton's "U²³³ Group" in Berkeley were needed by Latimer and could not come to Chicago with him at this time.

"The arrival time of Friedlander is still indefinite because he is in the process of undergoing clearance. Incidentally Friedlander is a man who has been in this work ever since the beginning at Berkeley in 1940, a great deal of the time in a directive capacity. He was asked last October to suspend his activities in connection with this work pending his definite clearance by the Intelligence.

"Some of the men, whose names are enclosed in parentheses on the organization sheet, have not yet arrived. There are also others for whose services I am negotiating at the present time in order to fill out these groups. Additional workers are especially needed in the metal production group whose program is just getting underway.

"There are two Research Associates at Washington University at St. Louis, as follows: Harry Fulbright, in charge of cyclotron, and Alexander Langsdorf, Jr., in charge of physical and chemical research.

"I will send you very shortly the organization chart for Latimer's division in Berkeley."

2/5/43

I met with du Pont representatives again to discuss material requirements. Du Pont pointed out that the extraction of 100 grams of plutonium from Site X might require another separation plant, which would mean additional expense. I insisted that we need 100 grams to check on extraction methods and to get a final determination of purity and did not back down.

Goldschmidt left this afternoon to visit his parents in New York and then return to Montreal.

Willard and I attended the regular Friday evening meeting of the Technical Division. Cooper asked us to make some chemical tests on extraction by the Wet Fluoride Method, to which we agreed.

Arthur Compton's wife, Betty, is treasurer of the Chicago Metropolitan YWCA and has interested Helen in working with her. So now Helen is volunteering at their finance office (located in the YWCA executive offices at 203 N. Wabash).

Two Soviet wedges in the Caucasus have trapped the Nazis. The Soviet army has cut off German troops in the western Caucasus from Rostov and has broken through the first line of fortifications surrounding Rostov.

Saturday, February 6, 1943

Thompson prepared some bismuth phosphate incorporating tracer 94 in the reduced state. He dissolved this in about 1.2 cc of 6 N HCl and then attempted to oxidize the 94 with dichromate ion at 75°C for a half-hour. Precipitation of lanthanum fluoride from this solution carried about 80% of the 94, indicating that very little was oxidized.

Edwin F. Orlemann started work in Section C-I, coming from the University of California at Berkeley, where he was an instructor in inorganic chemistry. He will work as a Research Associate on the 94 purification problem with the aim, in my mind, that he will take charge of this portion

2/6/43

of our program. I have assigned him to Room 6, where Perlman is also involved in the purification problem.

I sent a letter to Francis A. ("Pan") Jenkins, who is Professor of Physics at Berkeley and on the staff of the Radiation Laboratory, asking him to send us a pound of uranous chloride (UCl_4) for our research here.

In a follow-up memorandum to the one I sent him January 25, I gave Whitaker further details on the new laboratory facilities that will be required at Site X for our chemical work.

The report describing the work of my group, "Chemistry of 94" covering the period January 16-31, 1943, has been issued with the report number CN-454. The work of our group is described as follows. Cunningham and Werner have carried out experiments to determine the iodate content of plutonous iodate in order to definitely establish whether the formula is $Pu(IO_3)_4$ or $Pu(IO_3)_3 \cdot 10H_2O$. The iodate content was ascertained by iodide reduction and ultramicro volumetric determination of the liberated iodine. The result indicates the formula is $Pu(IO_3)_4$. Unfortunately, there is not sufficient plutonium to permit duplicate runs; so the finding must still be considered somewhat tentative. Other experiments have been carried out by Cunningham and Werner to determine the oxidation number of plutonium in the fluoride soluble state, by adding dichromate ion in an amount approximately equivalent to the molar amount of plutonium and determining the percent oxidation as judged by fluoride precipitation. The results of two experiments indicate that there does exist a fluoride soluble state of plutonium having an oxidation number one greater than that of the fluoride precipitable state; this does not exclude the existence of still higher states.

Thompson reports further work on the Bismuth Phosphate Method for separating 94: (1) Experiments by Cefola show that the precipitation of 94 at a bismuth to 94 ratio below 100:1 is inhibited by the presence of sulfuric acid, although recovery can probably be made quantitative by successive additions of more Bi^{+3} . (2) The amount of bismuth carrier can be reduced to about half the present usage (25 mg/10 cc) without reducing yields appreciably; it is also found that adding Bi^{+3} to the H_3PO_4 solutions

2/6/43

("preformed precipitate") carries 94 as well as when the Bi^{+3} is present before the H_3PO_4 addition. (3) An investigation of fission product behavior shows that, under suitable conditions, the bismuth phosphate carries approximately 5% of the gamma activity and 1% of the beta activity. (4) A number of methods have been studied for the development of a second step in the Bismuth Phosphate Process in order to further concentrate the 94; one method giving good preliminary results is to dissolve bismuth phosphate in HCl , oxidize with dichromate and precipitate lanthanum fluoride, followed by reduction with SO_2 and precipitation of 94 with lanthanum fluoride. (5) An extensive investigation of the behavior of 93 has been made with experiments giving widely varying results in the percent of 93 carried by bismuth phosphate (5% to more than 90%). (6) Experiments substituting HIO_3 for H_3PO_4 show 95% of the 94 carried, with the precipitate volume ten times as great as bismuth phosphate. (7) Study has been given to the problems which might occur in a full-scale process where the plutonium concentrations would be high enough so that a significant portion of the plutonium (up to 80%) would precipitate without carrier, e.g., to the question whether plutonium phosphate would carry more fission product activity than bismuth phosphate, whether the filtering characteristics would be different, whether it would dissolve as readily as bismuth phosphate.

Brown, Hill and Jaffey report on volatility methods of separating 94. Distillation of two samples of UF_6 that received neutron bombardments at St. Louis show that by simple distillation 94 and 93 can be separated completely from the uranium; also, a crude distillation will purify the uranium from about 95% of the hard fission product gamma activity associated with it. These results are applied to the conception of a UF_6 pile with liquid UF_6 flowing through suitable tubes in a graphite or heavy water lattice. The UF_6 would be bled from the system continuously and passed into a still where 93, 94 and fission products would be concentrated. Decontamination of 94 by anhydrous means has also been studied, and it is found that 94 can be volatilized from bismuth phosphate quantitatively by fluorine at 600°C . Similar experiments with lanthanum fluoride precipitates show that 94 in small concentrations (one part per million) can be removed only with great difficulty. Chlorination of weighable

2/6/43

quantities of 94 show no visible reaction at 425°C but essentially complete volatilization between 600°C and 700°C.

In the evening, Helen and I took the elevated interurban train to Evanston, where we had dinner with the Foster Yorks in their apartment.

Sunday, February 7, 1943

Helen and I had Ed Orlemann to our apartment for lunch. Ray Stoughton, John Gofman and Cliff Garner arrived in Chicago from Berkeley; Ray is joining my section and the other two are visiting our laboratory. While Orlemann was here at the apartment, we all held a meeting and discussed some of our present and future problems. Gofman and Garner are staying at the Mira-Mar Hotel.

Later, Helen and I attended the movies at the Tivoli Theater at Cottage Grove and 63rd Street and saw "Road to Morocco," featuring Bob Hope, Bing Crosby and Dorothy Lamour, and "Street of Chance" with Burgess Meredith and Claire Trevor.

Monday, February 8, 1943

Raymond W. Stoughton started work in Section C-I as a Research Associate, coming from the University of California at Berkeley, where he worked with me on the discovery of U^{233} , the demonstration of its slow neutron fissionability and the general problem of its production and chemical separation. It is my intention that he carry on the U^{233} research here—in fact, be in charge of it—but in view of the urgency of work on the adsorption method for the separation of plutonium from uranium and fission products, I am having him start on this problem. He will eventually make his headquarters in Room 2 but will be helping Willard in Room 11 in the interim.

2/8/43

Lipkin wrote from Berkeley in reply to my inquiry of January 29 regarding qualitative and semi-qualitative determinations of microgram amounts of uranium. It was a detailed letter suggesting a method of detecting and analyzing for small quantities of uranium that is based on the characteristic fluorescence properties of uranyl ion in rigid media. He said that the method is a result of his and Sam Weisman's experience during the last year and an analytical procedure worked out by Fontana from their suggestions. Fontana found that he could estimate quantities of uranium as small as 0.1 milligram by using a 100-watt mercury arc to excite fluorescence. Lipkin thought the sensitivity could be increased ten- to twenty-fold by employing a 1000-watt, A-H6 high pressure mercury arc manufactured by General Electric. Fontana, at their suggestion, used a phosphoric acid glass at room temperature as a solvent for the uranium sample. They now believe that more reproducible results on smaller quantities might be obtained if 80-90% sulfuric acid were used as the solvent. Because the latter is a more fluid medium at room temperature than glassy phosphoric acid, it would be necessary to make the measurements of fluorescence intensities at -80°C . Lipkin suggested that Magel could be of great assistance in setting up the necessary apparatus.

Levanas sent a friendly, hand-written letter from Los Angeles explaining why he is not free to join us here. At present he is deeply involved in the construction of a plant designed for increasing aviation gasoline production. He said that perhaps in six months he might be available, but in the meantime he will be going through the trials and tribulations of starting up a new plant based upon novel principles.

As I promised Franck in my memorandum to him last Friday, I delivered to him the organization chart for the Berkeley group (see Table 3).

Covey's paper work is getting so heavy that he needs help. Today Elaine Lewitz began to work as a Laboratory Assistant and will help him with secretarial work.

Helen went to the West Side Y (101 S. Ashland Avenue) this morning and in the afternoon attended a Hyde Park Girl Reserve party on 63rd Street.

2/8/43

Table 3

UNIVERSITY OF CALIFORNIA DIVISION ON CHEMISTRY OF FINAL PRODUCTS

Wendell M. Latimer and E. D. Eastman
Mrs. Lois E. Moquin and Mrs. Jane K. Dorn, Secretaries

GROUP I
EXTRACTION DEVELOPMENT
John W. Gofman and
Robert E. Connick

Research Associates
Robert B. Duffield
(until April 1)

Research Assistants
Loren J. Beaufait
Howard W. Crandall
Marjorie W. Evans
Murray V. King

Laboratory Assistants
John A. Miskel
Virginia S. Holmes

GROUP II
PURIFICATION DEVELOPMENT
Clifford S. Garner

Research Associates
Robert Craig
John W. Hamaker
Glenn E. Sheline

Research Assistants
E. L. King
Andrew M. Stein
Norman L. Lofgren
Charles G. Blanchard
Stanley T. Abrams
John E. Frederickson

Laboratory Assistant
Ned R. Reed

GROUP III
METAL PRODUCTION
E. D. Eastman

Research Associates
Beppino J. Fontana
James A. Campbell
(half-time)

Research Assistants
Richard A. Webster
Oscar A. Cook
George C. Pimentel

GROUP IV
ANALYTICAL, OXYGEN
A. R. Olson

Research Associate
Leo Brewer

ANALYTICAL, SPECTROSCOPIC
G. K. Rollefson

Research Assistant
Harold W. Dodgen

2/8/43

In the evening I attended the Chemistry Division Seminar in Room 251, Ryerson Laboratory. Allison spoke on general plans for dissemination of information on the Project, and Spedding and Johns spoke on their research program at Ames.

The imposition of shoe rationing was announced today. Now we will be limited to three pairs per year.

Tuesday, February 9, 1943

Koshland finds that if fluoride is adequately removed by complexing with zirconium ion, dichromate ion oxidation of 94 is feasible; for example, in 1 N HNO_3 and 0.1 M dichromate ion he finds complete oxidation in one hour at 65°C - 80°C . In related experiments he tested the effect of the concentration of nitric acid on the oxidation of 94 by dichromate ion. He finds that the oxidation is complete in one hour at 80°C in 3 N HNO_3 but is incomplete in 4 N HNO_3 and very incomplete in 6 N HNO_3 . However, in one experiment at 99°C , one hour's oxidation showed complete oxidation (98%) even in 6 N HNO_3 . This is important since high acidities are necessary to prevent the precipitation of zirconium fluoride in the use of zirconium ion complexing to dissolve lanthanum fluoride precipitates.

The St. Louis cyclotron neutron bombardment of our "Chicago IV" UNH sample is scheduled to start today and run about two months until 200,000 microampere hours have accumulated.

Stoughton's salary has not yet been finalized and so at my suggestion he went to see Doan about it.

The following memorandum concerning chemical tests on extraction by the Wet Fluoride Process was written by Willard and sent to Cooper: "In accordance with your request to Dr. Seaborg, growing out of the meeting of Friday evening, we are making tests on the following points related to the Wet Fluoride Process:

2/9/43

"1. The possibility of dissolving LaF_3 in zirconium solutions and of concentrating the 94 present in such solutions by an oxidation-reduction cycle. From the results which have been obtained on this question already, it seems probable that a satisfactory procedure can be obtained.

"2. The effect of the corrosion products produced by 25-12 and 18-8 stainless steel in the Wet Fluoride Process on the recovery of 94.

"3. The effect of Cu, Sn, Ni, Zn, Pb and Al, which may be used as coating for the metal in the pile, on the efficiency of 94 recovery by the Wet Fluoride Process.

"4. The effect of radiation levels such as will be present in the processing of the metal from the pile on the efficiency of the Wet Fluoride Process.

"We anticipate that we can give you a report on the first three of these points by February 20 and on the last by March 4."

Up until now there has been some confusion among my people and others at the Met Lab as to who may see material appearing in the CN reports. The Information Office issued a memorandum today, along the lines of Allison's talk last night, listing many people by name who are authorized to receive these reports. It also listed those groups of Research Associates in the Chemical, Technical and Health Divisions (as well as chemistry people at Ames and Berkeley) who are free to read them. All Research Associates in my section are included.

Helen and I had a buffet dinner in our apartment for the Browns, Perlmans, Gofman and Garner. After this, we (except Adele, Lee and Helen, of course) attended the regular weekly meeting of the Research Associates of Section C-I in my office in New Chemistry. Garner discussed the techniques of measurement being used at Berkeley; Gofman spoke on the "Sodium Uranyl Acetate" and Thompson on the "Bismuth Phosphate" methods for separating 94 from uranium and fission products. There was a heated discussion about the efficacy of organic resins for use as adsorbents as the basis for such a separation process. Orlemann and Stoughton attended their first meeting with this group and will be regular participants in these Tuesday evening meetings.

2/9/43

The Laboratory Council held its weekly Information Meeting, attended by Allison, Cantril, Cole, Compton, Cooper, Doan, Fermi, Franck, Friedell, Hilberry, Mulliken, Peterson, Spedding, Stone, Wigner and Wollan. The subject was the Health Division program. Stone, Wollan, Cantril and Cole reported on such varied topics as x-ray and gamma-ray exposures, inhalation of uranium dust, uranium in dog urine, blood counts of personnel working at the West Stands pile and the use of drosophila eggs and bacteria to test the pile's shielding, exposure of guinea pigs to Xe^{127} made in the Berkeley cyclotron, relative effects of slow and fast neutrons, tolerance of the body to toxic materials and various radiations, and pocket chambers to measure gamma-rays and neutrons.

The Soviet army has retaken Kursk, a victory approaching in importance the Russian triumph at Stalingrad.

Wednesday, February 10, 1943

Today Cunningham and Werner tested the carrying of oxidized 94 by sodium uranyl acetate at a uranium to 94 ratio of 1000:1. The sodium uranyl acetate process is being developed by the Berkeley group and the purpose of this ultramicrochemical test is to see whether such a process works at high concentrations of 94^{239} . They find that the 94 is coprecipitated to an extent of about 96% and that upon the addition of further uranium to precipitate additional sodium uranyl acetate, the total yield of precipitated 94 is greater than 99%.

Magel is not in the laboratory today. He went to Detroit to help Creutz with an extrusion experiment at the Wolverine Company and to observe industrial methods and techniques.

Borst sent Franck, Cooper, York and me a memorandum claiming a new method of uranium extraction. It said: "The chief criticism of the method of purification of uranium by ether extraction is the thermodynamic instability of the mixture. The effect of high radiation concentrations

2/10/43

is still uncertain, but will certainly increase decomposition. As an alternative to the use of ether it seems possible to use liquid sulfur dioxide. Preliminary tests have been made, and show that SO_2 is immiscible in H_2O at temperatures of less than 100°C .

"The solubility of uranyl nitrate hexahydrate in SO_2 was tested. A certain amount of reduction occurred, but this was by no means complete. Uranyl ion (as indicated by a yellow color) was found in the SO_2 solution. The commercial feasibility of this method must depend on further work: the study of the system $\text{SO}_2\text{-H}_2\text{O-UO}_2^{++}$, and the following of tracer elements through such an extraction."

This morning I sent a telegram to Clifford Smith, whom Kirk introduced me to in Berkeley January 6, asking if he has arrived at a decision about joining my section. Before nightfall I got a return wire that he sent an airmail letter to Moulton February 5 notifying us that his company, Owens Illinois Pacific Coast, will not release him at this time.

The S-1 Committee is holding a meeting at the Lab today and tomorrow. General Groves is here to attend it.

Helen had Wilma Ghiorso to our apartment for lunch; then went to a Girl Reserves Cabinet program planning meeting.

In the evening I had a talk with Kohman and Coryell about problems in counting the alpha particles of 94^{239} and about the research program at the Argonne site.

Soviet troops have entered the suburbs of Rostov.

Thursday, February 11, 1943

Thompson and Jaffey have made calculations on the effect of radiation upon the reagents and precipitates encountered in the Wet Fluoride and Bismuth Phosphate Extraction Methods. They made the calculations for a 1200 kw per ton pile and six days after shutdown. Maximum decomposition

2/11/43

rates calculated would indicate that the bismuth phosphate precipitate could last 21 days before complete destruction, that in the Wet Fluoride Process the lanthanum fluoride precipitate would last about one and a half days while the potassium dichromate decomposition would also be complete in about one and a half days.

Thompson issued a memorandum (MUC-GTS-22) today summarizing the Bismuth Phosphate Method for separating 94. He points out that the method consists of starting with a solution of 20% UNH, 1 N H_2SO_4 , and 2.5 mg of Bi^{+3} per cc of solution to which sufficient H_3PO_4 is added to make the final H_3PO_4 concentration approximately 0.4 M. The solution is heated to $75^\circ C$ for about one-half hour and the bismuth phosphate is separated by filtration or centrifugation. The addition of small amounts of La^{+3} , Y^{+3} , and Ce^{+3} holdback carriers (0.5 mg of each per cc of solution) before the precipitation has been found desirable to reduce the amount of fission activity carried down by the bismuth phosphate. The second step in the bismuth phosphate method is being developed and a number of alternatives are being studied. The bismuth phosphate precipitate dissolves readily in HCl and lanthanum fluoride can be precipitated from the HCl to separate the 94 from bismuth phosphate, but the engineering group has pointed out that the use of HCl is undesirable from a corrosion standpoint. The bismuth phosphate can be dissolved in 10 N HNO_3 and presumably the 94 could be oxidized with an oxidizing agent such as $S_2O_8^{--} + Ag^+$, or $Cr_2O_7^{--}$ at lower H ion concentrations, followed by the precipitation of bismuth phosphate or bismuth iodate which would be discarded; then the 94 would be reduced with a reducing agent like SO_2 and the 94 co-precipitated with something like thorium iodate. However, experiments of this type have not been successful yet, indicating that the 94 is not oxidized quantitatively in HNO_3 solution containing H_3PO_4 or that the 94 in the oxidized state is precipitated with either bismuth phosphate or thorium iodate. Another possibility is to dissolve the original bismuth phosphate precipitate, oxidize the 94, and then co-precipitate the oxidized 94 with sodium uranyl acetate. However, a way of eliminating the precipitation of bismuth as the phosphate or oxychloride at the low acidity required has not yet been devised. Another method might be to dissolve the bismuth phosphate in 10 N HNO_3 and then reprecipitate it at high H_3PO_4 concentrations. In

2/11/43

addition, there is the method of treating the bismuth phosphate containing 94 with HF and F₂ at elevated temperatures, which leads to the removal of the volatile higher fluoride of 94. Experiments with tracer 93 activity indicate that the behavior of 93 in the Bismuth Phosphate Process is erratic.

Today Cunningham and Werner repeated the experiment of yesterday at a ratio of uranium to plutonium of 100:1. They find that the sodium uranyl acetate carries oxidized plutonium to an extent of 95%. These tests indicate that the Sodium Uranyl Acetate Process will work adequately at the high concentrations of plutonium to be encountered in plant operation.

Today we received back a Form MP-1, "Request for Academic Personnel," dated February 9, approved by Hilberry (signing for Compton) and Franck. It was a request made by Willard and me to hire Bernard A. Fries of Berkeley as a Research Associate. On the form we state that Fries received a Ph.D. in May 1941, that he has considerable experience in radioactivity, and that we want him by March 1 to work in the general extraction group. I knew Fries both at UCLA as a fellow undergraduate student and at Berkeley where he did his graduate work in the Department of Physiology.

I sent a letter to Roy Beaton in Waynesboro, Virginia, who works for the du Pont Company, explaining that we need "the services of a man who has had sufficient experience in the use of adsorption methods for the separation of inorganic ions to be able to apply these methods to unique problems." I said that C. C. Furnas has recommended him as a man who is especially well qualified to meet our needs. I then asked if he would be willing to join us, as we are working on a secret war project of extreme urgency. I cautioned him not to discuss my letter with anyone in view of the secret nature of the work.

Another letter was dispatched to my friend, James J. Lingane, at the Chemistry Department of Harvard University after I reached him by phone. I asked him if he would consider getting a leave of absence and coming to work for me on "one of the most important war projects in the country." I said that we are in particular need of a man with his training and expertise

2/11/43

in quantitative analysis and polarography. I knew Lingane when he was an instructor at Berkeley from 1939 to 1941.

I also wrote to Harlan Baumbach deploring Mr. Freeman's (President of Paramount) refusal to grant him a leave of absence as we have learned from Freeman's letter to Compton; I said Compton will have someone in Washington write Freeman to try to get him to change his mind.

In the evening I attended the Laboratory Research Associates meeting in Rosenwald Auditorium at which Fermi talked on the pile as a precision instrument.

The second meeting of the Research Assistants seminar was held in my office this evening. Willard conducted the meeting and reports covering a wide range of our activities were given. These meetings start at 7:45 p.m. and will possibly run a couple of hours.

A correspondent for a Stockholm newspaper reports that the Germans are evacuating Kharkov. Soviet forces are reported only 22 miles from Kharkov.

Friday, February 12, 1943

Thompson has decided to try to oxidize 94 after bismuth phosphate containing 94 has been dissolved in 10 N HNO_3 , in view of the lack of success with HCl. He tried a number of oxidizing agents, then precipitated lanthanum fluoride--this will not carry the plutonium in the cases where oxidation occurs. An oxidation procedure for 94 in such 10 N HNO_3 in the presence of Bi^{+3} and PO_4^{---} would establish an oxidation-reduction cycle for the Bismuth Phosphate Process. Dichromate ion has been found unsatisfactory at such high acidities. Today Thompson tested the following oxidizing agents under the indicated conditions: permanganate ion for one hour at 95°C ; dichromate ion for one hour at 95°C ; $\text{S}_2\text{O}_8^{--}$ and Ag^+ for one hour at room temperature; Ce^{+4} for one hour at 95°C ; and periodic acid for one hour at 95°C . He finds that only the

2/12/43

$S_2O_8^{--} + Ag^+$ and the Ce^{+4} give satisfactory results although he indicates the possible use of bismuthate ion under modified conditions might be satisfactory.

In answer to my request of last Saturday, Jenkins shipped me one pound of uranous chloride by air express.

I sent a memo to Professor Herman Schlesinger of the University of Chicago saying I would like to interview the following of his students and members of his research projects: Bond, Knight, Lad, Abraham, Finholt, Schulze and Sheft. "I would of course," I said, "be very happy to have Gilbreath, Hoekstra, and/or Hyde come with us if it turns out that you cannot use them, and would appreciate the opportunity of interviewing them at whatever time you think would be best from your point of view. I can say we have definitely made up our minds about Katz, and are ready to offer him a position with us at any time, if he is available to us."

Helen and I went to Northwestern University on the elevated train. She did literature work on my "Table of Isotopes" in the library while I gave a talk. Then we took the elevated to the Loop, where we had dinner at the Triangle Restaurant and afterwards saw Hedy Lamar in the notorious foreign film "Ecstasy" at the Grand Theater on Clark Street near Randolph. We returned home on the I.C.

Saturday, February 13, 1943

One of the problems in working with fluorine has been the difficulty of getting a steady stream when it is necessary to generate it for each experiment. Brown, Hill and Bohlmann, who is now working with Brown and Hill, have solved this problem by placing the fluorine in tanks. The fluorine, which is produced in a high temperature type graphite electrocell by the electrolysis of KHF_2 , is swept along by helium gas through a number of traps to remove impurities, and then condensed in a trap at liquid nitrogen temperature. When the liquid nitrogen is removed, the fluorine

2/13/43

is allowed to boil into the tank until the pressure reaches 80 pounds and this then serves as a good steady supply of fluorine for their experiments.

I sent a letter to Robert L. Patton, of the Department of Entomology, Cornell University, saying that Professors Craig and Kirk have called my attention to his qualifications which are urgently needed by us on an extremely important war project here in Chicago. Craig is working with us in Berkeley, I stated, and Kirk recently came to Chicago where most of the work is proceeding. I asked if he would consider coming with us on a leave-of-absence basis and cautioned him to hold my letter in strict confidence.

Garner and Gofman have been in town all week which has given them the opportunity to talk to many Met Lab people. Kennedy and Wahl are also in town for conferences with a broad spectrum of Met Lab people in connection with their impending move to Site Y.

In a nationwide radio address at the dinner of the White House Correspondents' Association, President Roosevelt promised decisive blows at Tokyo, "constant and unrelenting pressure" on Germany and Italy, with air offensives about to begin in Tunisia.

Sunday, February 14, 1943

At the request of the chemical engineers, I have asked Davidson and Knox to test the effect of corrosion products such as might come from the steel tanks in which the Wet Fluoride Process would be carried out. The chemical engineering group has found that the hydrofluoric acid in the Wet Fluoride Process is corrosive and leads to the solution of some of the stainless steel. They find that the presence of corroding steel in the oxidized solution with HF present leads to reduction of 94 at room temperature even in the presence of the nearly original concentration of unreduced dichromate ion. This is observed with "18-8" steel. But "25-12" steel and "18-8 Mo" steel show little or no corrosion and no reduction

2/14/43

of 94 at room temperature in about a day. At higher temperatures there is even more reduction with the "18-8" steel, while the reduction with "25-12" steel is 5% or less. This indicates that the choice of stainless steel to be used for the fabrication of the vessels in a Wet Fluoride Process would be very important and that this process is vulnerable to the effects of corrosion.

I gave Helen a box of Whitman's chocolates for Valentine's Day.

The temperature has dropped, and we found it down to -3°F at 8:00 a.m. with the high for the day of 8°F at 4:00 p.m.

Frances Chilson, a second cousin of Helen's, spent the afternoon and evening with us in our apartment. After dinner, Al and Wilma Ghiorso and Stan Thompson came over for coffee.

Monday, February 15, 1943

We have received word that General Groves has decided not to go ahead with the plan to produce and chemically separate 94^{239} at the Argonne site. He wants this phase of the Project to be centered at Site X. This means that we must immediately change our rather extensive plans for the chemical separation of 94 at Argonne and cancel the rather substantial orders for equipment that we have placed!

Brown, Hill and Bohlmann today hydrofluorinated a sample of bismuth phosphate at 500°C , converting it to BiF_3 . When this BiF_3 was treated with fluorine at 600°C , there were definite signs of volatilization, indicating the formation of volatile BiF_5 . Such a volatile higher fluoride of bismuth might aid the removal of volatile plutonium higher fluoride in the fluorination of bismuth phosphate precipitates.

"Report for Period Ending February 13, 1943. U^{233} Production and Extraction" (Report No. CN-454) is being issued. In this Stoughton presents information on the two different methods under which a U^{233} -thorium

2/15/43

separation may be made: (1) directly, after a few months of Pa^{233} decay and (2) in two steps, the first separating the intermediate Pa^{233} from the thorium immediately after bombardment, and the second separating U^{233} from the remaining Pa^{233} after sufficient decay of the latter. He reports on experiments to attempt to increase the efficiency of some of the methods already under consideration for U^{233} -Th separation and to seek a satisfactory organic precipitating agent.

Jim Lingane at Harvard's Department of Chemistry replied to my letter of February 11, saying that he has carefully considered my proposal of employment and has discussed it with Professor Baxter, his department chairman. Baxter assured him that he considers his present duties highly essential to the department, and that they will become even more important during the next few months when the Army and Navy "educational program" gets under way. Half the senior members of his department are now wholly in defense work or on leave and so neither Baxter nor the Dean of the College is willing to let him go without definite evidence that the work in question would be more important than his present job. Even if a leave of absence were arranged, he would be reluctant to take it for the duration of the war (probably for two or three years, he said) because he would have to return at the same rank and salary. He suggested another possibility, to arrange a contract so that he can work on our project there at Harvard. He is willing to devote up to twenty hours per week on it.

After lunch with Wilma in our apartment, Helen went to a Girl Reserve meeting.

Coryell, Sugarman, Elliott, and Rubinson gave talks tonight at the Chemistry Division Seminar describing progress on their investigation of fission products.

The Laboratory Council met at 10:00 a.m. for the weekly Information Meeting. The topic was the activities of the Physics Division. Attending were Allison, Anderson, Compton, Cooper, Doan, Fermi, Franck, Hilberry, Mulliken, Peterson, Snell, Spedding, Stearns, Weinberg,

2/15/43

Wheeler, Wigner, Wollan, Young and Zinn. Zinn reported on pile experiments in progress; Anderson spoke on such topics as the exploration of fission neutron energy by n,α and n,p reactions in light elements and the temperature effects on k (a main activity); Snell reported on fast neutron work and the irradiation of whole rabbits for Raymond Zirkle of the Health Division; Wheeler reported on how work is organized at du Pont; Young talked about the recent changes in design for a water-cooled pile; Weinberg, substituting for Christy, discussed a comparison of exponential experiments with theory; and Wigner reported on some theoretical work carried out by people in his group, including the improvement of the diffusion theory of thermal neutrons.

Today the Nazis lost Rostov and Voroshilovgrad, an important industrial center 85 miles northwest of Rostov.

Tuesday, February 16, 1943

I wrote three memoranda today, one going to Franck and the other two to Whitaker. The memorandum to Franck concerns the production of O^{16} and C^{12} for the 94 purification program. It reads as follows:

"I have had some discussions with Urey and Teller in connection with the possibility that enriched O^{16} and/or enriched C^{12} might be extremely useful or even indispensable in connection with the purification problem. The cost of the enterprise, in money, time, and man-power, will of course depend upon the amount of material needed and the degree of enrichment that will be necessary. Making the best estimates that it is possible to make at this time, which are still very rough, it would seem that we would ultimately need about kilogram amounts, with the O^{18} and C^{13} removed by a factor of at least 10, and probably the degree of enrichment could profitably be somewhat more than this. Mr. Urey estimates that isotope separation ventures of this type would probably cost of the order of a million dollars and would probably take of the order of one year's time.

"At the present time it looks like the main use for either of these enriched isotopes is in connection with the refractory material to be used

2/16/43

in connection with the preparation and recasting of the metal. In a choice between the two, O^{16} and C^{12} , it would seem to me at present that the O^{16} would be slightly preferable. The O^{16} is probably somewhat easier to prepare and has the additional advantage, besides its use in the refractory material, of being of more general aid in helping to keep natural oxygen out of the final product.

"I am not writing to you because I think that a decision should be made at this time, but just for the purpose of suggesting to you that this is a decision that will have to be made sometime in the future. I definitely think that it is too early now to decide this question. I think that it should be brought up for serious consideration in about two or three months after we have had a chance to study the problem more carefully and to do some laboratory work on it that we have in mind to do. Mr. Urey made the suggestion that if the decision is made to embark upon this program of isotope separation, authorization to do so should come to him through General Groves."

The first memorandum to Whitaker proposed that space be left with the pile at Site X for the irradiation of 50-100 pounds of thorium salt, which would produce enough U^{233} to make possible further studies of its nuclear properties. I suggested that slots be left in the center of the pile so as to allow for the placing of four 1"-diameter tubes about 20 feet long to contain the thorium salt. In the second memorandum, I reminded him of my memos of January 25 and February 6 in which I said that I will require 2,000 square feet of laboratory space at X-10 for our chemical work. Now that plans have changed and it will be necessary to conduct all our pile experiments at Site X, I asked for 4,000 square feet of laboratory working space, this not including stock room, utility service rooms, etc. Since we will be working closely with Cooper's chemical engineering group and can use many facilities in common, I said that it would be desirable to have our floor space either in the same building with that group or in proximity.

I was pleased to receive the following letter today; it was written on National Research Council, Canada, stationery, and was sent from the Montreal Laboratory, temporarily housed at 3470 Simpson Street: "Please

2/16/43

accept my very best thanks for your kindness in sending me, through Goldschmidt, a copy of your most valuable table. It will decorate the wall of my office as soon as the latter is ready, and I am looking forward to the day when you will come and see me there. As Goldschmidt has told you, we hope to be able to start work in a few weeks time." It was signed by F. A. Paneth and ended with the statement that he is "hoping that it will not be too long before I have the pleasure of making your personal acquaintance." He was referring to a copy of my chart of isotopes which I sent to him via Goldschmidt.

Helen went to the Metro Y office and later saw Dot Jenkins, a friend from Santa Ana, California.

The evening meeting of my Section was devoted to a review of the status of our many research projects.

Russian troops are in Kharkov today. The third day of a tank battle continues in North Africa, the result of an offensive by Rommel.

Wednesday, February 17, 1943

Kohman today tested the oxidation of 94 in solutions containing zirconium ion such as would be present after lanthanum fluoride is dissolved by complexing with zirconium ion. He finds that in 1 N HNO_3 , $0.1 \text{ M S}_2\text{O}_8^{--} + \text{Ag}^+$ oxidizes 94 quantitatively at 25°C in one-half hour.

Latimer wrote from Berkeley saying he has sent Allison a summary of the light water fractions that Professor Randall has on hand (oxygen-18 reduced by a factor of 10 to 20--for possible use in making refractories). He says West is making a furnace to give $2,000^\circ\text{C}$ for sintering thoria, and there is a possibility of Oppenheimer's taking him over in a month or so. Latimer also raised the problem of a possible negative oxidation state of 94, citing rhenium as an example. If we ever run into something like this, he said, 94 metal might be tough to get. He added a postscript that

2/17/43

he expects to be in Chicago next Monday and will give me a call if he doesn't see me.

Beaton of Waynesboro, Virginia, replied to my letter of February 11. He thanked me for my interest in having him come to Chicago and explained that his own work is also of extreme war urgency and it would be impractical to leave. He indicated a willingness to help on a part-time basis, either here or at Waynesboro.

I received a letter from Professor Eastman in Berkeley, thanking me for the reports and other items I have arranged to have sent to him. He informed me that the uranium coating studies of Campbell have been discontinued as I have requested. He expressed continued interest in a possible trip with me to metallurgical facilities in the East.

Alvin C. Graves, a Research Associate under Zinn, will be visiting Berkeley next week. I wrote a letter to Hamilton, saying that Graves will get in touch with him in order to procure some ionium, which should be available from Fontana.

Charles Cooper and I sent a joint memorandum to M. D. Whitaker today regarding our laboratory space requirements within the restricted area at Site X. These are somewhat expanded over our previous requests. We point out that the laboratories for the Chemical Engineering and 94 Chemistry groups should be located as close together as possible in order to share common facilities. We outline in detail our space requirements in two ways—(1) if the two groups are in the same building, in which case the Chemical Engineering Laboratory would need about 3,700 sq. ft. of floor space, the 94 Chemical Laboratory about 3,300 sq. ft. with combined facilities of about 4,000 sq. ft., for a total of 11,000 sq. ft.; or (2) if the buildings are separate, in which case the Chemical Engineering Laboratory will require 6,800 sq. ft. and the 94 Chemical Laboratory 5,900 sq. ft. for a total of 12,700 sq. ft.

Brown and I sent a one-page memo to Cooper showing our calculations for the radiation intensity due to 93^{239} gamma-ray activity in relation to

2/17/43

days after shutdown of a pile operating at a power level of 2,500 kw per ton of uranium for 100 days. First we deduce that gamma radiation from one gram of 93 produces 8×10^7 roentgens (R) per day at a distance of one foot, based on an average gamma-ray energy of 0.4 Mev, a decay rate of 4.3×10^{15} disintegrations per second per gram, and about 0.5 gamma-ray per disintegration. As an example, for such a pile operating at 2,500 kw per ton for 100 days, we estimate that 21 days after shutdown there would be, at one foot, 5.5×10^3 R/day per gram of 94.

In a meeting with Cooper in the afternoon, Willard and Boyd (who is Section Chief of Analytical Chemistry and Control) were asked to prepare a report on the work done to date on adsorption methods for separating 94. They promised to have one ready next week.

This afternoon Helen had tea at Wilma's.

There was a Laboratory Council Policy Meeting at 10:00 a.m. in Eckhart Hall, Room 209, attended by Allison, Cole, Compton, Cooper, Doan, Fermi, Franck, Hilberry and Wigner. Compton announced that the Metallurgical Project will now be responsible to General Groves, rather than to the S-1 Committee. Compton has been resisting du Pont's suggestion that the Laboratory take over the operation of the facilities at X-10, once du Pont designs and constructs them. Today he said that operations at Site X will now become part of the Laboratory's program, but that there are still some details that he must clear. Ground is being broken at Site X and new land is being acquired, but no construction has started. The pile there will operate at 250 kw at first; later it may run up to 1,000 kw. As for Site Y in New Mexico, Oppenheimer's work is no longer under the jurisdiction of the Met Lab; Oppenheimer is now set up to act independently and Manley and others from here will join him. The Princeton project to separate uranium isotopes by the "isotron" process is being closed down and we have asked for some of the personnel to come to Chicago, although Oppenheimer has first call on them and on the laboratory equipment. The final production of 94 into metal will take place at Site Y, and Groves is urging du Pont to

take on that responsibility. At Site W in Washington State, every employee will be on the du Pont staff; at present there are no plans for laboratories there.

The Council discussed the production of heavy water. Du Pont is going ahead on production, using distillation of ordinary water, which will give 2-1/2 tons of D_2O per month with six tons on hand by January 1 of next year. Urey has an alternative sulfide process not yet completely developed. The Canadian plant is supposed to be ready to operate by the last of May this year and is scheduled for one-half ton per month after being brought up to the production level.

Compton thought that a reasonable approach to pile design would be to consider helium and water-cooled graphite piles as the first two lines of attack, with the D_2O pile being brought in as rapidly as possible if the ultimate emergency develops. Fermi asked if the Physics Division should concentrate some effort on heavy water studies and Compton replied, yes, up to the point where it is clear whether or not a homogeneous pile is feasible; if not, to put D_2O into the background for the present.

Compton said he has a letter from Latimer offering four liters of D_2O , in which the proportion of O^{18} has been reduced by a factor of 10-20 over that in ordinary water, for a price of \$50,000. This might be useful in connection with the program for purification of 94. No decision was reached.

Another topic that concerned the Council is the need for training additional personnel for Sites X and W. Compton asked if J. C. Stearns might not be a good man to head the training effort. He said that Stearns has an excellent record and was chairman of the physics department the last year or so at the University of Denver, where he organized the Mt. Evans cosmic ray work. Compton left the meeting early, but not before Allison had a chance to ask if he would sign the requisition to purchase 500 microcuries of mesothorium for \$13,500 (plus postage).

Fermi then led a discussion on the organization of the Physics Division, with emphasis on the need for additional personnel. The

2/17/43

men in Physics Groups III and IV, led by Zinn and Anderson, respectively, will take down the pile in West Stands and rebuild it at Argonne Laboratory. He pointed out that this might afford an opportunity for some of the du Pont men to gain experience in pile construction, should they be willing to participate in an active way in the work. Fermi then listed the space required at Argonne Laboratory, in addition to the pile room, as follows: (1) general laboratory for physics work; (2) laboratory for work with sources; (3) chemistry room; and (4) laboratory for work with hex. In connection with the work on hex, he asked for a chemical engineer.

Thursday, February 18, 1943

The "Report for Period Ending February 13, 1943. Chemistry of 94" with the report number CN-467, has been issued with the following content. Thompson and Jaffey have calculated the effects of radiation from a 1200 kw per ton pile (six days after shutdown) upon the reagents and precipitates encountered in the Wet Fluoride and Bismuth Phosphate Extraction Methods. The oxidizing agent $K_2Cr_2O_7$ would decompose in 1.5 days. Cunningham and Werner have determined the iodate content of a second sample of plutonous iodate and find a value of $77\% \pm 8\%$, which confirms the previous finding that the indicated formula is $Pu(IO_3)_4$. Co-precipitation of oxidized and plutonium with sodium uranyl acetate at plutonium-uranium ratios of 1:1000 1:100 has been found to be 96% and 95% respectively. Cefola has prepared plutonium ferrocyanide and finds its solubility in water and 6 N HCl to be 10-15 mg/liter. Knox has reinvestigated SO_2 as a reducing agent in the Wet Fluoride Process in order to determine whether it is effective at room temperature. It is found that, in general, SO_2 seems to reduce 94 more quantitatively and faster than a comparable amount of hydrogen peroxide and that it will work in 30 minutes at room temperature. James and Knox further

2/18/43

investigated the concentration of 94 and fission products by uranyl nitrate crystallization. It seems possible to separate, with 10% of the uranium, more than 99% of the 94 and fission products.

In the Berkeley part of the report, Connick, Duffield, Garner, Gofman and Wahl report on "Sodium Uranyl Acetate Method for Separation of Plutonium." Included also are sections by Burton describing the latest work by the members of his Section on the effects of radiation on various chemicals used in separation processes, by Spedding and Johns of the Ames Chemical Group on the "High Temperature Behavior of Element 94" and a new section by Schlesinger, Borst, Bond, and Kohman on "Chemical Separation of 94 from Uranium on the Basis of the Volatility of the Boro-hydrides" (in which they find the 94 compound, if formed, is less volatile than uranium boro-hydride).

Patton at Cornell University responded to my job offer of February 13, saying he is giving it serious consideration and that it will help him to decide if he knows what type of work he would be doing, such as routine inorganic ultramicro analysis or physiological chemistry.

I sent a request to Doan for a travel advance for Fries, who will be working in Willard's group, and asked that the check be mailed directly to Fries in Berkeley. I also wired the Department of Chemistry at Berkeley, asking for the negatives of the wall isotope chart in Room 303 (my former office).

In addition to the letter (dated February 13) that Lingane sent me concerning the job offer I made him, I received today a telegram from him about the same matter. I hope my reply today will assure him that the work he would do here is of far more consequence than for him to stay at Harvard and get involved in the Army and Navy "educational program." I told him that the work here is of the utmost importance and has been given the very highest priority by the War Department itself; also, that he is needed for one of the most crucial aspects of the whole program, in a job that demands a person of just his experience and ability. With regard to his question about the possibility of arranging a contract so that he can work part-time for us at Harvard, I explained, because of the nature of

2/18/43

the work, this would be impossible. I suggested that he might come on a six months leave of absence, which would give him time to decide whether he cares to stay longer.

Helen went to Nancy Leverett's for Y work.

The seminar for Research Assistants held in my office this evening was conducted by Brown. He discussed fluorine chemistry beginning with a historical background. He covered methods of production, described the production and properties of uranium hexafluoride and the Dry Fluoride Process for separating and decontaminating 94. Cunningham then gave a discussion of microchemistry beginning with a historical background, described the techniques, and then went on to cover its application to 94 chemistry, including a description of a number of key 94 compounds.

Bad news comes from Africa today where our army has been pushed back 22 miles by Rommel's drive in Tunisia.

Friday, February 19, 1943

We have hired a new Laboratory Helper, Mrs. Mildred M. Summers, while Valda Lemke has concluded her service with us as a Laboratory Helper.

I attended the regular evening meeting of the Technical Division. Others present were Adamson, Apple, Boyd, Cantril, Compton, Cooper, Coryell, Foote, Franck, Jesse, Leverett, Peery, A. V. Peterson, M. D. Peterson, Smith, Sutton and Willard. Peery reported on their four extraction experiments, with one pound of St. Louis neutron-bombarded UNH, using the Wet Fluoride Process, carried out at 2, 4, 8 and 16 days after the end of bombardment. Apple described the semiworks layout in the cyclotron laboratory, which can handle 30 pounds of charge material. Sutton next related the work of his group on metal solution problems. They are now studying the excess acid needed to give a clear solution at the end of the solution process. He said that some work has been done on

improving the characteristics of precipitates. Willard and Boyd followed by describing their work on adsorption processes using columns.

The meeting ended with a discussion about the Site X layout and tentative plans, led by Cooper. Because Fermi found that k in the West Stands pile is larger than anticipated, Greenewalt has decided for the sake of expediency to build an air-cooled, experimental pile, rather than a helium-cooled larger pile, at Site X. Moore, Wheeler and Whitaker of this Laboratory, in cooperation with du Pont's pile design group, have agreed on the fundamental features of the air-cooled pile.

The pile, designed to operate at a power level of 250 kw, will consist of a block of graphite with hundreds of horizontal channels running from front to back. The channels will contain strings of uranium cylinders, each cylinder encased in aluminum. Rods to control the chain-reaction will enter through one side. Cooling air will flow through the channels; and, whenever the cylinders have been irradiated sufficiently, they can be pushed out the back side with fresh cylinders. The irradiated cylinders will be carried by a chute to an underground water canal, where they can be stored until ready to be transported to the connecting chemical separation plant.

Cooper gave some specifics: 52,000 cubic feet of air per minute will be required for cooling, which will insure the maximum temperature to the uranium will not exceed 100°C . According to Wigner and Weinberg, who made the calculations, the graphite block should be a cube, 24 feet on a side, weighing 1,500 tons and containing 1,248 channels eight inches apart; about 60 tons of metallic uranium in the form of cylinders about one inch in diameter and four inches long are necessary to maintain a chain reaction. As for experimental facilities, there will be six holes through the pile. The pile will be surrounded by several feet of concrete for shielding.

A physicist's lab will be on top of the pile and a chemist's to one side. No experiments are to be conducted in the operating areas but there will be additional laboratory space outside the enclosure. When several of us said that we each would want two men working there full time, we all agreed that the laboratory area will have to be larger than the 24 feet x 40 feet proposed. In addition, Coryell requested that he be provided with

2/19/43

a small, shielded room near the pile so that he can get fresh, hot metal directly.

After lunch with Wilma, Helen went to a shower for Frances Burton and Frances Garrison (Warren M. Garrison, her husband, is a group leader under Burton) at Phyllis Connor's.

There was a Policy Meeting of the Laboratory Council in the late afternoon, attended by Cantril, Compton, Cooper, Doan, Fermi, Franck, Hilberry and Peterson. Compton opened the meeting by stating that since the meeting day before yesterday a problem has come up calling for immediate attention. "As you know," he said, "we now operate Site X and must decide what goes there, with especial reference to chemistry. Buildings must be specified. Construction starts Monday at X if authorized by tomorrow." He then told the group that the big problem is to decide how work for the immediate future should be split up between Site X, Argonne and the Chicago campus. According to General Groves, the current program will continue for years regardless of utility to the war effort. It was Compton's feeling that the University in principle is willing to cooperate but is not prepared to get involved in a permanent building project on the campus at present and will not tolerate a temporary-type construction. Hence we should look to Argonne as our permanent quarters. He went on to say that regardless of what facilities are planned for Argonne Laboratory, the most immediate decision should concern chemistry needs at Site X. We should keep in mind that most research should remain at Chicago, whereas only those things that must be carried out near a high-level pile should go to Site X.

Franck said that Coryell would send about two-thirds of his group to Site X and so would require space adjacent to the pile and 2,000 square feet of laboratories elsewhere. In addition, he said, Boyd needs a laboratory at the pile for large-scale adsorption work, and Burton needs to work close to the pile. Hilberry thought that the discussion indicated that only such things should go to Site X as are absolutely needed to be close to a high-level pile. Chemistry, for instance, would be represented by a trouble-shooting group

2/19/43

on separation and decontamination, and nearly all of the health group would be there. The discussion turned to Argonne again, and it was brought out that the Army will not build houses at the site—only barracks and dormitories. Compton offered to tackle University Administration to see if there is a chance to put up campus buildings to house the participants in the whole enterprise, and Hilberry suggested that there is nearly a whole city block, at present unoccupied, in back of the Service Building. Compton announced that it was time for dinner and that the Council should think about space requirements overnight, with special emphasis on chemistry needs.

Our troops are having more trouble in Africa, having yielded three more towns to Rommel.

Saturday, February 20, 1943

Because of the erratic carrying of 93 by bismuth phosphate found by Thompson at tracer concentrations, Cunningham and Werner today tested the carrying of 93 by bismuth phosphate at a higher ratio of 93; the bismuth to 93 ratio in their experiment was $2.5 \times 10^5:1$. In this experiment they used 5 λ of 93^{239} tracer containing about 5×10^9 counts per minute per ml. They precipitated the bismuth phosphate from a 20% UNH 2 N H_2SO_4 solution and find in two experiments that only 27% of the 93 is carried by the bismuth phosphate.

I sent Compton, with copies to Allison, Cooper and Franck, the following memorandum on personnel requirements:

"At Mr. Allison's request I am summarizing for you my estimates as to the rather immediate needs in additional men for the carrying out of the contemplated work in 49 extraction, concentration, purification, etc., at Chicago and Site X:

2/20/43

	No. men <u>on hand</u>	No. additional <u>men needed</u>	Total no. <u>men needed</u>
I. Extraction Group			
1. General Work	4	6	10
2. Fluorine work	4	2	6
3. U ²³³ work	1	4	5
II. Purification Group			
1. Microchemists	3	2	5
2. General	4	2	6
3. Physical	4	1	5
III. Metal Production Group			
1. Microchemists	1	2	3
2. General	<u>2</u>	<u>2</u>	<u>4</u>
Totals	23	21	44

"About half the men on hand are junior men (bachelors and masters men), and about the same fraction of junior men is contemplated for the additional men needed. At the present time, due to the serious shortage of men in the 'Extraction Group,' a number of men in the 'Purification Group' are working on extraction methods and largely on the 'Wet Fluoride method.'

"Requests for ten of the additional men needed have already come through your office, and the necessary authorization for Mr. Moulton's contacting them was received. Of these ten men, we have received acceptances of positions with us from three, while five according to our latest information definitely cannot come with us, and two have not yet been heard from. However, I am sure that, if you should authorize it, we shall be able to find the necessary number of men of the ability and training which we believe we need.

"The requirements in men for Site X, all of which are to be taken from the above list, seem to be about as follows:

2/20/43

<u>Function</u>	<u>Number of men needed</u>
1. Concentration of final product	4
2. Extraction and decontamination development work with chem. engineers	6
3. Trouble-shooting in connection with extraction plant	3
4. Development of control work with chem. engineers	2
5. UF ₆ -plant work with chem. engineers	2
6. U ²³³ work with chem. engineers	3
7. 93 ²³⁷ work	<u>1</u>
Total	21

"It is contemplated, in order to fill these needs, that the 'Extraction Group' would move, more or less in its entirety, to Site X. Nearly all of the men in the other two groups would remain in Chicago. This is somewhat of an approximation to the actual situation since some of the men in the present 'Purification Group,' e.g., some microchemists, should go to Site X, and some of the men in the present 'Extraction Group,' e.g., some fluorine-trained men, should remain in Chicago with the other groups."

Sunday, February 21, 1943

In the afternoon Helen and I took a long walk out to the 71st Street district.

Monday, February 22, 1943

Cunningham and Werner precipitated about 0.1 microgram of 94 as the insoluble fluoride. They isolated the precipitate by centrifugation and then added about one microliter of zirconium nitrate (concentration of

2/22/43

about 50 mg per ml in 3 N HNO₃) and the precipitate was observed to dissolve. Upon the addition of more HF a precipitate reappeared. This observation is of importance in connection with the Wet Fluoride Process where the lanthanum fluoride precipitate containing 94 will possibly be put in solution by treatment with zirconium ion.

Today Cunningham and Werner started isolating 93^{237} from the residues resulting from the workup of the large St. Louis neutron bombardment, Chicago II (100,000 microampere-hours, September 9-October 25, 1942).

Richard S. Rosenfels began working as a Research Associate in Section C-I today, coming from Weyl-Zuckerman and Co. in Stockton, California. He is trained as a plant physiologist but has experience in microchemistry. I am having him work in Room 13 with Kirk on the metal production problem.

Robert B. Young started to work with us as a Laboratory Helper today.

I received a letter from Lingane at Harvard University declining my offer of a position. He has accepted an assignment on another NDRC project, which he will be able to carry out at Harvard without curtailing his teaching program.

Gofman sent a letter from Berkeley, saying the cyclotron has broken down and his group is in need of some silver (93^{239}) tracer. He asked about the possibility of getting 300 grams of X nitrate (UNH) from the St. Louis cyclotron, if such has been near the target; otherwise he would like to send them the UNH for a special bombardment. He concluded his letter with the remark that they are going to need the tracer very badly and cannot depend on the Berkeley cyclotron for some time. In response, I airmailed Gofman a solution of purified 93^{239} , equivalent to 300 grams of irradiated uranium, and informed him of this by wire.

I received a copy of the Metallurgical Project Report covering the period ending February 15 (Report No. CA-485). It listed the names of 18 new Research Associates who were employed during the last month. In addition to Paul Kirk and Edwin Orlemann from the University of California

2/22/43

and Norman Davidson from the Illinois Institute of Technology, who are new members of my Section, there are such people as Walter W. Armstrong, Joseph H. Balthis, Carl M. Olson, James H. Peterson, Harold P. Riley and J. Bartlett Sutton, chemical engineers from the du Pont Company, David and Jane Hall from the University of Denver, Philip Morrison, who received his Ph.D. in physics with Oppenheimer at Berkeley, and Roderick W. Spence from the Chicago campus of the University of Illinois. In all, 77 persons were hired, whereas 26 employees resigned or were cut off. The Report reviewed the work of the month at the Met Lab, which I quote:

"Operation and development of piles. Experiments with the chain-reacting pile have supplied much useful information. The pile is being used to test the purity of metal samples. The temperature decrease in k per central cell per 100°C was determined to be 1.3×10^{-3} . A neutron thermometer was developed and showed 380°C for the thermal neutrons in the lattice. The neutron spectrum in the metal was found to extend with considerable intensity up to 4 Mev. The effect of varying the lattice structure was studied (increased metal content of cells, rod geometry, etc.). Cross sections of substances for thermal and resonance activation are being determined. Theoretical studies in conjunction with old and new experimental data are leading to better values of the constants essential in any pile design. Plans for the water-cooled pile are being developed actively using both theoretical data and experimental tests. The use of water from a natural source passed once through the pile is being seriously considered.

"Analytical methods. Methods of analyzing for impurities in the metal are continually being improved. Methods used include chemical methods and three types of physical methods: spectrographic, polarographic, and shot-gun. The last is a direct test of neutron absorption by the ether-extracted residue from samples dissolved in nitric acid, and is proving satisfactory for most elements, although sensitivities need to be improved.

"Effects of irradiation on materials. A striking result is that irradiation produces hydrogen peroxide in water only if dissolved oxygen is present. A program is being instituted for studying the effects of prolonged bombardment of graphite by fast neutrons.

2/22/43

"Investigations on fission products. Progress has been made in determining gaseous ancestry of product chains, in separating rare earth products, and in determining β and γ ray energies. Improved tables of activities, element by element, as a function of time of cooling are given. Improved estimates of rates of β and of γ energy production, element by element, for a cooling pile, have been made. Capture/fission ratios in cyclotron bombarded material are being measured. By heating bombarded metal above its melting point in graphite, all elements, except those resembling the metal and one or two others, are almost completely removed.

"Health, Radiation and Protection. Hospital patients irradiated with x- and γ -rays are being studied. Extensive animal experimentation is being carried on (distribution of radioelements in tissues, effects on health of irradiation by fission products or pile radiations, effects of radio-xenon and of breathing metal dust, toxicity of metal, effect of x-rays on Drosophila egg survival). Instruments are being developed for measuring physiological intensities of β , γ , and neutron irradiations separately. Radiation hazards from metal handling, from chemical residues, radium sources, pile and cyclotrons have been surveyed. Members of the Health and Physics divisions have made needed studies and collaborated with the engineers in plans for safe radiation shielding at plant sites. Particular attention was given to γ -rays, emanating from active sources or from radioactive gases, and scattered by air molecules to considerable distances. Clinical and medical work gives a good health picture for the project. Need for extra care in handling radium sources was found."

This report does not include the work of my Section, which is covered in reports of more restricted circulation.

Perlman and I attended the regular Laboratory Council Information Session on Chemistry; others present were Adamson, Boyd, Burton, Cannon, Cohn, Cole, Compton, Cooper, Coryell, Doan, Fermi, Franck, Hilberry, Johns, Mulliken, Spedding, Sugarman, and Wigner. Spedding and Johns gave a summary of current work at Ames, and Coryell and Burton reported on the activities of their sections.

2/22/43

I reported on the work of the Chicago and Berkeley 94 chemistry groups, reviewing the main extraction and decontamination methods (wet fluoride, adsorption, phosphate, acetate). Next, I mentioned the possible interference of corrosion products in the Wet Fluoride Process and the fact that bismuth phosphate has been shown to carry 98% of tracer 94 in a crystalline precipitate from 20% uranyl nitrate solution 1 N in H_2SO_4 . I also cited the work of the Berkeley group with the acetate method which reduced fission activity by a factor of 150,000 in three cycles. In reply to a question by Fermi, I pointed out the increasing importance of the microchemistry work in checking out separations processes at production levels of 94. I also reviewed our program on purification of 94 and plans to produce the metal.

Du Pont officials held a conference with me, at which I presented the status of the Wet Fluoride and other alternative processes. The possibility of working up combinations of the best features of the known processes was reviewed, particularly from the standpoint of the equipment requirements and the desirability of eliminating moving parts, such as centrifuges and motors. In this connection, the possible equipment advantages in the adsorption and electrolytic processes were emphasized. I said that we have no immediate plans for further work on the electrolytic process. Also, I learned that du Pont does not wish to be concerned with the purification and metallurgy of 94 and will so inform General Groves.

Willard, together with Boyd of the Analytical Section, sent a memorandum (MUC-GTS-32) to Charlie Cooper giving a summary of the work done by the Project to date on adsorption of ions from solution by inorganic adsorbents. Results were given of the separation of 94 with columns of Hyflo Super Cel, silica gel and several inorganic salts. It was proposed that further intensive work be done to determine whether any of these materials can be used on a large-scale process for separation of the products of the piles.

Helen went to the West Side Y (101 S. Ashland Avenue) in the morning and to the 63rd Street Y, just around the corner from Woodlawn Avenue, in

2/22/43

the afternoon; however, no girls were present because of Washington's Birthday.

I attended the Chemistry Division Seminar in the evening. The program was put on by Boyd's Section and included reports by Potratz on his analysis of the purity of pile components and by Fred on spectrographic analysis for light element impurities.

February 23, 1943

Brown, Hill and Bohlmann performed another distillation experiment with UF_6 which has been bombarded with neutrons at the St. Louis cyclotron (bombardment no. F-6-3)—this is their third experiment of this type. In this case the UF_6 was put in an oven at $72^{\circ}C$ for a month in order to give any oxidation or reduction process that was taking place ample time to attain equilibrium. When this UF_6 sample was distilled, it was found that after essentially all of it distilled, left in the undistilled residue was about 5 percent of the 94, in agreement with the second neutron-bombarded UF_6 experiment.

In connection with our basic patent application on 94^{239} , to be taken out in the names of Segrè, Kennedy and me (Case no. 61) to protect the federal government's post-war right to use it as an energy source, the patent attorneys want us to include a description of a sustained chain-reaction that can be produced as a source of energy, using a mixture of 94^{239} and a moderator. York of our legal department has prepared a patent write-up and forwarded a copy to Lieutenant Baird, the patent attorney in Berkeley. Since York feels that the patent application requires some specific examples of working concentrations of 94^{239} and pertinent devices, I sent a letter to Segrè and asked that he and Kennedy prepare some graphs similar to the ones I enclosed, e.g., optimum concentrations for 94 in a sphere of water that would achieve criticality. I concluded the letter by saying that this request will give rise to a lot of work for him and Kennedy, but that I have already given it a fair amount of time and I think that it is probably our duty to do so.

2/23/43

Charles Cooper has asked for an estimate of the number of grams of 93^{239} present per gram of 94^{239} in a pile as a function of time of operation and time after shutdown. Brown has now prepared a table, which I sent to Cooper today. As an example of what it shows, for every gram of 94^{239} in a pile that has operated for 40 days and nights, there is 0.083 gram of 93^{239} at shutdown and only 5.6×10^{-6} gram at the end of 32 days.

Willard sent a memorandum (MUC-GTS-37) to Cooper giving the results of tests on the corrosion, metal coating and lanthanum fluoride dissolving problems connected with the wet fluoride separation method, information requested by Cooper on February 5. Some of the conclusions are that lanthanum fluoride can be satisfactorily dissolved in acid solutions of zirconium, that tracer amounts of 94 can be oxidized in these solutions, that the presence of corroding steel in oxidized solutions leads to reduction of tracer amounts of 94, that proposed coating substances for uranium will not result in excessive losses of 94.

Helen visited the Metro YWCA (59 E. Monroe) today.

In the evening we held our regular meeting of Research Associates in my office. Cunningham discussed our views on the oxidation states of 94 and the molecular species present in ionic solution. I summarized my ideas on the production of 93^{237} in the planned chain reacting piles from the $U^{238}(n,2n)U^{237} \xrightarrow{\beta^-} 93^{237}$ reactions. I surmised that an appreciable quantity of 93^{237} will be produced.

Wednesday, February 24, 1943

The report entitled "Report for Period Ending February 20, 1943, Technology-Chemical Engineering and Separation Processes" with the report number CN-486 was issued. This includes reports of the work of W. Q. Smith's Section and J. B. Sutton's Section, covering the work of the du Pont engineers. Noteworthy is the report of work in Smith's Section on a run in the semiworks equipment using the Wet Fluoride Process on some neutron-bombarded UNH. The results are generally satisfactory with the

2/24/43

exception that in the stainless steel equipment, the sulfur dioxide reduces some of the uranyl nitrate and potassium dichromate resulting in the formation of insoluble UF_4 . This, of course, would be intolerable in a plant scale operation and suggests that some changes are needed in the reducing agent.

I sent a letter to Fontana in Berkeley telling him that he will be receiving a patent application from our patent attorney here, Foster York, covering the work on ether extraction of uranium from large amounts of thorium. I said it would be written up under his name as the inventor, inasmuch as he did practically all of the experimental work and it was his original idea to try the method. I explained that such patents are necessary to protect the Government with respect to all the procedures that are worked out by scientists on the Project.

Another letter today went to Rollefson in Berkeley, expressing the hope that he is having success in his program to develop spectrographic methods of analysis for small amounts of light impurities in 94^{239} . I told him that in a few days Cunningham will mail him about 10 micrograms of 94 in solution as the pure nitrate. I asked to hear about his progress with this problem since it is beginning to look more and more as if the spectrographic method will be our main hope for the solution of the extremely difficult analytical problem that faces us.

In reply to Patton's letter from Cornell University last week, I emphasized that we need him for his ultramicrochemical abilities in development work of the most challenging nature. I again cautioned him regarding the secrecy of our negotiations and said that Kirk will clarify some of the other questions raised in his letter.

Peter Heussenstamm sent me an announcement from Madison, Wisconsin, that a Chicago reunion of UCLA chemists living in the Midwest is being planned for April 17 and 18, following the ACS convention in Detroit. He listed ten men at Northwestern who are being notified (Blacet, Blaedel, Lewis, Pitts, Roof, Siegel, Skei, Volman, Weiss, White), as well as Brady, Campbell, Coryell, Engelkeimer, Jarrett and me at Chicago, and a few others

2/24/43

at the University of Minnesota and the University of Wisconsin. In my reply I said that Thompson and Perlman here, and Vance Cooper in Morris, Illinois, soon to join us here, are other Bruins who probably would be interested.

This evening Helen and I had dinner at the Miles Leveretts'.

There was a Laboratory Council Policy Meeting attended by Allison, Cantril, Compton, Cooper, Fermi, Franck, Hilberry and Major Peterson. Compton summarized the results of a conference with du Pont officials about the Clinton Engineer Works at Site X. Concerning the division of responsibility, du Pont will design and the Met Lab, as the operator, will check design and be responsible for the adequacy of information on physics and chemistry. Whitaker, as the Met Lab's representative and sub-Project Director for Site X, will make final approvals. He mentioned that du Pont has now decided to build water-cooled piles for 94 production at Site W in the State of Washington; they are getting data on corrosion, fabrication and lattice geometry. Steps are being taken to acquire control of Site W. Wheeler is assigned by us to work with Greenewalt and will be devoting most of his time to Site W problems. Franck, in his report on the work of the Chemistry Division, mentioned my need for 22 men for Site X. There were discussions on the advisability of the Ames and California groups coming to Chicago; it was agreed that the work at Ames should continue on the present scale. Allison indicated that Professor A. R. Olson of the Berkeley group was here today to discuss the Berkeley chemistry program. With regard to the California group, Groves wants them in Chicago; however, some more may go to Site Y if there is a general breakup. It was felt that of the 28 people in the California group the younger people might be readily transferred but the older men, professors, etc., would not want to but they may not be spending much time on our work anyway. It was thought that perhaps some of the California men should come to Chicago to discuss matters—perhaps Compton should write to Latimer and tell him what is going on.

2/24/43

U.S. troops were finally able to stop the Axis drive in central Tunisia.

Thursday, February 25, 1943

Cunningham and Werner have been working since Monday on the isolation of 93^{237} from the second large St. Louis neutron bombardment of UNH, from which they isolated the 94^{239} last December. We estimate that this should contain about 3.5 micrograms of 93^{237} but the final fraction isolated by Cunningham and Werner contained less than a microgram of 93^{237} . The reason for this discrepancy is not clear.

I received a copy of a memorandum distributed by Cooper, transmitting an outline he has asked Sutton to prepare on engineering information needed in evaluating adsorbents for use in separations work. He asked for a meeting in the New Chemistry Building at 9:00 a.m., Tuesday, March 2, to formulate a program and assign responsibilities. Those invited are Boyd, Franck, Smith, Sutton, Willard and me.

I sent a letter to Vance Cooper in Morris, Illinois, expressing my pleasure that he has decided to come with us. I explained that our personnel director will write to him and to his home office regarding a leave of absence.

I attended a meeting at which Greenewalt outlined the production and processing specifications of water-cooled piles to be erected at Site W. Following Wigner's design, it is proposed to construct each pile roughly in the form of a cylinder and lying on its side. A two-foot graphite reflector will be used, and aluminum tubes will run longitudinally through the pile structure containing flowing water as a coolant. The fuel will be uranium "wieners" in aluminum jackets. It is estimated that three such piles operating at 250,000 kw (200 tons uranium metal, average 1,250 kw per ton, 2,500 kw per ton in center column) will produce about 600 grams of 94^{239} daily, and in 100 days the concentration of 94 to uranium will be about one part in 4,000. There would then be a wait of 60 days after

2/25/43

shutdown to allow the 93^{239} and fission products to undergo decay. One of the main problems will be the unwanted production of radioactive xenon. To dilute the xenon effluent, air will be introduced at the bottom of the stack.

Franck wrote a letter to Gofman saying that he and Compton agree that the people in Latimer's group should have more information about the Chemistry Division activities at the Met Lab. So he invited Garner or Wahl to come every fourth week to the Monday meetings when the Laboratory Council discusses questions related to information provided by the Chemistry Division. He asked Gofman to talk it over with his colleagues and find out who will be available to present a progress report at each such meeting.

In the afternoon I attended a meeting of Chemistry Division Section Chiefs (Boyd, Burton, Coryell) with Franck in his office to discuss the 94 purification and metal production problem.

Fulbright sent me two drawings from Washington University showing the packing arrangements of our current UNH cyclotron bombardment (Chicago IV). Included is a table showing the relative activities found in the gold monitor placed among the boxes. These monitors are in sets, each set consisting of one bare and one cadmium-wrapped piece of gold sheet. His letter says that the present bombardment is going well and that the sample has accumulated 66,000 microampere-hours since he started the irradiation February 9.

Ghiorso told me about the instrumentation meeting he attended today. About twenty persons from all parts of the Laboratory were there to discuss what radiation instruments are needed on the campus and at Clinton. The topics were of a wide variety: scalers (Ghiorso believes that for the present state of the art, a scale of 8 with high speed is more reliable than 64 with a low-speed recorder), G.M. tubes, alpha counting with beta background, counting-rate meters, portable survey meters, alarm meters, pocket chambers, film badges, radiation frisking, the monitoring of pile-room ventilating air, water activity, a proportional counter amplifier, a portable neutron meter, stack monitoring, a table-top survey meter

2/25/43

(Ghiorso told them that we are using an alpha counter in the New Chemistry Building for this application; he, Wilson and Overbeck will look into other possibilities), and a neutron thermometer.

Perlman conducted tonight the seminar for Research Assistants. He had several of the research assistants reports on their individual research programs. James reported on 94 extraction methods and the half-life determination of 94^{239} . Jarrett and Crawford reported on radiation counting methods; Koshland on extraction methods for 94; Turk on adsorption methods for extracting 94; La Chapelle also on adsorption methods; Hill on volatility methods for extracting 94; Bohlmann on distillation of uranium and 94 fluorides; Werner on microchemical investigations; and Knox on aqueous extraction procedures.

Rommel has received his first defeat in his Tunisian drive. Today came the first reports that Churchill has been suffering from pneumonia.

Friday, February 26, 1943

Since the uranium in the production piles will be covered with coating metals, Thompson has made tests of the effect of these on the Wet Fluoride Method. He has tested a number of coating metals, such as tin, copper, nickel, aluminum, lead, and finds that the effect of these results is less than a 10% loss of 94 in the process.

The Chemical Engineering Section has found that when the Wet Fluoride Process is carried out in the stainless steel semiworks equipment, the SO_2 reduces the uranium. The SO_2 , which is thermodynamically capable of reducing UO_2^{++} to U^{+4} , failed to do so on the laboratory scale but does so in the presence of steel and the agitation that takes place in the semiworks equipment and in the presence of the corrosive $HF-HNO_3$ solution. This causes the precipitation of large amounts of UF_4 and this of course is very undesirable on an engineering scale. It is necessary, therefore, to find a reducing agent capable of reducing dichromate ion and 94 but incapable of reducing UO_2^{++} . Preferably the reduction of 94 in the

2/26/43

presence of dichromate ion should take place at a temperature of 50°C or less as corrosion problems become severe at higher temperatures. Koshland has tested a number of potential reducing agents in the presence of UNH to ascertain their effectiveness in reducing dichromate ion and 94. He has tested nitrite ion, hydroquinone, ferrous ion, H₂O₂, hydroxylamine and arsenious acid. Several of these have good prospects. Arsenious acid gives complete reduction of the 94 in 20 minutes at room temperature and tests in the presence of corrosion products of the steel do not seem to lead to the precipitation of UF₄ in the case of "25-12" stainless steel. However, in the presence of "18-8" there is some precipitation of UF₄. Since the 94 reduction by arsenious acid is rapid, it may be possible to work in 18-8 steel by adding cold K₂Cr₂O₇ to the solution after all the 94 has been reduced, which would not oxidize the 94. The K₂Cr₂O₇ might then prevent the corrosion.

Merlin Peterson of the Technical Division contacted the du Pont Experimental Station (the Grasselli Chemicals Department) in Cleveland, Ohio, regarding materials that might be used to preferentially adsorb cerium. Today Cooper sent me, Boyd, Sutton, Smith and Franck a copy of a letter from the Experimental Station regarding two 100-gram experimental samples of silica (coded GRS-440-52,82) that may be of some interest to this problem. Cooper turned the samples over to Boyd but cautioned that they should not be used until after the planning meeting that is scheduled next week to formulate a program.

Recently Hamilton sent us from Berkeley a deuteron-bombarded uranium metal target of 35,000 microampere hours, one-third of which is to be returned to Gofman. Today I received a letter from Gofman asking us to ship his portion, as he is now in a position to use it.

Kennedy visited the Met Lab again today to line up counting equipment, etc., for his move to Site Y.

Brown and I sent to our patent attorney, York, an abstract on the "Chlorine Method for Isolating Element 94." In this process, we said,

2/26/43

gaseous chlorine is used to volatilize uranium away from element 94 at 350°-450°C. After the uranium is removed, the 94 can be volatilized by increasing the temperature of the reaction vessel to about 800°-900°C; fluorine can also be used. Few fission products follow the 94.

I wrote a letter of encouragement to Baumbach, saying that Compton has contacted Washington and a letter from a proper official will soon be sent to Mr. Freeman. In addition, I wrote Dr. John F. Flagg of the Department of Chemistry at the University of Rochester, a friend who has experience in artificial radioactivity and tracer techniques, to offer him a position with me here at the Met Lab.

Newspapers report that the Allied armies are blasting Rommel's rear guard in Kasserine Pass in Tunisia.

Saturday, February 27, 1943

Thompson has succeeded in carrying through successfully a complete oxidation-reduction cycle in the bismuth phosphate method. Using neutron-bombarded UNH from the third large St. Louis bombardment (Chicago III, completed January 23, 1943) as his source of 94^{239} and fission products, he dissolved the UNH and precipitated bismuth phosphate under standard conditions. He dissolved the bismuth phosphate in 10 N HNO_3 and then oxidized the 94 with $\text{S}_2\text{O}_8^{--}$ ion plus Ag^+ ion. From this solution he precipitated bismuth phosphate and separated this by centrifugation, then reduced the oxidized 94 in the filtrate with SO_2 for a half-hour and again precipitated bismuth phosphate. This bismuth phosphate was dissolved in 10 N HNO_3 , then diluted and by the addition of phosphoric acid reprecipitated. This precipitate was found to contain about 0.76% of the original fission product gamma activity. The bismuth phosphate was then dissolved in 6 N HCl and a small amount of lanthanum fluoride precipitated so that the 94^{239} alpha particles could be measured. Although he found only about 30% of the alpha activity corresponding to the 94^{239} , he accounted for the remainder by the fact that the reduction with SO_2 was not complete. He went back to that solution and added H_2O_2 to complete

2/27/43

the reduction, then precipitated lanthanum fluoride to carry the 94^{239} and found the remainder of this alpha activity in this fraction. This, then, represents a complete oxidation-reduction cycle with the bismuth phosphate process, indicating, although there were some complications, that the yield of 94^{239} is satisfactory and the removal of fission product gamma activity is greater than a factor of 100 (there was negligible fission product gamma activity in the last lanthanum fluoride precipitate used to recover the remainder of the 94^{239}).

Today English sent a memorandum (MUC-GIS-40) to F. B. Vaughan in the Technical Division summarizing the characteristics and use of instrumentation for the measurement of alpha, beta and gamma radiation in connection with the chemical processes for the extraction and decontamination of 94. This information is needed in order that the chemical engineers might become familiar with the instrumentation required to make assays of the solutions during the operation of their chemical extraction processes on the plant scale.

I sent a letter to Winstein at UCLA urging again that he try to join us some time in the summer on a six-month leave of absence. The Project, I said, is undergoing further expansion, it appears that the work here will go on for quite some time, and we are finding it more and more difficult to find research men with leadership qualities.

Our first laboratory "disaster" occurred last August 25 when Perlman's beaker of 94^{239} in water solution was accidentally smashed. Today was our second. It concerns the deuteron-bombarded uranium target that Hamilton sent to us. In dividing it in order to send Gofman his one-third share, an attempt was made by Covey to melt the silver solder that binds the uranium metal sheet to its backing. In doing so, the uranium and presumably 94 became oxidized, rendering its contained 94^{239} useless for experiments on the metallic state of 94 as contemplated by Gofman; it can, of course, be used for solution tracer studies. This bombardment has a nominal value of \$5,000. I regret the incident and will have to write a letter of explanation to Gofman.

2/27/43

Helen attended the budget-month luncheon at the YMCA, and tonight we both dined at John Howe's (6105 Kinbark Avenue). John is a group leader, and Marilyn is a research assistant in the Technical Division. Later, the four of us went to a dance at the Quadrangle Club.

Sunday, February 28, 1943

Helen and I went to the movies at the Tower Theater on 63rd Street near Blackstone Avenue, where we saw "George Washington Slept Here," with Jack Benny and Ann Sheridan.

MARCH 1943

Monday, March 1, 1943

Miles Leverett distributed a memorandum to all Section Chiefs listing the reports pertaining to Site X that are now available in a file in Room 202 of Eckhart Hall.

Rollefson wrote from Berkeley that the grating spectrograph has been in operation practically all of February. Electrical arrangements for both arc and spark excitation have been set up, and spectra of various substances are being photographed using samples ranging from a tenth of a microgram down to a few hundredths of a microgram. He is using copper electrodes at present as the graphite on hand is not sufficiently pure. Samples of 94^{239} from us are now welcome; he feels that with reasonable luck analyses for impurities can now be made.

I sent a reply to Rollefson's letter, saying that all of us here are glad to learn of his progress. I said that although we have a fair amount of 94^{239} in the process of purification, it will still be a week or so before this purification is completed. At that time we will ship ten to twenty micrograms; in the meantime, we will airmail today about four micrograms from a previous purification. I mentioned that Eastman has some very pure graphite made for the Project which he might find satisfactory. I suggested that it would be an excellent idea if he could send me a short description of the experimental work so far to be incorporated in our monthly report.

"It will of course be necessary," I continued, "to develop facilities here at Chicago for doing spectrographic analysis in connection with this problem of light impurities in 94^{239} . At least I think that it would be necessary, since Berkeley is so far away; I would like to have your opinion on this. I am hoping that you will be able to come to Chicago for a short time this spring to help us get started on such a program. I had in mind

3/1/43

a stay of only a few weeks, but if you cared to stay here longer to help us, either then or later, we would like to have you for as long as possible." I then said that I thought Harold Dodgen has been of great help and wished there might be another man or two who could be put to work with him to be trained for future employment with us. I also asked him to suggest some of his former Ph.D. students who might be willing to join our group.

Norris W. Embry, who has been working as a laboratory assistant in my Section, resigned today. He is an English major and showed little aptitude for laboratory work so Covey is happy to see him go.

I received a copy of a memorandum from Sutton to Cooper, stating that a preliminary planning discussion for the meeting tomorrow on the subject of adsorption processes has been held with Willard, Boyd and Arthur W. Adamson. At this conference it was agreed that the adsorption work should be divided as follows: I. Preliminary scouting; II. Tests in adsorption columns; and III. Engineering.

Helen went to a Girl Reserve meeting at 63rd Street in the afternoon.

At the Chemistry Division Seminar, held in Room 251 Ryerson Laboratory at 7:45 p.m., my Section was in charge of the program. I described, in outline, the procedure for separating 250 grams of 94^{239} from a ton of uranium containing 10^7 curies of fission products through the series of steps that we have labelled (1) extraction, (2) decontamination, (3) concentration, and (4) purification. Willard summarized the chemistry of 94, describing its fluoride-insoluble and fluoride-soluble oxidation states and the oxidizing agents capable of effecting the change from the former state to the latter; Cunningham described his determination of the half-life of 94^{239} ; and Brown summarized his work on the fluoride volatility method.

A Laboratory Council Information Meeting was held today, attended by Allison, Cole, Compton, Cooper, Creutz, Doan, Fermi, Franck, Hilberry, Leverett, Miles, Mulliken, Peterson, Smith,

3/1/43

Spedding, Sutton, and Wollan. Progress reports on the laboratory at Site X and the Technical Division here were presented.

Whitaker, who is the sub-Project Director for Site X, said that the overall design for the laboratory is not ready yet because the data were made available only last Tuesday. In general terms, the laboratory will be situated in a valley 1,000-1,500 feet wide, and there will be a 1-1/2 mile rectangular-shaped fence around the whole layout. In the rectangle will be 30,000 square feet of space devoted to chemistry, alongside which will be two stacks for off-gases from the pile and the separation plant. The other half of the rectangle will be zoned for the separation plant, the pile adjacent to it, and a building of 8,000 square feet for carbon preparation and carbon and metal testing. Two shop buildings will be located outside the fence. Everyone who knows what is going on will live in a village ten to thirteen miles away. The village will also contain the administration and hospital buildings. Whitaker then entered into a discussion with others on the design of the pile, essentially that designed by Wigner and Weinberg. Spent fuel from the pile will drop through a chute into a moat containing water to a depth of eight feet. The uranium cylinders can be moved underground using buckets and be handled with tongs. Water is a good medium for cooling, visibility and shielding.

Cooper took over and showed a diagram of the chemical separation plant. Along one-half the length of the building will be a series of cells, the one being closest to the pile (which will be located immediately alongside the building) to be used for dissolving the uranium fuel cylinders when it is time to extract the 94 and fission products. Successive cells will handle diminishing volumes of solutions, the last yielding the end product for the laboratory. The wastes from the cells will flow into disposal tanks by gravity. There will be two types of tanks, a few small ones for fission products and a number of 50-foot diameter ones for the process residues. At the end of the building farthest from the pile will be a laboratory for analysis pertaining to the operation of the plant, and adjoining it a shielded counter room. All cells will be ventilated by air that is disposed of in a 200-foot high stack.

3/1/43

The second half of the meeting was spent in hearing about the work of the Technical Division. Creutz reported for the metallurgical group and Wilson discussed the work of the ionization chamber group under Jesse and the pile control group under Overbeck. Smith touched on the Wet Fluoride Process and said that there is an increased confidence in this process as a result of their work, but it has been found that the reducing agent, SO_2 , is not satisfactory with stainless steel and maybe it is too powerful anyway. No final decision has been made as to what reducing agent to use. The intention is to use 25-12 Cr-Ni stainless steel for the plant. Franck asked if we will be able to change over from one extraction method to another at Site X if a better method is developed meanwhile. Cooper replied, saying that it would take considerable time when the method is once fixed, except for a change from one to a second sub-variety of the Wet Fluoride Process. Thus far, the equipment chosen leaves the method pretty flexible, except that adsorption would require very different equipment. Smith said that his semiworks group will work up the St. Louis neutron-irradiated UNH by the Wet Fluoride Process. The concentrates containing the 94 will be turned over to chemists in my Section for the isolation of the pure 94^{239} . Sutton said that his Section is working on the Wet Fluoride Process and the Bismuth Phosphate Process and is getting into the Adsorption Process. In response to a question by Franck, Cooper indicated that the Sodium Uranyl Acetate Process is no longer considered as a primary separations process but might be promising as a next step following another separations process. Cooper indicated that there will be an extensive report on the Adsorption Process at the next monthly Council Information Meeting on Technology.

Tuesday, March 2, 1943

Davidson and Knox have tested the effect of steel corrosion in the Wet Fluoride Process and find that it leads to the reduction of 94 even in the presence of unreduced dichromate; neither appreciable corrosion nor 94 reduction was noted, however, in the presence of 25-12 stainless steel.

3/2/43

Koshland tried several reducing agents for the purpose of reducing 94 without at the same time reducing and causing precipitation of uranium; arsenious ion seems to be the most promising.

"Report for February 16-28, 1943. Chemistry of 94, University of Chicago Group" with the report number CN-503 is being issued with the following content. Brown and Davidson have carried out calculations on the concentration of 93^{239} and 93^{237} to be expected in pile material as a function of time after shutdown and time of operation (important because 93^{239} constitutes the largest single beta and gamma emitting by-product during the first few days after shutdown). The calculations show that assuming reasonable values for yields of 93^{237} , the total 93 content does not vary appreciably with time after shutdown.

Cunningham and Werner have tested the carrying power of bismuth phosphate for reduced element 93 at concentrations expected from a 100 kw pile operating for two months; in two experiments 27% of the 93 was carried. As it is possible that, in the Wet Fluoride Process, the plutonium-containing lanthanum fluoride precipitate will be put in solution by treatment with zirconium, Cunningham and Werner have tested plutonium fluoride with zirconium nitrate and find it soluble. Preliminary work has been done concerning a potentiometric titration of plutonium in order to determine the oxidation potential.

Brown, Hill and Bohlmann have performed additional distillation studies on neutron-bombarded UF_6 and find that, in agreement with previous studies, only about 5% of the 94 is volatilized with the uranium. The anhydrous reactions of bismuth phosphate have been investigated; and it is found that it can be volatilized in a stream of fluorine at $600^{\circ}C$, suggesting a possible means for removing 94 from large precipitates quite readily, provided a method for separating the plutonium and bismuth fluorides can be devised. Davidson, Koshland and Thompson have studied the oxidation reactions of 94: Davidson finds that 94 can be oxidized only partially by dichromate in the presence of HF. Koshland finds that the presence of zirconium in the HF solution aids in this oxidation; he also finds that with nitric acid concentrations above 3 N the oxidation of 94 is appreciably slowed down, supplementing earlier work by Gofman in Berkeley. Thompson finds that, with the use of $AgNO_3 - K_2S_2O_8$, 94 may be

3/2/43

oxidized even in 10 N HNO_3 , confirming results by Hamaker in Berkeley. Kohman and Koshland have worked on the zirconium method for dissolving fluoride precipitates with the following results: (1) Relatively low concentrations of zirconium and high acidity are necessary to prevent zirconium itself from precipitating; (2) lanthanum fluoride precipitates can be dissolved by a solution containing an equal weight of zirconium, but twice this amount is recommended; (3) it is necessary to heat to 98°C for one hour in order to oxidize the plutonium in the resulting solution with dichromate. Peroxysulfate oxidation catalyzed by silver is much more satisfactory since the oxidation goes rapidly at room temperature. Thompson has conducted preliminary tests of the effect of proposed uranium coating metals on the recovery of 94 in the Wet Fluoride Process; indications are that probably less than 10% loss of 94 will result from the presence of any of the metals or their ions.

Covey showed me a colored photograph (see Figure 29) of the New Chemistry Building that he took on Washington's Birthday, a nice, clear day.

I received a wire from Pan Jenkins in Berkeley, saying that at Eastman's suggestion he has consulted Louis Strait about possible employment with me as a spectroscopist, but it would be difficult for Strait to leave now. Jenkins suggested that I contact Mulliken and people at Michigan for other possibilities.

Willard and I, along with Franck, Cooper, Miles, Boyd, Adamson, Smith and Sutton, attended a conference on adsorption in Franck's office at 9:00 a.m. The conference was called by Cooper to plan a program for investigating the possibility of a separations process based on adsorption techniques. Decisions reached were: (1) Willard's group will concentrate next week on column work with silica gel as the adsorbent. (2) Sutton's Separations Process Section will attempt to set up preliminary equipment for a semiworks scale separation process within a week. (3) Willard will conduct exploratory tests on new adsorbents for adsorptive and desorptive characteristics using test tube equilibrium experiments; those showing promise from these high-spot tests are then to be tested in small adsorption columns. (4) Boyd's group will conduct the intermediate-size

3/2/43

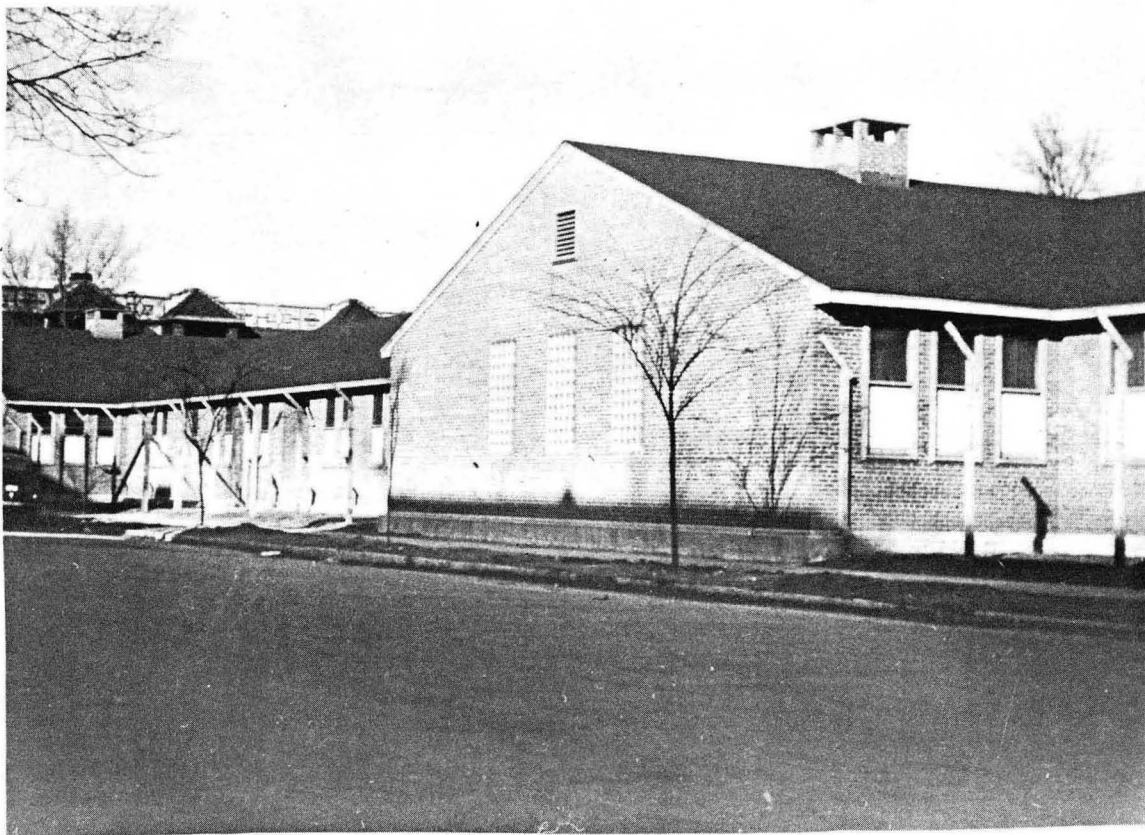

Fig. 29 New Chemistry Building, February 22, 1943. Facing northeast from Ingleside Avenue. (XBB 768-7454)

3/2/43

column work. (5) The objective of the above work will be to gain enough information to proceed with design in about a month, it being agreed that intense cooperative effort will be expended. (6) The next conference on adsorption is to be held in Franck's office a week from today at 9:00 a.m., March 9.

I wrote a memorandum to Allison suggesting that we postpone a decision on obtaining large amounts of "light oxygen" and "light carbon" for about three months, in which I gave the following reasons: "1. The Oppenheimer Group should have determined the yield of the α, n reaction on O^{18} and C^{13} , using samples of 'heavy oxygen' and 'heavy carbon.' I am sure that Professor Randall will be glad to furnish samples of 'heavy oxygen' for this purpose, and that samples of 'heavy carbon' could be obtained from Nier at Minnesota. 2. At the present time the main reason for even contemplating the need for 'light oxygen' and 'light carbon' is for their use in refractory material. This necessity has been deduced from analogy to uranium casting, and therefore a search is being made in the Chemistry of 94 Section for refractories which are satisfactory for casting uranium and which do not contain oxygen or carbon. 3. It should be possible to soon prepare microscopic amounts of plutonium metal and to study the properties of the final product. The possibility exists that the study of plutonium metal itself will change our whole outlook on the problem. This work is going on in the Chemistry of 94 Section."

Professor Arthur J. Dempster of the University of Chicago Physics Department has agreed to take over as director of patent affairs for the Met Lab. As a consultant, Dempster has been in constant contact with the development of the work here and has served as a patent expert for the firm of which York and Wells are members.

Nick Dallas increased from one-half to three-quarter time work today; he is still working with Magel on the plutonium metal production problem.

I held our regular Section meeting of Research Associates in my office in the evening. English described the status of our radiation detection instrumentation (alpha particle counters, FP-54 ionization electroscopes

3/2/43

and Geiger-Müller counters), Willard summarized his work on the Adsorption Process and Thompson his work on the Bismuth Phosphate Process.

After the meeting Helen and I had coffee and cake at the Ghiorso's to celebrate Helen's birthday which is today.

Wednesday, March 3, 1943

Robert L. Patton, the insect physiology instructor at Cornell who did graduate work under Craig, wrote me a letter indicating that most of the obstacles in the way of his coming to Chicago as a microchemist have been removed. He asks for the earliest and latest starting dates that I would consider.

I sent a letter to Gofman, which is self-explanatory. "Dear Jack," I said, "I am sorry that such a failure was made in trying to melt the metal from its hard-soldered mooring to the backing plate. The material became so oxidized during this procedure that it is certain that it would no longer have been of any use to you for your experiment. It was thought that a quick heating would work. A contributing complication, of course, was the fact that the target was so 'hot' that no one here was very anxious to work with it, and this undoubtedly led to some carelessness in its handling.

"We are airmailing to you today about 100 grams of neutron-bombarded uranium metal. This received 175,000 μ ahr at St. Louis over a 9-week interval, and the end of the bombardment was about 6 weeks ago. In addition, we are mailing to Professor Eastman about 200 to 300 grams of this material. It is our guess that this material has a specific activity of about 1 count/min/mg, and we will determine this roughly and send you the figure. In one small way, perhaps not too unimportant, this material is superior to the deuteron-bombarded material; namely, the activity is distributed uniformly throughout, and you can be sure that it is all in a good metallic form and not oxidized.

3/3/43

"I don't know exactly what experiment you have in mind to do with such material, but if it can not be done with the low specific activity material which we are sending to you, there is perhaps still a way out. As you probably remember from Magel's work, Report CN-363, the 94 concentrates in the distillate by a factor of about 100 when the 94-containing uranium metal is distilled. Perhaps Professor Eastman can concentrate some material for you by such a method. In any case, I have asked Magel to try to do so for you, and he has said that he will be glad to and will start to do so as soon as possible. He will distill it onto tantalum foil and if successful will send this foil to you. It probably will not be in very neat compact form on the tantalum foil, but since you will be sure that it is in the metallic form this perhaps does not matter too much.

"I raised the question of whether Hamaker and Sheline might pay us a visit in Chicago largely from the point of view of wanting to make it known to them, that the microchemistry group here would be glad to have them come to see what is going on and to exchange ideas with them. I want them to feel that they would be very welcome to come if this should seem to be the efficient thing to do; if it would not benefit their work in the long run, but rather only interfere with it, then naturally I do not think that they should come."

Following up my letter, Magel airmailed to Gofman about 100 grams of neutron-bombarded uranium metal. He also sent a few hundred grams by ordinary mail to Eastman in Berkeley.

I received a copy of a memo that Sutton sent to Cooper requesting that 50 pounds of UNH from the last St. Louis bombardment (Chicago III) be reserved for use in his semiworks adsorption columns this month. He states that Smith has agreed that this will still leave sufficient material for the checking of the modified Wet Fluoride Process in his (Smith's) other semiworks. Since it is planned to test an Adsorption Process that has already been pretty well worked out insofar as recovery of the product is concerned, Sutton does not expect to lose an appreciable amount of 94 in this work. He concludes by saying that the product 94 can be turned over to our chemistry group along with the product 94 from the

3/3/43

Smith semiworks run for the use originally planned, i.e., as a source of $^{94}_{239}\text{Pu}$ for the microchemists.

Allison wrote Latimer today saying that it has been decided not to purchase the large amount of partially separated oxygen isotopes from Professor Randall's supply; he requested a small sample (25 cc of water) to be used for tests.

Helen worked at the Metro Y today. Tonight as a birthday celebration I took her to Pete's Steak House on Dearborn near Randolph, followed by a movie, at the RKO Palace Theater in the Loop, called "Hitler's Children," featuring Tim Holt, Bonita Granville, Kent Smith, Otto Kruger and H. B. Warner. Afterward we again had coffee and cake (left over from last night's party) with the Ghiorso's.

Today the newspapers tell us that the U.S. has smashed a Japanese convoy headed for New Guinea. Four Japanese ships were sunk or damaged, and thirteen planes were shot down.

A Laboratory Council Policy Meeting was held at 10:00 a.m., attended by Allison, Cole, Compton, Cooper, Doan, Fermi, Franck, Hilberry, Miles, and Spedding. Doan announced that a directive has been received from Stewart of OSRD requiring the working hours of the secretaries on the Project to be increased from 40 to 48 hours per week. Compton told the Council that this policy will be put into effect immediately. Compton cited Groves' belief that the Project must, for military reasons, continue beyond the war; hence the U.S. Government will be responsible for keeping a research laboratory alive for a long time to come. Compton said the Army objects to building new buildings at the University of Chicago but is willing to build at Argonne; perhaps this attitude is due to political considerations. He stated that the immediate job is to get information for plant designs and to train men. The first high-level pile will start about July 1. When it was mentioned that heavy water will be coming in about then and Franck asked about plans for a heavy-water pile, Compton indicated that the main effort will be directed to a

3/3/43

water-cooled graphite pile, with a heavy-water pile to be developed as a line of reserve. The Army's desire to move the Berkeley group to Chicago was brought up; Compton was of the opinion that the older men would probably drop out of the Project and more might be lost than gained by such a move. With regard to the light element impurity problem, Compton obtained the agreement of the Council that no request be made at this time for the preparation of O^{16} for refractories.

Thursday, March 4, 1943

Brown, Hill and Bohlmann have devised a means for effecting fluorination reactions under pressure. Today a small sample of UF_4 was placed in a copper boat, and this was placed in a reaction vessel which was evacuated and then connected to the tank of fluorine. Fluorine was admitted at 20 pounds above atmospheric pressure and the temperature was brought to about $500^{\circ}C$. After a few minutes a small trap at one end of the reaction vessel was cooled with liquid nitrogen, thus condensing most of the fluorine in the system together with the UF_6 . The fluorine in the trap was then allowed to boil off as dry ice was placed around the trap. The weight of the UF_6 remaining in the trap was then determined by weighing, and it was found that a yield of UF_6 of essentially 100% was produced. This procedure has general applicability to the production of fluorine compounds.

I sent a letter to Eastman in Berkeley explaining our decision to study the need for O^{16} before requesting production. I told him of the irradiated uranium sent to him and to Gofman. With regard to his forthcoming visit the week of March 22 I wrote: "The meeting of the Laboratory Council, which I referred to in our telephone conversation, is set for 10 a.m. on March 22. In order to make this meeting it wouldn't be safe to plan to arrive on one of the trains which are due on this morning, since these trains are invariably late nowadays. I have asked Mr. Doan to arrange for you and Kirk and Magel to visit the Westinghouse Company in Bloomfield, New Jersey, on March 24, and the Metal Hydrides Company at

3/4/43

Beverly, Massachusetts, and M.I.T. on March 25 and 26. I had hoped to go along with you, but I am not sure now whether I will be able to make it."

My other letter today went to Patton at Cornell University, expressing our pleasure that he may be able to come with us. As for starting dates, I suggested one or two weeks from now as the earliest practical date from the standpoint of processing negotiations through our personnel office; the latest date would be any time this year.

Helen went shopping with Wilma Ghiorso today.

Coryell spoke at the Laboratory Research Associates meeting this evening in Rosenwald Auditorium, giving a complete summary of the fission product work in his Section; he presented an impressive picture of progress made in the last couple of months. At the Chemistry Research Assistants seminar held in my office, English described counting circuits and their operation and Kohman gave a summary of the fission product yields.

Today's headlines report a Japanese naval disaster. The U.S. destroyed all the ships in the Japanese convoy headed for New Guinea; there were ten warships and twelve transports. Fifty-five planes were shot down.

Friday, March 5, 1943

Benjamin F. Scott, Jr., a University of Chicago graduate student, started to work as a Research Assistant in Section C-I today. I plan to have him work with the instruments group in Room 7 in view of his experience in electronics.

Coryell circulated a memorandum entitled, "Fission chains, yields, decay relationships, β and γ energies, and mass assignments." Attached are four tables which he says give as complete a picture as is possible at this date of the radiochemistry of the ordinary fission products produced

3/5/43

by cyclotron slow neutron irradiations. This is the information he used as the basis of his talk at the Research Associates meeting last night.

I received a phone call from H. S. Wade of Owens-Illinois Pacific Coast Company in San Francisco concerning our interest in having Clifford Smith of his company join the Met Lab on a leave-of-absence basis. Wade indicated it will be possible if Smith wishes it.

To give an idea of some of the problems the Met Lab will be working on during the next few months, I reproduce a memorandum that has just been issued by Compton's office, called "Tentative assignment of problems concerning W Plant."

"Reference is made to the letter of C. H. Greenewalt to A. H. Compton of February 27, 1943, in which the Metallurgical Laboratory is asked to investigate certain questions connected with design problems at W.

Problems assigned to Cooper

- 1(b). Adequacy of shield construction
8. Stability of metal in water (Howe)
11. Compilation of properties of graphite (Lane)
12. Corrosion and erosion of aluminum rods
(Leverett, etc.)

Problems assigned to Christy

- 1(b). Adequacy of shield construction
- 1(c). Shielding for tube holes
- 1(d). Advisability of lead shielding

Problems assigned to Franck

- 1(d). Generation of hydrogen peroxide in radiation shield
4. Generation of hydrogen peroxide in water passing
through the pile
8. Corrosion of metal in water (with Howe)
12. Rapidity of corrosion of aluminum tubes

Problems assigned to Fermi

- 1(a). Heat generated in radiation shield
- 1(b). Radiation shields adjacent to ends--recommendations
2. Larger coefficients of metals used
5. Radioactivity induced in oxygen

3/5/43

7. Relative merits of CO_2 and He
9. Heat generation in graphite

Problems 3 and 6 proposed in Greenewalt's letter are being taken care of by sending Young and Weinberg to Wilmington for direct consultation with the du Pont engineers."

This evening Helen and I went to the Tower Theater to see "You Were Never Lovelier," starring Fred Astaire.

From the Russian front comes the good news that the Soviets have freed 102 towns on their drive to regain Smolensk.

Saturday, March 6, 1943

During the last week Perlman has taken some old residues from the working up of St. Louis neutron bombardments which has been done by Cefola and isolated about 200 micrograms of 94^{239} . He carried this through three additional oxidation-reduction cycles, ending with the 94^{239} mixed with about 700 micrograms of lanthanum in one cm^3 of solution. This solution was made alkaline with ammonium hydroxide, and the resulting precipitate was dissolved in 200 microliters of 0.7 M HNO_3 . Perlman has become expert in microchemistry as a result of a good deal of practice in recent weeks. The purpose of the present experiments is to test whether 94 can be purified by precipitating the peroxide in pure form from acid solution. He added about 50 microliters of 30% H_2O_2 , bringing down the precipitate of plutonium peroxide. This was dissolved in 100 microliters of 1 M HNO_3 and an insoluble black residue centrifuged out. The peroxide was again precipitated and then dissolved in 85 microliters of 1 M HNO_3 solution. This will serve as a stock solution for further ultramicrochemical work on 94. In order to assay the purity of the 94, Perlman measured out a small portion of this solution and evaporated it to dryness on a microplatinum weighing boat which he had weighed previously. This was ignited at 800°C for 15 minutes and reweighed. He then dissolved this plutonium dioxide and took an aliquot portion in order to determine the intensity of its alpha radioactivity. Using 47% as the geometrical efficiency of our

3/6/43

"inside" alpha counting chamber, he calculates that the specific activity of his 94^{239} is 1.53×10^5 alpha disintegrations per minute per microgram. This is in good agreement with the best determinations of the specific activity that have been made by Cunningham and Werner and indicates that this procedure of precipitation and reprecipitation of plutonium peroxide is an excellent one for purifying plutonium. In the course of this work he determined that the solubility of plutonous peroxide in 1 M HNO_3 is not more than about 50 mg per liter.

Stoughton prepared some granular zirconium phosphate for use as an adsorbent for 94 and he finds that this material in equilibrium-type tests shows better adsorption characteristics than silica gel.

I sent a letter to Pan Jenkins in Berkeley thanking him for the UBr_4 and the UCl_4 he sent us for some experiments we have in mind. I said that I heard that he has made some uranium hexachloride (UCl_6) and asked if he would have one of his men send us a short description of the method used in making it, and if possible, a small sample. Uranium iodide, I told him, would be of interest to us also in case he has done any experiments involving this material. The letter concluded with my regret that Strait, who has the ideal qualifications for the spectrochemical analysis job here, will be unable to come.

General Groves is in Chicago today.

Segrè wrote to me regarding the patent write-up for our invention (with Kennedy) concerning the use of 94^{239} as the fuel for a pile. He said that Lt. Baird had brought him the patent write-up and that he will give it his closest attention as soon as possible.

Just as I was leaving for the day I received a telegram from Roderick Craig in Berkeley saying he will arrive in Chicago on the Overland, Ltd., at 8:30 a.m. next Tuesday.

Helen and I had the Foster Yorks to dinner.

Sunday, March 7, 1943

Tuesday is Stan Thompson's birthday, so Helen and I had Stan and Alice come to our apartment for a little celebration.

Monday, March 8, 1943

Today we are starting to recover 94^{239} , for use by our microchemists, from the semiworks source. Cefola is undertaking to work up the lanthanum fluoride precipitate and will also work up the bismuth phosphate precipitates, produced in W. Q. Smith's Chemical Engineering Section as a result of semiworks operations on neutron-bombarded UNH available from the third large St. Louis bombardment (Chicago III, which terminated on January 23). He will isolate the 94^{239} through the use of a number of oxidation-reduction cycles with lanthanum fluoride carrier.

Hamilton sent a wire from Berkeley saying that 300 microcuries of iodine-131 are being sent to us by air. This radioactive iodine will be used to study the possible extent of evolution of 8-day iodine during the metal-solution step in the 94 separations process.

This was followed by a letter from Hamilton describing the difficult situation due to the many demands on the cyclotron by Oppenheimer, Cole and John Lawrence, in addition to the needs of Wahl and me. He is sympathetic to my needs and wants me to know how matters stand so I won't be disappointed by future delays. He had a long talk with Alvin Graves and sent him home to Chicago with an ample supply of ionium; Graves hopes to extract more ionium from residues at the Mallinckrodt plant in St. Louis. He also informed me that Prestwood is coming along nicely with the polonium separation and may have as much as six or seven hundred millicuries out of the solutions within the next few weeks.

I made the following entry in my notebook today and had it witnessed by Cunningham and Perlman: "If there is an appreciable amount of 93^{237} produced in any of the uranium chain reacting structures, this isotope

3/8/43

might be useful for fast neutron chain devices. Although the one test which has been made on its fissionability indicates that it does not undergo fission with slow neutrons, it is possible that its fission threshold is only slightly above the region of thermal energy. With a low fission energy threshold, suitable fission cross sections and secondary fission neutrons, and low cross section for the n, γ reaction, the isotope 93^{237} might compare favorably with the other three isotopes (94^{239} , U^{235} and U^{233}). Further tests on the fissionability of 93^{237} should be made in order to establish the fission energy threshold, cross section, etc. It is especially important to check again the possibility of its fission with slow neutrons, since with this property it might be useful in slow neutron as well as fast neutron devices. It might also be advantageous to mix 93^{237} with 94^{239} , U^{235} and/or U^{233} in either fast or slow neutron devices.

Helen worked at the West Side Y in the morning and later went to the Girl Reserve meeting.

At the Chemistry Division meeting tonight the time was given over to the Health Division with a talk by S. T. Cantril, Chief of the Section on Clinical and Medical Research. Waldo Cohn, who has just returned from a visit to Berkeley, also gave a talk.

Today's headlines feature the African front as Rommel prepares for his third assault on the British 8th Army, having been repulsed on his first two attacks.

Tuesday, March 9, 1943

Bernard A. Fries started work as a Research Associate in Section C-I today, coming from the University of California where he has been a research neurophysiologist in the medical school in San Francisco (salary \$290 per month). I have known him since undergraduate days at UCLA. He will work on extraction processes for 94, starting with Willard in Room 11 on our present high priority work of investigating the adsorption process.

3/9/43

Roderick Craig arrived this morning as scheduled and conferred with Kirk on the operation of their microbalance.

Our second conference on adsorption was held in Franck's office at 9:00 a.m. Besides myself, others present were Franck, Cooper, Sutton, Boyd, Adamson and Willard. Sutton discussed the program in detail, listing eight or nine topics under both engineering and laboratory work. Some of these topics were: rate of flow versus head and depth of bed, actual construction, the semiworks set-up, treatment of adsorbent, removal of suspensions, percent of adsorption and desorption versus rate of flow and in successive cycles, new adsorbents, effects of radiation in presence of reactants, capacity, and effects of coating materials and impurities. It has developed, he said, that the IR resin from the manufacturer has to be screened and treated with water for some time in order to prevent plugging of the bed. He foresees that the suspended particles must be prevented from reaching the bed, and it will be necessary to use high purity water, filter all solutions, etc.

Willard was the next speaker. He showed two graphs, the first showing percent adsorbed versus time of shaking for various adsorbents and the second showing percent adsorption versus liters of solution/kg of adsorbent. He discussed the adsorption efficiency of silica gel (impregnated with various materials), powdered quartz, activated alumina and Hyflo Super Cel. At the conclusion of the meeting we talked about getting Robert Meyers of Resinous Products Company, Philadelphia, and H. K. Livingston of Wilmington as consultants. The next conference is scheduled for a week from today.

After considerable discussion between members of Latimer's group in Berkeley and Met Lab administration about their transferring here, Hilberry sent a memorandum to Major Peterson of the Manhattan District Chicago office that it appears impossible to transfer the California group to Chicago. He reported that the men who serve as supervisors of the group are the remnants of the active Chemistry Department faculty and are spending approximately halftime on the Project; if the Project were to be transferred to Chicago, they would have to drop out.

3/9/43

On Franck's recommendation, Compton directed Boyd to devote fulltime to the work of the combined groups on adsorption methods of separation. Potratz will now assume active direction of the Analytical Section temporarily until Boyd's task is finished.

Today Helen worked at the Metro Y.

We held our regular meeting of Section C-I Research Associates this evening, with our new addition, Bernie Fries, attending for the first time. We reviewed the status of our various research programs. Craig also attended our meeting and reported on his research program at Berkeley.

Wednesday, March 10, 1943

I received a letter from Rollefson in Berkeley reporting on his current spectrographic activities. Besides getting the apparatus into working order, he and Dodgen have been carrying out a series of experiments that should tell them the smallest quantities of various substances they can detect and what lines in their spectra will be the best to use. They are encountering difficulty with some elements, such as uranium and rhenium, because of their complex spectra. For this reason they have not yet tried Cunningham's plutonium sample. Rollefson is optimistic about setting up a grating spectrograph here, and he recommends a Paschen-type mounting which will permit taking the whole spectrum in as many orders as desired at one time. He assumes that it will be comparatively easy for us to acquire a grating, since the University of Chicago possesses one of the two or three ruling machines in the country. He said that this letter should serve the purpose of a report on this work. He said Dodgen might come to Chicago if we need him, and he himself could also join our Chicago group, but it might be better if they remained in Berkeley where they are better set up to do their work.

Beaton wrote from Waynesboro, Virginia, that he is sorry that we cannot use his services on a part-time basis and that he cannot get a

3/10/43

leave of absence at the present time. He promises to get in touch with me in the future if the possibility of coming here materializes.

I prepared "An Account of the Conception of the Adsorption Method for Isolating 94." This document was prepared at York's behest for possible patent purposes; and in it I fix the dates on which I conceived, or discussed with others, various adsorption methods, the earliest dates being in 1941. I also gave an account of my early experience in adsorption work dating back to 1938, when I discussed adsorption methods with Professor Zechmeister, a world authority on adsorption, and helped him set up his lecture-demonstration experiments in Berkeley for a talk on this subject. Also in August 1940 I published a review article (Chem. Rev., 27, 199 [1940]) in which I described experiments on adsorption that had been done in connection with artificial radioactive isotopes. Perlman prepared a supporting document, fixing the dates of conversations he and I had on this subject, namely, the middle of March 1942 while we were still in Berkeley, and during the period of April 17th to 19th, 1942, while we were on the train trip to Chicago, after which we first started work here. He also pointed out that at the chemistry conference held at the Met Lab three days later I proposed several methods for the extraction of 94, one of them being the adsorption method.

A new girl, Virginia Crawley, started to work as a secretary in our office today to assist Edrey Smith with her increasing work load. She will have her desk in Room 14, along with those of Edrey and Annis Moore, making the room somewhat crowded.

According to the news today the Nazis have struck a big counter blow against the Russians and have recaptured eight cities on the Donetz Basin, south and southeast of Kharkov.

There was a Laboratory Council Policy Meeting at 10:00 a.m., attended by Allison, Cantril, Compton, Cooper, Doan, Fermi, Franck, Greenewalt, Hilberry, Miles, Peterson, Spedding, and Wollan. Compton reviewed the history of Site X. Oral agreement has been reached for the University to operate the facilities. Work to be carried out

3/10/43

at Site X will be designed to get information for Site W, and to carry out such other experiments as are decided upon by the Chicago Laboratory Council. There were discussions of a program for testing the cooling water at Site W, and the Met Lab Laboratory space problems—all of Eckhart and Ryerson will be taken over by the Project (except for the big lecture room on the first floor which will probably have a separate outside entrance for general University use). However, all of Jones and Kent Laboratories must be vacated by Project people, some of whom can move to the West Stands, which will become available in its entirety on July 1.

The Laboratory Council met again this afternoon; present were Allison, Compton, Cooper, Fermi, Franck, Greenwalt, Hilberry, and Peterson. Greenwalt announced that the water-cooled pile, which was decided upon last month for the Site W production units, will have a uniform lattice spacing throughout of $8\text{-}\frac{3}{8}$ inches x $8\text{-}\frac{3}{8}$ inches. There was a discussion of neutron-gamma shielding for the pile. Greenwalt stated that du Pont does not like the Wet Fluoride Process for Site W. He proposed to abandon, at least temporarily, equipment design on the Wet Fluoride Process and asked us at the Met Lab to evaluate as rapidly as possible the adsorption processes; Franck indicated such work is already in progress.

Thursday, March 11, 1943

Eastman wrote from Berkeley thanking me for sending him the sample of neutron-bombarded uranium metal March 3. He mentioned his particular interest in electrolytic processes and refractories in connection with his trip East to visit metallurgical facilities and asked to include Princeton in his itinerary, as there is a group there working on refractories. He indicated he would be leaving Berkeley either on the Streamliner on the 17th or on the Overland on the 18th, either of which will give him some extra time in Chicago and asked me to recommend a convenient hotel. He also indicated that he has not sent the requested sample of Randall's water pending further information on its value and further instructions from Allison.

3/11/43

Gofman sent a telegram from Berkeley asking for another shipment of silver (93^{239}) if available. In response, we shipped him one millicurie of the purified isotope 93^{239} and notified him of this by wire.

Helen and I had Roderick Craig for dinner. After dinner, Craig and I walked back to the New Chemistry Building, where our chemistry Research Assistants seminar was in progress. Here, Brown described the operation of chain-reacting piles to produce 94^{239} , 93^{237} , and so forth. Turk described his adsorption experiments. La Chapelle described his work on adsorption. Knox talked about wet extraction methods. Miller described the Bismuth Phosphate Process, and Werner covered the microchemical work on the determination of the oxidation states of plutonium. The meeting was over at 9:20.

Friday, March 12, 1943

Davidson and Miller, working with Thompson, have succeeded in demonstrating a complete oxidation-reduction cycle in the Bismuth Phosphate Process. The initial bismuth phosphate precipitate incorporating the 94 was dissolved in 10 N HNO_3 , then the 94 was oxidized with $\text{S}_2\text{O}_8^{--} + \text{Ag}^+$. The solution was then diluted and bismuth phosphate precipitated by the addition of H_3PO_4 . The bismuth phosphate was separated by centrifugation and then the 94 in the effluent solution was reduced with SO_2 by allowing the solution containing SO_2 to stand overnight. Thompson's experiment on February 27 in which the reduction with SO_2 lasted for only a half-hour led to poor yields. The reduced 94 was then co-precipitated with bismuth phosphate by adding Bi^{+3} to the solution containing H_3PO_4 . A yield of 96% of the 94 was achieved.

Cunningham and Werner completed today the determination of the composition of another plutonous compound. Plutonous oxalate was chosen for this purpose since microgram quantities of oxalate may be accurately determined by oxidation with ceric ion. To about 11 micrograms of plutonium in six microliters of 1 N HNO_3 was added approximately 0.1 microliter of 0.1 M potassium oxalate. In one-half hour the plutonium oxalate had

3/12/43

deposited in the form of yellow prismatic needles. The crystals were allowed to stand in contact with the mother liquor overnight. A change in crystalline form occurred, the oxalate now appearing as a cluster of yellowish green rosettes. The precipitated oxalate was washed six times with 1/2 microliter portions of 0.25 N HCl. Ten microliters of 6 N H₂SO₄ were added and the mixture warmed and stirred until all of the oxalate dissolved. Fifteen microliters of 0.0167 N Ce⁺⁴ were added to the solution. Five minutes were allowed for the reaction to go to completion. The excess ceric ion was then determined by back titration with standard ferrous solution, using the ferrous-phenanthroline complex as indicator. Plutonium in the solution was determined by alpha count. The mole ratio of oxalate to plutonium was calculated as 2.17:1. The fact that the ratio was higher than the anticipated 2:1 is believed to be due to co-precipitation of potassium oxalate. Such co-precipitation is known to occur in the precipitation of calcium oxalate.

Greenewalt has been making inquiries in the Chemistry and Technical Divisions about transferring some du Pont research men to the various Sections as Research Associates. I told him I would be delighted to have eight men, mentioning in particular Donald Lee now in the Ammonia Department (and a fellow graduate student in Chemistry at Berkeley in the 1930s), R. H. Beaton in the Acetate Division of the Rayon Department and Vance Cooper who is in the Explosives Department. Charles Cooper has asked for J. O. Maloney, who is now in the du Pont Engineering Department, and H. W. Bellas who is now at one of du Pont's explosives plants.

For some time I have felt that Cefola could use an assistant and recently it occurred to me that Rochford, Benedetti-Pichler's student at Queens College in Flushing, New York, might be the right man. In response to my letter, Benedetti-Pichler said that he talked to Rochford about my offer, who thinks it is a "splendid opportunity," but they concluded it would be best for him to wait until he gets his degree in June. He concluded his letter by saying that the College laboratories were closed for a few weeks during the cold weather for lack of coal. "Finally we got some money for equipment which, however, can no longer be obtained.

3/12/43

Microanalysts are wanted everywhere, but how can I train any under these conditions? Nevertheless, I keep on trying."

I wired Eastman in Berkeley, recommending the Shoreland Hotel during his stay in Chicago.

Helen and I had dinner at the Ghiorsos' together with Stan and Alice Thompson. After dinner Helen and I went to the Comptons' to view some of Greenewalt's stereopticon slides. Mrs. Greenewalt was also among the guests. Greenewalt is an expert at photographing hummingbirds on the wing, and we saw some beautiful examples of his work.

Saturday, March 13, 1943

Because of Greenewalt's and Compton's interest in the adsorption process for separating 94, we have been putting a great deal of effort on this method during the last couple of weeks. Helping Willard have been Turk, Stoughton, Orlemann, Fries and La Chapelle. They have investigated the adsorption of 94 on a number of different brands of silica gel varying between rather wide limits in density, purity, color, acid content and adsorption capacity. The lower density silica gels give the best adsorption of 94 from 10% UNH solution. They have measured the time required to attain adsorption equilibrium of 94 on silica gel and the time required to attain complete elution. They have also measured the effect of particle size of the silica gel and the effect of pH on adsorption of 94 by silica gel. They have measured the adsorption of the fission product gamma activity and find that the zirconium and columbium fission species are adsorbed to a large extent but are not eluted under conditions in which much of the 94 is eluted. They have also studied the use of such inorganic adsorbents as uranous fluoride, potassium-thorium fluoride. None of these show much promise with the possible exception of zirconium phosphate. They also tested the adsorption of 94 and fission product gamma activity on a series of substances supplied for testing by the du Pont Company. These do not appear to be particularly hopeful. They also

3/13/43

tested the carbonaceous zeolite "Zeo-Karb" marketed by the Permatit Company. This adsorbed both the 94 and gamma and beta emitting fission products, but the eluants that were tested do not seem to elute the 94 and fission products very well.

Cunningham and Werner have continued to try to isolate the 93^{237} from the second large St. Louis neutron bombardment (Chicago II) but have not succeeded in finding more than a small fraction of that thought to be produced in the bombardment. The reasons for this are not clear.

I received a letter from Leonard Dreher in Downey, California, saying that he has received a formal offer from Moulton's office to join our Section (at \$300 per month). He is inclined to accept the offer, whether he gets a leave of absence or not, and will give me a decision by wire next Monday evening. He wants to know if the moving allowance will permit him to bring a piano.

Jenkins wrote from Berkeley notifying me that 50 grams of uranium hexachloride were sent to us by air express on Wednesday. This material, he said, is even more hygroscopic than the tetrachloride and the easiest way to handle it is in a crock having dry ice at the bottom. He summarized the method of preparation, saying that it consists of a vacuum sublimation from the pentachloride. He told me that he no longer has any pure uranium tetraiodide and suggested that I communicate with C. J. Rodden at the Bureau of Standards if we need a considerable amount.

I received a letter from Patton at Cornell University. He has asked for a leave of absence from the University effective April 1 and expects to arrive in Chicago Sunday evening, March 28. He wishes to occupy a four-room furnished apartment here and so would appreciate our suggestions.

Frances Chilson, Helen's cousin, spent the night at our apartment.

Sunday, March 14, 1943

I held a 10:30 a.m. meeting in my office of my newly created Council of Section C-I consisting of group leaders and sub-group leaders; present were Perlman, Willard, Kirk, Cunningham, Brown, Orlemann and English, and Craig as a visitor. This is the first of the Sunday morning meetings, to be held at this time because all the evenings, Monday through Friday, are filled with meetings of some kind or other. (Included among the meetings that some of the Research Associates in my Section attend are: (1) Chemistry Division meeting on Monday night, (2) meeting of my Section on Tuesday night, (3) proposed meeting of my purification and metal production groups on Wednesday night, (4) Project-wide meeting on Thursday night, (5) Technical Division meeting Friday night.) A short discussion was held on the Bismuth Phosphate Process, and it was decided to attempt dissolving the bismuth phosphate in 4-5 M HNO_3 rather than 10 M HNO_3 using larger volumes, in order to facilitate subsequent oxidation of the 94. I discussed the situation with respect to new personnel, indicating we have decided to invite Flagg (a well-known radiochemist) even though his stay might be only for 2-1/2 months. A job has been offered to Rochford (Benedetti-Pichler's student), the du Pont Company is trying to obtain Beaton's release for us, Spector from Yale may come with us in June, and Craig will ascertain Jenny's (Professor of Soil Technology, Berkeley) availability when he returns to Berkeley. Some of the extraction work of the past week was reviewed:

Wet Fluoride Process. Knox finds that 2% H_2O_2 reduces 94 at room temperature, but there is a difficulty in that uranium peroxide comes down under these conditions; a possible remedy is to raise the HF concentration to 2 M. Koshland is attempting to put the control work of the Wet Fluoride Process on a firm footing.

Phosphate and Adsorption Processes. It was suggested that the Otto Hahn article finding that zirconium hypophosphate carries 93 incompletely should be checked on 94. It was also suggested that zirconium hypophosphate be checked as an adsorbent.

93^{237} problem. Cunningham reported that 93 follows along with 94 in the Wet Fluoride Process; hence, he should not have lost 93^{237} due to the chemistry of the isolation procedures. I speculated that the low yield of

3/14/43

93^{237} in the St. Louis bombardment as compared with that originally obtained in Berkeley could be because the material from the boxes closest to the target may not have been used for this work. Another possibility might lie in the fact that the Berkeley sample was not extracted for a year whereas the St. Louis material was processed soon after shutdown—perhaps the 7-day period consists of an isomeric transition to a lower state after which a further decay to 93^{237} could proceed with a half-life of about a year.

Purification program. A future program was outlined for micro-chemical work at Chicago and at Berkeley. The Chicago group will work on wet methods for purification, chemistry of 93 and isolation and separation methods for U^{233} . Both groups will work on particular aspects of analytical work, distillation methods, general metal production, extraction and decontamination and fundamental chemistry of plutonium. Our schedule for the use of the 160 micrograms of pure 94 on hand was listed: Craig—Berkeley, 30; Rollefson—Berkeley, 10; Kirk, 30; Cunningham, 30; Werner, 20; Orlemann, 30. In addition, 10 micrograms will be devoted to carrying experiments at high ratios of 94 to carrier.

Metal production. The use of lithium as a reducing agent and organic solvents were suggested in place of sodium and water.

Frances Chilson left our apartment at 1:30 this afternoon. Later, Craig took Helen and me to dinner at Pete's Steak House.

Monday, March 15, 1943

Alex Langsdorf wrote a letter from the Department of Physics in Washington University, St. Louis, about the difficult time he is having in getting apparatus together for the experiment I proposed that he do, namely, the determination of the absolute number of beta particle disintegrations in the decay of 93^{239} (which emits conversion electrons as well as beta particles) through measurements on the decay sequence $U^{239} \xrightarrow{\beta^-} 93^{239}$ (in which the 24-minute U^{239} emits only beta particles); this information is needed in order to determine the half-life of 94^{239} through measurements on the decay sequence $93^{239} \xrightarrow{\beta^-} 94^{239}$.

3/15/43

"All we had was a Lauritsen electroscope," he wrote, "which seemed pretty inadequate to get an absolute determination of the number of disintegrations per second on an unknown β -ray spectrum. So I decided I had to have a GM setup and proceeded to build it." He then recounted all the troubles he had with the circuit. "Having gone this far, I wanted to have an end-window tube like yours. In fairly short order I made four and they had good plateaus. Then the trouble began. They either went bad from leaking air, or losing their good plateau. I decided the only way to tackle those tubes was by means of mass production to get a few good ones in a batch...."

"I am now trying to find how best to handle the gelatinous peroxide precipitate. I am getting decay curves which show a 24-minute component of considerable strength compared to background. In a few days I hope to have some preliminary results. Then I want to come up to Chicago to talk over the next steps. I have felt pretty discouraged over the difficulties of working here alone. The lack of help makes every bit of construction so slow, the lack of equipment to start with necessitated so much construction.... Please let me know what you want done next."

I sent a letter to Louis Strait at the University of California Medical Center in Berkeley, urging that he come with us on a six months leave-of-absence basis as his experience in analytical spectroscopy is very badly needed here. I stressed the extreme importance of the work and its interesting nature and said I have asked his friend Dr. Fries to write him on the matter so he could have additional confirmation of the importance of the work. I cautioned him not to mention the matters I discussed in the letter.

Today we sent Rollefson at Berkeley, for use in his program of spectroscopic determination of emission lines, about 10 micrograms of the 94^{239} isolated by Perlman earlier this month.

I wrote John Flagg expressing disappointment that he finds it impossible to join my group on a long-term leave-of-absence basis.

3/15/43

Helen went to the West Side Y in the morning and attended the Girl Reserve meeting at 63rd Street in the afternoon.

Burton was in charge of the Chemistry Division seminar tonight and featured was a talk by Shapiro on the mechanism of the decomposition of water by radiation. After the meeting Stan Thompson accompanied me back to our apartment where Helen fixed coffee for us.

Bad news comes from Europe: the Nazis claim to have recaptured Kharkov.

There was a Laboratory Council Policy Meeting, attended by Allison, Cantril, Compton, Cooper, Fermi, Franck, Hilberry and Spedding. Compton announced that the Army has issued a letter of intent to the University of Chicago for operation of facilities at Site X. He mentioned the need to overstaff in preparation for sending personnel to Sites Y, X and W. Fermi reported on a meeting he attended in Urey's office at Columbia University March 9. The meeting was called to discuss the possibility of building a homogeneous pile with heavy water. Although Halban was invited, the British intervened and would not let him attend. According to calculations made by Fermi and Urey, much more heavy water would be required to reach criticality than the three or four tons Halban has concluded would be necessary from some of his earlier experiments. Fermi said that he believes the Canadians will repeat Halban's experiments; he doubts, however, that they will have enough heavy water before August for a worthwhile experiment. Maybe by October they will have three to four tons. In the meantime, the Met Lab should have tanks, pumps, etc., set up in order to use heavy water when it becomes available to us. Also exponential experiments should be performed with homogeneous mixtures.

The desire of du Pont to have the adsorption method of separation pressed was mentioned; Cooper pointed out that the Wet Fluoride Process is still as feasible as ever. Policy matters raised in a memorandum from Mulliken were discussed, and it was concluded that

3/15/43

Section Chiefs should be made aware of all fast neutron research bearing closely on their fields, and possibly Research Assistants should be admitted to some of the Thursday evening meetings, e.g., every other meeting.

Tuesday, March 16, 1943

Leonard Dreher sent a wire last night as promised, which was delivered this morning, stating that he will join me at the Met Lab about April 1.

I attended a conference on adsorption methods in Franck's office at 9:00 a.m., along with Adamson, Boyd, Cooper, Franck, Smith, Sutton and Willard. Willard, Adamson and Sutton reported on progress of their adsorption studies. Among the decisions reached were that Adamson and Willard will set up standard batch testing procedures so that future tests by different groups will be comparable. The next meeting on adsorption is scheduled for next Tuesday at 2:00 p.m. in Franck's office.

Lom Squires of du Pont and I met in my office and discussed purity specifications that might be placed on the 94^{239} product to be delivered by du Pont from Site W. Assuming the product will be delivered in the form of some 94^{239} compound (as yet not determined), which is largely free of by-product radioactivity and of carrier material and impurities that might be introduced during extraction and decontamination procedures, I made the following recommendations as to purity: (1) the beta and gamma radioactivity should be a factor of 10^7 below that existing 60 days after shutdown following 100 days operation of a pile, (2) the compound should be at least 99% pure, (3) the amount of lithium, beryllium and boron present in the compound should each be as low as 0.01% or less.

Compton sent a memo to Division Directors and Section Chiefs today saying that in connection with the transfer of the Metallurgical Project from the OSRD to the Army it will be necessary to have an inventory of all Project property as of April 1, 1943.

3/16/43

Helen worked at the Metro Y today.

We held our regular meeting of the Section C-I Research Associates in my office in the evening. After the meeting Cunningham and Clifford Smith, who arrived today for his visit, dropped in to our apartment for coffee.

Wednesday, March 17, 1943

Clifford Smith of Owens-Illinois Pacific Coast Company visited the Met Lab and discussed with Kirk and me the possibility of joining Section C-I.

John Wheeler, who has been assigned to work with the du Pont people in Wilmington, sent me a wire from there that Greenewalt asked him to check our February 17 memorandum to Cooper concerning the gamma radiation hazard from 93^{239} made in a pile. According to Wheeler's calculations, the roentgens per day should be only one-tenth of what we reported, and this new figure he asked us to confirm.

Wheeler wrote me a letter, which I also received today. He plans to be in Chicago tomorrow and Friday and asked if he could see me between 9:15 and 9:50 Friday morning to ask a number of questions about the following subjects: spontaneous fission of 93^{239} , dosage due to 93^{239} and the energy level scheme of 94^{239} .

I sent a memo to Compton, with a copy to Greenewalt, summarizing my discussion yesterday with Squires regarding the purity specifications that might be required for the 94^{239} product from the Site W laboratory, indicating that I had recommended that the beta and gamma activity should be reduced by a factor of at least 10^7 below that existing sixty days after shutdown following a one-hundred day operation of the pile.

Adele Brown visited Helen this afternoon.

3/17/43

The Thompson baby, Ruth Ann, was born today at the University of Chicago Billings Hospital.

Thursday, March 18, 1943

"Report for Month Ending March 15, 1943, Special Chemistry of 94" with the report number CN and CF-514 is being issued. In this report I review the possibility of forming 94^{238} , 94^{240} , 93^{237} , 95^{240} and other isotopes in a high power chain-reacting pile. It is possible there would be about 5% as much 93^{237} as 94^{239} produced; if so, this isotope might be useful for a fast neutron device; and further tests on its fissionability, therefore, should be made. If the isotope 93^{237} does not undergo fission with slow neutrons but has a high cross-section for the capture of neutrons leading to the formation of 94^{238} , there could be a sufficient amount of this 50-year alpha activity mixed with the 94^{239} to complicate the purification problem. The possibility of an appreciable yield from the n,gamma reaction on 94^{239} seems rather remote; however, a cross-section one percent of the fission cross-section would result in enough 94^{240} to complicate the purity problem if it is a short-lived alpha emitter; if it is a beta emitter, this would give rise to 95^{240} which it might be necessary to separate from the plutonium final product. If the spontaneous fission rate of 94^{240} is high, e.g., a half-life of less than 10^{10} years, it might be serious. Another possibility is an appreciable n,gamma reaction with 93^{239} which could lead to the formation of 94^{240} by beta emission.

Kirk and Rosenfels report on techniques for the reduction of microgram quantities of uranium to metal, as a stand-in for 94, and conclude that as little as 10 micrograms of uranium can be successfully reduced, on the basis of their experiments on the reduction of uranium tetrafluoride with sodium. Brown, Hill and Bohlmann describe their work, using uranium as a stand-in, on a scheme for separation of boron from plutonium oxide by alternate treatments with HF-H₂ and H₂O-O₂ in a dry reactor. Perlman reports on his experiments using 200 micrograms of 94^{239} , recovered from several liters of residues, to confirm the use of

3/18/43

plutonium peroxide precipitations as a means of purification from lanthanum and other salts. After two peroxide precipitations a specific activity determination agrees within experimental error with the best average value previously determined. The solubility of plutonium peroxide in 1 M HNO_3 was determined roughly to be not more than 50 mg per liter, a quite tolerable figure.

"Report for Month Ending March 15, 1943, Chemistry of 94," with the report number CN-522, is also being issued. In this report Kohman calculates the amounts by weight of fission products to be expected at various times after pile shutdown in order to anticipate the effects on the recovery of 94. He finds that a number of the elements (strontium, yttrium, molybdenum and ruthenium) may be present in concentrations of several milligrams per liter in the initial uranium solution.

Brown, Hill and Bohlmann report their work on the volatility methods for separating 94, in which they have developed a new static technique using fluorine in a closed system under pressure. The volatilization of BiF_5 from BiF_3 treated with fluorine has been studied; and it is concluded that element 94 should be fairly easy to separate from bismuth in the Bismuth Phosphate Process, either by making use of the difference in their initial volatilization temperatures in fluorine, or the difference in their condensation temperature after volatilization.

Thompson, Davidson and Miller describe their continued work on the Bismuth Phosphate Process for separating 94, including methods of decontamination and volume reduction in treating the first step bismuth phosphate precipitate. Two tracer experiments have been completed of an oxidation-reduction cycle involving dissolution of the initial bismuth phosphate precipitate in 10 N HNO_3 , oxidizing with Ag^+ and $\text{S}_2\text{O}_8^{2-}$, diluting to 1 N in acidity and precipitating bismuth phosphate as a by-product, reducing the solution with SO_2 and again precipitating bismuth phosphate (and 94) by adding Bi^{+3} . Of the two experiments conducted, one gave good recovery of 94. Also studied was a combination of Bismuth Phosphate and Acetate Processes, whereby, after the by-product bismuth phosphate precipitation, the higher oxidation state of 94 is carried down with sodium uranyl acetate. La Chapelle, Fries, Orlemann, Stoughton, Turk and Willard have studied problems in connection with the large-scale use

of adsorption methods for separating 94. Equilibrium-type tests on the adsorption of 94 by silica gel lead to the conclusions that it is an effective adsorbent for 94, that the efficiency falls off with decreasing acidity, and that adsorbed 94 can be quantitatively eluted by HNO_3 . Tests of the adsorption on other substances show zirconium phosphate of a particular granular structure to be particularly promising. In addition, some commercial materials supplied by the du Pont Company show high adsorption of fission products combined with low adsorption of 94.

Also in Report CN-522, the University of California Group (Hamaker and Sheline) describes ultramicrochemical investigations on 94 which show that in the acetate method uranium can be precipitated as sodium uranyl acetate in the presence of reduced plutonium at Pu:U ratios as high as 1:100, leaving most of the plutonium in solution. A complete first cycle of the acetate method has also been run with the Pu:U ratio similar to that anticipated in the pile with a yield of plutonium of 92%. Connick, Duffield, Garner and Gofman report on two additional runs with the acetate method. Inactive carriers for nearly all the expected fission products were added to achieve concentration conditions expected with material from a 10^6 kw pile. The factor of increased concentration of 10^5 of fission products resulted in essentially no change in degree of decontamination. In one run hydroxylamine acetate was used in place of hydroxylamine chloride as the reducing agent with about the same results. An overall decontamination factor of 250,000 was accomplished in two cycles in the case of the hydroxylamine chloride run. Two cycles of hydroxylamine acetate run gave a factor of 100,000. Connick, Prestwood and Wahl describe the preparation of their "Fission Product Carrier Solution," Duffield and Gofman have a section on "Oxidation of Np and Pu and application to Np-Pu Separation," and Stein a section on "Analysis for Pu by the Lanthanum Fluoride Method on Semi-Micro Scale; Effect of Time of Centrifugation." Also included are reports by Burton's section on the effect of radiation on Amberlite IR-I and on some relevant solvents and solutes and by Spedding on "Heat Treatment of Uranium Metal Containing 93 and 94."

Humbert Morris of Northwestern University wrote to say he will come to work for me next June. He mentioned the offer that the Radio Research

3/19/43

Laboratory at Harvard has made him. He plans to visit me in about a month to learn a little more about his prospective job.

Vance Cooper has also joined my Section as the favorable result of my long negotiations with him, du Pont and our Met Lab Personnel Office. With the rank of Research Associate, he will work with Thompson on extraction processes in Room 4. In view of the urgency, however, he will give temporary help to Willard on adsorption work.

Helen had Charlotte Pearson, the Girl Reserve secretary, and Wilma for tea.

The seminar for chemistry Research Assistants was held as usual in my office this evening for two hours, beginning at 7:45 p.m.; however, during that time I attended the Thursday evening Research Associates meeting in Rosenwald Hall. After the meeting Burton, English, Ghiorso, Howe and I joined our wives, who were visiting in our apartment.

Friday, March 19, 1943

In the process of preparing some plutonous fluoride for use in an attempt to prepare plutonium metal by reduction with sodium, Cunningham and Werner today measured the weight change attendant with the conversion of plutonous oxide to plutonous fluoride. The solution of plutonous nitrate was delivered onto a weighed platinum weighing boat, the solution evaporated to dryness and the nitrate converted to the oxide by ignition at 800°C for ten minutes. Upon weighing the oxide and platinum boat, the weight of the oxide was found to be 4.78 micrograms. Hill then treated the oxide with gaseous HF for one-half hour at 550°C. This converted the bright yellow oxide to a dark, nearly black material and increased the weight to 5.35 micrograms. On further treatment with HF the weight was increased to 5.54 micrograms, and a third treatment caused no significant change in weight. The percent increase in weight is calculated to be 15.9%, which is to be compared with that required for the reaction

3/19/43

$\text{PuO}_2 \rightarrow \text{PuF}_4$, which is 16.5%. This gives us further confidence that we are dealing with plutonium of oxidation state four.

I sent a wire to Hamaker in Berkeley, asking that he mail a small bottle of tetramethyl ammonium bromide, which is in short supply here and needed for one of our experiments.

Wheeler came to my office this morning as he promised, and we went over the topics that he placed on our agenda. We also had a chance to discuss my memorandum that I had sent to Compton on Wednesday on the purity specifications for the 94^{239} concentrates obtained from the Site W piles.

Allison sent me a copy of a letter that he wrote to Harold Urey at Columbia University. He said, "I am forwarding to you three samples of water concentrates from the Berkeley heavy water plant operated by Professor Randall. The samples are supposed to be 25 ml each. Two of the samples are supposed to have the O^{18} reduced from the normal amount by a factor somewhere between 10 and 20. The third sample, marked 'Bottom pot No. 8,' is supposed to have the maximum increase in O^{18} content so far produced at Berkeley."

After quoting Randall on some further information about these samples, he concludes: "Fermi would appreciate it very much if you could obtain $\text{O}^{18}:\text{O}^{17}:\text{O}^{16}$ ratios for these samples. He has probably told you on his recent visit that we have succeeded in observing the activity of O^{19} by irradiating ordinary water with neutrons. By using these samples which we are sending you, after you have determined the true ratios, we may be able to work out a rapid method for the estimation of the amount of O^{18} in a sample simply by intense neutron irradiation of it."

Helen worked with Wilma at the 63rd Street Y.

Ermon D. Eastman, accompanied by Bob Connick, arrived from Berkeley on the first leg of his journey to the East Coast. Tonight they came to our apartment for dinner.

Saturday, March 20, 1943

I had a conference with Eastman, Kirk and Magel this morning on the research programs on 94 metal production to be conducted at Chicago and at Berkeley. We agreed that at Chicago we will (1) conduct microchemical experiments with microgram quantities of 94 to develop methods of producing the metal, to study its properties and its reactions with refractories, (2) study heavy metal nitride refractories, and (3) work on uranium amalgams and alloys of sodium, potassium and zinc with uranium. At Berkeley they will (1) work on electrolysis methods of producing and refining uranium and (2) study the use of sulfides such as BaS, US_2 , ThS_2 , etc., as refractories.

Knox has measured the extent of reduction of oxidized 94 by H_2O_2 at room temperature in solutions containing UNH, HNO_3 and HF for times of 0.5 hour and one hour at different HF and H_2O_2 concentrations. The rate of reaction increases with increasing HF and H_2O_2 concentrations and is apparently accelerated by the presence of a uranium peroxide precipitate.

Davidson, Miller and James, working with Thompson, have been trying to find means of oxidizing 94 in the presence of acid-dissolved bismuth phosphate at acid concentrations less than 10 N HNO_3 . In 10 N HNO_3 we have the desired small volume, but the oxidation is difficult. At lower concentrations of HNO_3 where the oxidation with a desirable oxidizing agent like dichromate ion occurs more readily, the volume is larger than desired. Their experiments during the last week have shown that bismuth phosphate containing the reduced 94 from the extraction step can be dissolved in 6 N HNO_3 and that the 94 can be satisfactorily oxidized by dichromate ion in this solution without having too large a volume--in other words, this is a good compromise. In trying to go to lower concentrations such as 4 N HNO_3 where the bismuth phosphate is not all dissolved in a reasonable volume, they find that 0.1 N dichromate ion does not oxidize the entrapped 94 from the suspended undissolved portion of the bismuth phosphate. The oxidizing agents $S_2O_8^{--} + Ag^+$ and Ce^{+4} are capable of oxidizing plutonium even in 10 N HNO_3 but these oxidizing agents are less desirable because they are not as stable under the proposed conditions.

3/20/43

Kirk has been working during the last month on the plutonium metal production problem using uranium metal as a stand-in. He has successfully reduced UF_4 , with sodium, which was distilled onto the UF_4 and produced uranium metal. Today Kirk and Rosenfels made their first attempt to produce plutonium metal. They started with about 4 micrograms of plutonium tetrafluoride, PuF_4 , prepared for them by hydrofluorination of PuO_2 by Cunningham and Brown. In their apparatus, developed through practicing with the production of uranium metal, they distilled metallic sodium onto the PuF_4 . They observed some metallic appearing product but there were complications due to the apparent partial melting of the platinum boat upon which the PuF_4 was placed. Cunningham treated the metallic looking product with 6 N HCl and thought he observed some gas bubbles. There is some doubt, however, how much plutonium metal, if any, was actually produced.

Major General W. D. Styer of War Department Headquarters, Services of Supply, in Washington, D.C., wrote a letter March 15 to Paramount Studios requesting that Baumbach be given a leave of absence. This worked where all else has failed. I wrote to Baumbach today to say how pleased I am at the turn of events.

I also sent a letter to Dreher, saying that we are all glad he is coming around April 1 and giving him advice regarding travel and moving arrangements. I suggested that he not ship the grand piano until he gets here. I concluded with the remark, "Besides Stanley Thompson, who has been here a long time, Vance Cooper is here and Harlan Baumbach is coming."

Sunday, March 21, 1943

I held a 10:30 a.m. meeting in my office of the Council of Section C-I; attending were Perlman, Willard, Cunningham, Brown, Orlemann, English and Connick (who is visiting from Berkeley). It was decided to hold separate, regular evening planning meetings for the Extraction Groups under Willard plus the Microchemistry (or Basic Chemistry) Group under

Cunningham and for the Purification plus Metal Production Groups under Perlman and Kirk. The first two groups will continue to meet on Tuesday evenings and the latter groups will meet on Wednesday evenings, the first meeting to be Wednesday of next week. The work of the past week was discussed:

Wet Fluoride Process. Reduction of oxidized plutonium by hydrogen peroxide has been restudied in the hopes of carrying out the reduction at room temperature; it has been found that 2 percent peroxide reduces the plutonium in one-half to one hour at room temperature. Arsenite has again been tested as a reducing agent. It is found that the black deposit formed on 18-8 stainless steel can be avoided by the addition of dichromate. Further work has been done on dissolving lanthanum fluoride with zirconium and aluminum, the latter having more of a tendency to precipitate from fluoride solution.

Adsorption methods. Test tube experiments have shown that when aluminum is in solution the silica gel adsorbs 100 percent of the 94 whereas only 60 percent is adsorbed in the absence of aluminum. The effect of pH on adsorption is under investigation. Fission products adsorbed on silica gel appear to be zirconium and columbium; selective elution is not quite so good as with Hyflo Super Cel. Column work has been started on silica gel using a two-inch column; channeling is severe, and adsorption is only 55 percent. Stoughton has prepared some granular zirconium phosphate to be tested for use as an adsorbent.

Phosphate extraction method. The chemical engineers have confirmed the findings that the bismuth phosphate cycle can be carried out with good yield when the bismuth phosphate is dissolved in 5 N nitric acid.

Volatility work. Brown reported that boron is removed from uranium by a factor of 10^5 using two cycles of alternate treatments with HF, H_2O-O_2, H_2 . In the separation of plutonium from UF_6 over 95 percent of the plutonium can be recovered in the residue after the UF_6 is distilled off. In treating bismuth phosphate precipitates with HF and then F_2 two percent of the gamma ray fission activity comes off with the BiF_5 and plutonium at $400^\circ C$. Plutonium fluoride has been prepared by treating PuO_2 (4 micrograms of plutonium) with HF at $400^\circ C$; two treatments increased the weight 16 percent which is the theoretical change in weight for the reaction $PuO_2 \rightarrow PuF_4$.

3/21/43

Microchemical work. Plutonium oxalate has been prepared and the plutonium determined by counting, the total weight by direct weighing and the oxalate content by titration. The best agreement with the experimental results would come from a compound of formula $\text{Pu}(\text{C}_2\text{O}_4)_2$.

Helen and I had dinner at the Paul Kirks' (5536 S. Kimbark Avenue) with their children, Mary-Elise and Anita, and with Irene and Burris Cunningham.

Monday, March 22, 1943

I attended a Laboratory Council Information Meeting on Chemistry at 10:00 a.m. in Room 209, Eckhart Hall. Others present were Adamson, Allison, Boyd, Burton, Cohn, Compton, Cooper, Elliot, Fermi, Franck, Garrison, Hilberry, Johns, Miles, Mulliken, Potratz, Spedding, Stone and Willard. Visitors attending were General Groves, and Eastman and Connick from Berkeley. Burton reported on irradiation damage tests on organic adsorption materials (amberlite) which show that Boyd's adsorption process will probably be satisfactory from this point of view for extraction, certainly for decontamination. Irradiation tests also showed no disturbance of the critical steps in the Wet Fluoride Process. Coryell reported that there are 104 known fission products; thirty new fission products have been discovered on the Project, ten in my group, ten in Coryell's group and ten at Ames. Connick stated that the sodium uranyl acetate separations process has achieved a decontamination factor of 5×10^5 , approaching the 10^7 factor needed at Site W. Spedding reported that over 50,000 pounds of uranium metal have been produced and that daily production rate has reached 1,000 pounds.

I presented a summary of work under way in my Section on the various extraction, decontamination and concentration schemes: work on the Wet Fluoride Process is mostly concerned with details; adsorption work is concentrating on inorganic adsorbents, especially silica gel and zirconium phosphate—so far the processing throughout is too slow; good progress is being made on the Bismuth Phosphate Process; for decontamination it looks promising to follow the bismuth phosphate extraction cycle with a sodium

3/22/43

uranyl acetate precipitation; purification by the Dry Fluoride Method removes boron. I described the microchemical work on the preparation of plutonium oxalate and said it now looks as if there are three valence states of plutonium, viz., +4, +5 and +6. I reported we have some evidence that about a microgram of plutonium metal has been produced from the reduction of PuF_4 with sodium. In answer to a question raised by Compton, I gave the opinion that an adsorption extraction step could be followed by a decontamination step employing any of the methods under current consideration (wet fluoride, bismuth phosphate, sodium uranyl acetate, or dry fluoride).

I had a talk with General Groves and, among other things, he asked me to prepare a short memorandum on the requirements with respect to O^{16} and C^{12} that may be necessary as we progress in our plutonium purification program.

An attempt today by Kirk and Rosenfels to reduce PuO_2 with metallic sodium vapor, using the method they used the day before yesterday with PuF_4 , gave no indication that plutonium metal is produced in this reaction.

Using his newfound skills for experimentation on the ultramicrochemical scale, Perlman today tested the carrying of plutonium by uranyl peroxide from HNO_3 solution of pH 2. In several experiments he found a carrying of about 98% of the plutonium at plutonium to uranium ratios of about 1:200.

Ted Magel is at the Globe Tube Works in Milwaukee today to help Julius M. Simmons, a Research Associate in the Nuclear Physics Division, draw uranium metal.

Clifford Smith wired C. Robert Moulton, Met Lab Personnel Director, accepting the offer to join my group on the basis of his discussion with me last Wednesday.

3/22/43

Nick Dallas started working full-time in Section C-I in his capacity as Research Assistant; previously he was on a half-time and then a three-fourths time basis.

Hamaker wrote from Berkeley, telling me he is sending the one hundred grams of tetramethyl ammonium bromide that I requested in my wire last Friday.

Eastman and Connick gave an account of the research program of the Berkeley group at the Chemistry Division Seminar this evening. Eastman described their work on the electrolysis of aqueous uranyl solutions to remove impurities from the uranium, electrolysis of non-aqueous solutions to try to produce uranium metal, measurement of equilibria in systems such as UBr_4 plus U, and work on sulfide refractories such as BaS. Connick summarized the status of their work on the Sodium Uranyl Acetate Process.

This morning Helen went to the West Side Y and later to the Girl Reserve meeting at 63rd Street in the afternoon.

Home front headlines supersede war news in today's paper; the OPA (Office of Price Administration) has stopped the retail sale of all eating oils for one week, after which they will go on rationing, as will meats and cheeses.

Tuesday, March 23, 1943

Kirk left with Eastman on their long-planned tour of uranium metal production facilities in the eastern United States (Westinghouse, Metal Hydrides and M.I.T.). Magel left Milwaukee to join them in their visits. I regret not being able to go also.

Compton wrote me a memorandum asking for a list of my proposed experiments at Site X. Although I have this work pretty well established in my mind, I will write it up formally and submit it to him within the next few days.

3/23/43

I attended the conference on adsorption in Franck's office at 2:00 p.m., along with Adamson, Boyd, Cooper, Franck, Fries, Miles, Olson, Orlemann, Russell, Schubert, Smith, Stoughton, Sutton and Willard. Progress on adsorption studies was reported by Willard, Adamson and Sutton. It was decided that Adamson will consult Garrison on the effect of radiation on glass wool and silica gel and that before the meeting scheduled for next Tuesday Boyd will call a meeting and set up one or more standard batch testing procedures.

Charles Cooper sent a memorandum to Sutton and Smith, summarizing in more detail the distribution of responsibilities for chemical extraction process development. Investigation on the semiworks scale will be carried out by Smith's Section while intermediate-scale investigations covering a wider range of possible processes will be handled by Sutton. When processes have passed through the intermediate stages in Sutton's Section, they will be turned over to Smith's Section for semiworks evaluation.

Helen went to the Metro Y.

I attended the evening meeting of the Extraction and Basic Chemistry Groups of our Chemistry Section, along with Apple, Brown, Cefola, Connick, V. Cooper, Cunningham, Davidson, Fries, Jaffey, Kohman, Orlemann, Peery, Perlman, Rosenfels, Stoughton, Thompson and Willard. The following reports were made. Dry volatility methods: Brown reported that BiF_5 has been found to carry plutonium quantitatively in the gas phase. Hydrofluorination of a bismuth phosphate precipitate containing plutonium and fission products removes 35% of the fission activity; the bismuth phosphate and plutonium may then be volatilized with fluorine leaving behind all but 2 percent of the remaining fission activity. It is anticipated this 2 percent of activity may be removed by reducing the BiF_5 with hydrogen followed by HF and fluorine treatment, this cycle being repeated as often as necessary. I emphasized the importance of making an actual experimental test of this recycling decontamination procedure soon.

Coryell displayed and discussed Wheeler's chart showing air ionization as a function of photon energy. He also gave a brief report of a

3/23/43

10:00 a.m. to 12:15 p.m. meeting he attended today where they discussed preparation of a Project handbook to summarize useful data from all branches of the Project; the hope was expressed at the meeting that I would be able to bring my table of artificial radioactivity up to date.

Cunningham reported the precipitation of plutonium in the oxidized state by sodium hydroxide; it has a solubility of 50 mg/liter in 0.5 N NaOH and is probably a sodium salt rather than a true hydroxide. It has been shown that plutonium (V) will precipitate with sodium uranyl acetate. Hydrofluorination of a sample of plutonium oxide produces an increase in weight of 16 percent, in agreement with the theoretical weight increase for the formation of PuF_4 from PuO_2 . This, however, does not serve to distinguish the reaction from that of PuO_3 to form PuOF_4 . Cunningham stated that the weight of all data now available is in favor of the formula PuO_2 rather than PuO_3 for the lower oxide of plutonium. It is planned to precipitate oxidized plutonium with hydroxide and determine the oxidation state directly by titration--iodide and ferrous iron were suggested as reducing agents. Peery and Apple said that the Wet B (Bismuth Phosphate) Process has been tested twice in the semiworks this past week using peroxide as the reducing agent. Their discussion led to the suggestion that a lanthanum fluoride cycle be used as a "cross over" step to reduce the volume before the isolation step. Coryell said he talked with Fulbright at St. Louis last night and the current fourth bombardment of uranium plus neutrons (Chicago IV) is at 140,000 microampere-hours.

After Al Ghiorso and I returned home from the meeting, Wilma and Al came up to our apartment for coffee.

Today's headline reads "Nazis' Mareth Line Dented." This is Rommel's defense line in Tunisia - the Nazis' last stand in Africa.

Wednesday, March 24, 1943

Stoughton submitted a four-page memorandum to me proposing experiments to be carried out for the purpose of testing various methods for separations of Pa^{233} from thorium; U^{233} from thorium; and U^{233} from

3/24/43

Pa²³³. It was divided into five sections: I. Volatility Methods, II. Wet Methods, III. Ether Extraction for U²³³, Th and U²³³, Pa²³³ Separations, IV. Ultramicrochemical Experiments, and V. Preparations of thorium compounds for use in conjunction with a uranium pile. A final section was devoted to a suggested order of conducting the experiments. He noted: "The ether extraction method is considered very important and it will undoubtedly be used in some part of the extraction, decontamination, purification of U²³³; it was put in Group III merely because it has already been pretty well investigated. In order to accomplish the planned work in a few months time, at least three additional men will be required."

I sent a memorandum to Whitaker commenting on the possibility of unknown radioactive constituents in the final 94^{239} product, raised in a March 9 memorandum from G. D. Graves to him. I said we are proceeding on the basis of a decontamination factor of 10^7 on the 94^{239} product to be delivered by the du Pont Company from Site W and that demonstration of such a factor is probably just within reach, using cyclotron-bombarded material. In the purification step which follows decontamination, however, there might appear constituents demanding new chemical procedures for their removal, and it is here that it may not be possible to do a great deal before we obtain the actual 94^{239} concentrate from Site W. I added that the decontamination factor of 10^7 will leave an amount of gamma radiation with the 94^{239} concentrate that would be equivalent to the gamma radiation from the 94^{239} itself if it were to emit the order of 0.001 gamma ray per disintegration. As was shown in our Report CN-299 (Report for Month Ending October 15, 1942, Chemistry of 94), the gamma-ray emission probably amounts to less than this. In proving this we have established that there is no entirely mysterious constituent that cannot be removed by existing methods from cyclotron bombarded material.

There was a Laboratory Council Policy Meeting today at 2:15 p.m. Whitaker, whom Compton has recently appointed to the Council in his capacity as Director of the Site X program so that he can keep in closest possible touch with the operations of the Metallurgical Laboratory at Chicago, was there to talk about Site X plans. Others present were Allison, Compton, Cooper, Franck, Greenewalt, Hilberry,

3/24/43

Miles, Spedding, Stone and Whitaker. Much of the discussion was concerned with construction progress and facilities to be built into the Site X pile. Greenewalt was reluctant to have hex (uranium hexafluoride) experiments carried out until after the bulk of the information needed for Site W is obtained, as he feels it would be a considerable hazard to a further operation of the pile. After some discussion it was decided that sufficient floor strength will be provided for the hex plant. There was a discussion of personnel needs for Site X; Coryell was mentioned as the one to head up the general chemistry studies; and I, or someone from my group, possibly Willard, would be in charge of the process chemistry group. Stone was asked for recommendations as to who might be in charge of medical work at Site X. It was agreed that an educational meeting of group leaders will be arranged by Cooper for March 30 to give information on what is planned for Site X.

The news today indicates that the British 8th Army has torn a hole in the Nazi's Mareth line.

Thursday, March 25, 1943

Working on the ultramicrochemical scale, today Werner precipitated oxidized plutonium with sodium hydroxide. The plutonium was oxidized by heating with $\text{Cr}_2\text{O}_7^{--}$ at 95°C for 30 minutes. The solution was then cooled and made 0.5 N in NaOH. A nearly colorless solid precipitated. The concentration of unprecipitated plutonium was about 50 milligrams of plutonium per liter as determined by alpha particle count. The precipitate was dissolved in acid, ten micrograms of lanthanum carrier added, and the reduced plutonium precipitated with HF. The oxidized plutonium remaining unprecipitated was determined by alpha particle count of the supernatant liquid. Only thirty percent of the plutonium originally precipitated was found to have remained in the oxidized state. It appears that oxidized plutonium is not stable in alkaline solution under the conditions of this experiment.

3/25/43

Today Cunningham attempted to prepare plutonium fluoride by precipitation with HF. Working on the ultramicroscale, he observes that there is no precipitation from a solution containing 2 grams of plutonium per liter in 1 N HNO_3 upon making the solution 2 N in HF. When KCl is added to a concentration of 10 grams per liter, precipitation occurs at once. This behavior is similar to that of cerium in its plus-4 oxidation state. In both cases an insoluble fluoride is formed when potassium ion is included in the precipitate.

Turk and Fries have shown that a number of specially prepared titanium oxides and phosphates show good ability to adsorb tracer amounts of plutonium. They also adsorb considerable fission product gamma activity.

I sent the following note to Langsdorf in St. Louis. "I was very interested to get your letter (of March 12) and have delayed answering because I have been hoping to arrange for English and me to take a trip down to St. Louis to talk things over with you. It may be that things will let up enough around here so that we can do this sometime next week. In any case, I will let you know as soon as possible."

Compton issued a memorandum that was directed to H. L. Anderson, W. Q. Smith, M. Burton, M. C. Leverett and me. It reads as follows:

"In conversation last Thursday with Dr. Urey, I found that he and a group of chemists working with him are actively interesting themselves in planning for a heavy water pile, cooled with hex. They are especially interested in investigating some of the corrosion problems involved in the use of hex.

"I explained to Urey that all of us here were interested in the heavy water plans and wanted as soon as our pressure of work on the water-cooled pile is released, to spend special effort in this direction. In the meantime, I noted that most of us were so completely occupied with other problems that work on the heavy water plans was being temporarily deferred. We agreed that some progress could be made by encouraging his group to do what can be done during the next few months and that this could best be started by a conference with those at this laboratory who have been studying the problem.

3/25/43

"We accordingly agreed to arrange a conference on the heavy water pile between a small group of his men and those in our laboratory who can conveniently attend on Thursday, Friday and Saturday of this week, March 25, 26 and 27. This date has been confirmed with Wigner and Urey by telegram and telephone today. The first conference will be scheduled for Thursday afternoon at 2:00."

Helen saw Stan Thompson's wife Alice in Billings Hospital where she has been since the birth of their daughter Ruth Ann on St. Patrick's Day. Mother and child are doing fine.

Helen and I went to the home of the Merlin Petersons in the evening and my friend Willard F. Libby was there. He is at Columbia University, working on the chemistry of barriers for the diffusion process for concentrating U^{235} . I was glad to have this chance to visit with my long-time friends Merlin and Marian Peterson, their six-month old son, Joe, and Joe's two older sisters. My acquaintance with Merlin and Marian dates from my graduate student days at Berkeley.

The regular weekly seminar for Research Assistants was held in my office this evening.

The biggest war news continues to come from Africa where the U. S. guns are battering Rommel's air base.

Friday, March 26, 1943

Today Kirk and Rosenfels made another attempt to produce plutonium metal using 4 micrograms of a mixed salt, $PuF_4 \cdot KF_4$, prepared by Cunningham yesterday by precipitation from aqueous solution. This was dried and in their regular evacuated apparatus, sodium metal vapor was distilled onto it, producing a product which had a gray-black crystalline (cokey) appearance somewhat like broken cast iron.

3/26/43

I received a letter from Rollefson in Berkeley, giving the first results of a spectrographic analysis of the 4-microgram sample of plutonium sent to him on March 1. A number of lines characteristic of the sample showed up on the photographic plate, seven being calcium lines and three being magnesium lines. The other lines were as yet unidentified and may be due to plutonium, which would correspond to the very first observation of the characteristic lines of the emission spectrum of plutonium. The sample was far from pure, the quantities of calcium plus magnesium being of the order of a microgram; it seems that the sample contains 25% calcium and 1% magnesium, which is not consistent with its method of preparation. Rollefson intends to make a new exposure with the 10-microgram sample he obtained from us a few days ago.

In reply to a letter I received from him last week, I sent a letter to Leonard Katzin in the Radiology Department, University of Rochester, saying I would like to have him join our group, preferably before May 1. I asked him to let me know definitely if he wants to come so that Moulton can send him the proper employment forms. Leonard was a fellow chemistry major with me at UCLA.

Eastman wrote from the Parker House in Boston, to "thank you again for the many things you did for me in Chicago and to thank your wife for her part in the hospitality." He also said that his visits to various refractory and metal production facilities are going smoothly.

James Franck today sent to Compton a summary of activities of the Chemistry Division during the last month, Report No. MUC-JF-36. I reproduce it in full because it gives a good overall picture.

"Seaborg's Section: Calculations were made on concentration of fission products in uranium solution prepared for extraction of 49.

"Distillation of bombarded UF_6 and reactions of bismuth phosphate were studied. The latter are important for decontamination of 49 if extracted by the bismuth phosphate method.

"Different phases of the wet fluoride extraction process were studied.

3/26/43

"Progress was made in the development of the bismuth phosphate extraction process. This process apparently has many advantages as compared with the wet fluoride process.

"Reactions of 49 and of 93 were investigated on an ultramicrochemical scale.

"Investigations on the adsorption method for 94 separation were carried out with silica gel and other commercial materials and specially prepared adsorbents.

"Work has been continued on methods for final purification of 49 metal, including the peroxide precipitation method and fluoride volatility method.

"Boyd's Section: The routine analytical group was occupied with analyses in connection with the Metal Production Program. Demands from the Coating Program have increased, and a small amount of work has been carried out for the Corrosion Program. The analysis of special materials for the various Physics, Engineering and Chemistry groups in the Chicago organization, and research and development of chemical, polarographic and spectroscopic analysis methods have continued. Physical methods (i.e., the "Shot-gun" test) were employed to give an integration of any impurities missed by other procedures.

"Important experimental details in the separation, decontamination and waste liquor disposal in connection with the adsorption method were studied. The use of amberlite and zirconium phosphate as adsorbents gave good results.

"Burton's Section: Results of irradiation of amberlite indicate that the use of this resin will probably be satisfactory for Boyd's separation method, and certainly satisfactory under decontamination conditions, if it can be used for the latter process. The fluoride method of separation (Seaborg) is satisfactory from the radiation point of view.

"Work on insulators has been begun and is proceeding rapidly, as is the work on hydrocarbons.

"Experiments on irradiation of water show that deuterons produce hydrogen peroxide in water even in the absence of O_2 , whereas β 's and γ 's require oxygen or I^- or Br^- as a catalyst. Cl^- works as a catalyst only at concentrations far in excess of those which could be expected

3/26/43

under natural conditions. Progress has been made on the interpretation of the mechanism of these reactions.

"Coryell's Section: Further measurements on the nature and half-life of fission products, together with yields and energies of β and γ radiations were made and all data, new and old, were compiled. All prominent radioactive materials affecting the separation problem are known (20 isotopes of half-life longer than 5 days distributed among 14 of the 22 known fission elements). The search is going on for long-lived constituents of low yield and of elements of short life. Further work is in progress on the very short-lived activities affecting pile heating. The nature of cyclotron fission and capture has been studied in detail. Preliminary studies have been completed for the West Stands pile, from which the ratio of fission to capture and the wattage by chemical methods was measured.

"Ames Project (F. H. Spedding): The research work at Ames was devoted to (1) spectrophotometric determination of Fe in the presence of much Ca and Mg (the method is useful for analysis of Ca and Mg to be used in the production of uranium metal); and (2) studies of reactions between hydrogen and uranium metal at higher temperatures carried out for the purpose of finding out whether the reversible uranium hydride formation can be used to separate uranium from fission products.

"Berkeley Group: Studies of the sodium uranyl acetate method for extraction and decontamination of 49 were continued. It was possible to reduce the fission activity by more than a factor of 10^5 in three cycles. In connection with this work studies were made on 49 metal."

I signed papers today for patent case S-53 entitled "Extraction Method for Separating Foreign Products from Compositions Containing said Products and Radioactive Elements," which includes basic claims to the method of separating element 94 from uranium and fission products by organic solvents such as ether using the oxidation-reduction principle.

Helen visited some Girl Reserve mothers in their homes. In the evening we saw "Casablanca," featuring Ingrid Bergman, Humphrey Bogart and Paul Henreid at the Picadilly Theater at 51st and Blackstone Streets.

3/26/43

In Africa the war situation is not so good as it was at the beginning of the week, but the situation seems to be temporary, and the Allies apparently will be moving again soon.

Saturday, March 27, 1943

Brown, Hill and Bohlmann have found that when a bismuth phosphate precipitate incorporating 94 and fission products is hydrofluorinated and then fluorinated that the volatile higher fluoride of plutonium goes along with the higher volatile fluoride of bismuth. They have found that the fission product gamma activity associated with the collected bismuth fluoride and plutonium fluoride is about 2% of the activity initially present in the bismuth phosphate precipitate. If it is assumed that the bismuth phosphate brings down about 10% of the fission activity in two-month old fission active uranium, the initial precipitation combined with one dry fluoride volatilization will achieve an overall decontamination factor of 500. It might be possible to continue a dry decontamination cycle further than one volatilization. The bismuth fluoride and plutonium fluoride might be reduced with hydrogen, then treated again with HF to remove more of the volatile fission activity. Then, if this is followed with another volatilization with fluorine, it should be possible to obtain a further decontamination factor from gamma activity. Their experiments show that this is true and that a second volatilization produces additional decontamination from gamma activity of about a factor of 50. This gives an overall decontamination factor for one bismuth phosphate precipitation and two volatilizations of 25,000 (Figure 30).

James has conducted successful oxidation-reduction cycles for the Bismuth Phosphate Process using neutron-bombarded UNH. This material corresponds to 60 days after shutdown of a 60-day St. Louis cyclotron neutron bombardment. The key to his success is the use of 6 N HNO₃ in the oxidations. He started with 20% UNH and 1 N H₂SO₄, 2.5 mg per cc of Bi⁺³, 0.4 M H₃PO₄ and worked with a total volume of 800 cc. The bismuth phosphate was precipitated at 90°C and heated for two and a half hours before it was filtered. The precipitate was washed and then dissolved in

3/27/43

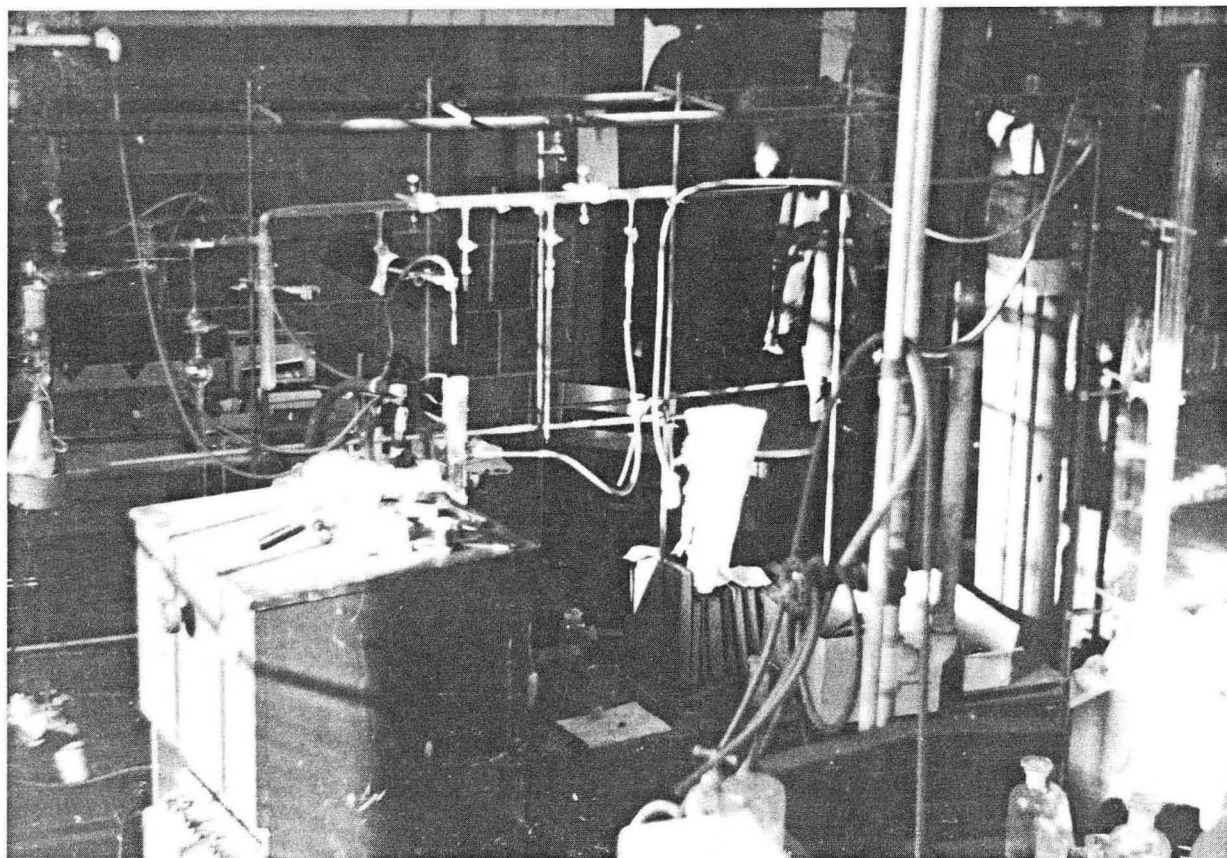

Fig. 30. Dry fluoride volatility apparatus of Brown, Hill and Bohlmann, Room 2, New Chemistry Building, early 1943. (XBB 768-7449)

3/27/43

10 N HNO_3 which was diluted to 6 N HNO_3 where oxidation with 0.1 M dichromate ion took place by heating the solution at 95°C for two hours. This solution was diluted and H_3PO_4 was added to precipitate bismuth phosphate by-product at 90°C . The bismuth phosphate by-product precipitate was removed by filtration, and then the filtrate was treated for five minutes with SO_2 gas after which it was allowed to stand for one-half hour; then the solution was heated again to 90°C and Bi^{+3} was added in order to precipitate bismuth phosphate. After one-half hour digestion at 90°C , the bismuth phosphate was separated by filtration and analyzed for its alpha, beta and gamma activity. The yield of plutonium was 98% and 0.08% of the original fission product beta activity and 0.27% of the original fission product gamma activity was found. In another experiment in which by-product zirconium phosphate and barium sulfate and strontium sulfate were precipitated from the oxidized solution, similar results were obtained—namely 95% recovery of plutonium with 0.10% of fission product beta activity and 0.07% of fission product gamma activity. Balthis of the Separation Processes Section of the Technical Division has performed similar oxidation-reduction cycles with equally encouraging results.

Cunningham made tests on the material prepared yesterday by Kirk and Rosenfels, which might contain at least some plutonium metal. Although it didn't react with alcohol, most of it seems to dissolve in 6 N HCl with the evolution of hydrogen gas and counting of the alpha particle activity shows a total of 0.4 microgram of plutonium; it is not certain that this proves that plutonium metal was produced because the hydrogen evolution could be caused by something like entrapped sodium.

Dr. Joseph J. Katz started to work as a Research Associate in Section C-I today, coming from the University of Chicago where he has been working on an OSRD project concerning uranium chemistry directed by Professor Herman Schlesinger. I am particularly pleased that a man of his training and ability is joining us, and I plan to have him start with work on plutonium extraction processes. However, I intend to have him work later on the plutonium purification problem and am asking him to work in Room 6 where Perlman and Orlemann are situated.

3/27/43

Louis Strait wrote to me from San Francisco that he will be able to join me here at the Met Lab, but not before late June or the first of July. He raised the question of doing some of our work in his laboratory in the College of Pharmacy, which serves the entire University of California Medical Center in San Francisco. He inquired if it might not be possible for him to fly here for a week or so for preliminary instruction so that he will be able to develop some experimental spectroscopic techniques while still in California.

I sent a letter to Humbert Morris in Evanston agreeing that he should visit me and talk things over. I told him that I discussed his starting salary with the Laboratory Director, but rules will not permit matching the other offer he received from the Radio Research Laboratory at Harvard.

Helen and I had dinner at the John Howes', together with the Harrison Browns, after which we all went dancing at the Trianon Ballroom, on Cottage Grove Avenue near 63rd Street, to the music of Eddy Howard.

Sunday, March 28, 1943

I attended the 10:30 a.m. meeting in my office of the Council of Section C-I. Others present were Perlman, Willard, Kirk, Cunningham, Brown, Orlemann, English and Eastman (who, along with Kirk, returned at nine o'clock this morning from his trip to visit metallurgical laboratories in the eastern United States). I reported that corrosion studies by the Technical Division show a tolerable corrosion rate for 25-12 stainless steel at room temperature in the presence of 1.5% HF. The report of Sutton at the regular Technical Division meeting on Friday evening was described. He and Balthis reported on their good results on the test of oxidation-reduction cycles on the Bismuth Phosphate Process. He and Olson reported on their work on the amberlite adsorption method, stating that they have found considerable difficulty, particularly in the elution from the amberlite and they have found poor decontamination from the fission product activity. At the Friday evening meeting Sutton placed

3/28/43

a diagram on the board making comparative evaluations of the Adsorption, Bismuth Phosphate and Wet Fluoride Processes and gave the Bismuth Phosphate Process the highest rating with Wet Fluoride second and Adsorption third. Brown reported on decontamination work on bismuth phosphate by dry methods, the method consisting of taking the bismuth phosphate precipitate from the extraction step, treating with HF at several hundred degrees, fluorinating at 500°C, condensing the BiF_5 and PuF_6 , treating with H_2 and repeating the process. A decontamination factor of $2.5-3 \times 10^4$ was achieved through two such fluorinations.

The extraction and decontamination program to be started in the next week was outlined: (1) Experiments will be carried out to test decontamination of fission product containing bismuth phosphate by bismuth phosphate cycles, by sodium uranyl acetate cycles and by dry methods. (2) Neutron-bombarded material will be put through several wet fluoride cycles to test decontamination. (3) In the adsorption studies, the effect of complexing the uranium with sulfate and the effect of increasing temperature will be tested. (4) English will prepare a proposal for methods of control work for Sites X and W. We have requested that material from Site W be decontaminated in gamma ray activity by a factor of 10^7 . In order to justify this degree of separation from fission products the gamma radiation from the plutonium itself must be very low—0.001 gamma ray per disintegration of 49 will give the same radiation level as the 10^7 decontamination factor from products.

Kirk and Eastman reported on their trip in the East where they visited the following establishments engaged in metal production: Westinghouse Company, Metal Hydrides Company, and M.I.T. Cunningham reported that he has observed gas bubbles when microgram amounts of "plutonium metal" were treated with HCl thereby giving some indication, but not proof, that metal has been prepared.

I have decided that Perlman is the man to be in charge of our Chemistry Group or Section at Site X. I talked with him about it, and he is willing to do it if this is my wish. This means, then, that John Willard will be the man to be in charge of our Chemistry Group at Site W.

Helen and I went to a movie this evening.

Monday, March 29, 1943

Miller completed today successful tracer experiments with the combined Bismuth Phosphate and Sodium Uranyl Acetate Processes. Using as starting material neutron-bombarded UNH, he precipitated the reduced plutonium with bismuth phosphate and then dissolved this in HNO_3 and performed the oxidation with dichromate ion in 6 N HNO_3 . The excess phosphate ion was removed by precipitation as zirconium phosphate; the solution was diluted to 1 N HNO_3 , NaHCO_3 added to give a pH of 1.5, the solution boiled to coagulate the precipitate and drive off the CO_2 , and then the zirconium phosphate precipitate was filtered off. UNH, NaNO_3 , HAC and NaAc were added to the filtrate in order to precipitate sodium uranyl acetate to carry the oxidized plutonium. This precipitate was dissolved in 3 N HNO_3 , the acidity lowered by the addition of NaOH, and the oxidized plutonium was reduced again by the addition of $\text{NH}_2\text{OH}\cdot\text{HCl}$ and sodium uranyl acetate again precipitated by adding UO_2^{++} , and excess sodium acetate and this precipitate was removed by filtration. Analysis of this filtrate showed a recovery of 92% plutonium with less than 0.1% of the fission product activity.

Today Davidson showed that plutonium can be carried to an extent of 99% on bismuth phosphate precipitated in the absence of uranium from solutions in which the concentration of Bi^{+3} is only 0.1 mg per cc. This is important for the steps following the initial precipitation of bismuth phosphate from the initial UNH solution in the Bismuth Phosphate Process.

The work on the Bismuth Phosphate Process during the last couple of weeks indicates great promise for its use in the actual plant-scale operation at Site W. Present plans are that the piles at Site W will run at a power output of 2,500 kw per ton. If 100-day operation of the pile is assumed, the plutonium concentration in the uranium should be about 250 grams per ton or about 50 mg of plutonium per liter of solution prepared for the initial phosphate precipitation. Thus the ratio of plutonium to bismuth would be approximately 1:80 by weight in the initial phosphate extraction step. The concentration of plutonium would be of the same

3/29/43

order as the solubility of plutonium phosphate; and, therefore, it is possible that part of the plutonium phosphate would precipitate without a carrier in the extraction step. This should cause no problems but probably should be checked out in future experiments. The ultramicrochemical experiments have shown that the carrying power of bismuth phosphate for high concentrations of plutonium in the presence of uranium is satisfactory at plutonium to bismuth ratios of 1:100 but decreases appreciably when the ratio is greater than this. There should be no problems at Site X where the pile will probably operate at 15 kw per ton of uranium. Remaining to be perfected, of course, are the further oxidation-reduction cycles in the Bismuth Phosphate Process in order to reduce the fission product beta and gamma activity to acceptable levels.

Henry Taube received his Ph.D. in chemistry from Berkeley in 1940 and served as an instructor while I was there. Now he is at Cornell University in the same capacity. Today I received a wire from him that he will arrive in Chicago this coming Wednesday and will meet me at the Lab. I hope I can convince him to take a job with us.

Langsdorf sent a note from St. Louis, which arrived today. It said: "I do hope you and English can come next week. And do not forget about the newly increased yardage of red tape if you need to get into the cyclotron. However, all my apparatus is in the physics building, tho the chemistry lab is in the cyclotron."

Magel returned from his visits to the various uranium metal production sites early this afternoon.

I received a letter from Saul Winstein at UCLA, apologizing for the delay in answering my letter, partly because of illness of both him and his wife, Sylvia. He said that the situation there is very much unchanged and that the teaching program will continue and may increase with Army and Navy demands in July. Also he has become involved in an anti-malarial program that was assigned to his department. Unless matters change suddenly he does not think it will be desirable to come with me. I replied by letter to Saul, saying I will be in South Gate, California, on

3/29/43

Sunday afternoon. I suggested he call me at that time to discuss the latest developments on the possibility of his coming to Chicago; I have some very good arguments for him.

I sent a letter to Louis Strait at the University of California Medical Center, indicating it will be agreeable to us for him to come with us in June or July. I said that I shall be in Berkeley next week and suggested he come to see me at the Department of Chemistry on Tuesday to talk about the whole matter.

I also notified Emilio Segrè in Berkeley of my impending visit there from Monday to Thursday of next week. I said we will have an opportunity to talk over the patent matter on which he is working (i.e., writing up proposed methods of producing energy by the use of 94^{239}).

Another letter went to Baumbach in Pacific Palisades, California, saying we are looking forward to his arrival on Sunday, April 11, and inviting him to come directly to our apartment at 6128 Woodlawn Avenue, telephone Fairfax 2338. I mentioned that I will be in South Gate on Sunday and suggested he might want to call or come out to South Gate for a talk, although he might consider it unnecessary in view of the fact we will meet in Chicago just a week later.

I received a copy of a memorandum from C. M. Cooper to Stone and Franck, marked attention Wollan and Coryell, raising the problem of possible evolution of 8-day iodine during the metal dissolution step in the separations process and suggesting that studies be made to determine how much of the material would be liberated.

Today I participated in the heavy water conference, originally scheduled for last Thursday. Urey and Libby from Columbia were present, as well as Abbott, Allison, Anderson, Brown, Burton, Crist, Christy, Compton, Fermi, Friedman, Hilberry, Howe, Leverett, Miles, Ohlinger, Vernon, Weinberg, Wigner and Young. The purpose of the meeting was to allocate tasks among persons and groups relative to investigations of a

3/29/43

pile fueled by liquid uranium hexafluoride and moderated by heavy water. Compton presided over the discussion concerned with the design of the system, methods of preventing corrosion by the uranium hexafluoride, etc. Urey then took the floor and presided over a discussion on those physics and chemistry experiments that should be performed.

I had a conference with Borst on the schedule for the Site X reactor start-up. It is somewhat as follows: Start July 15, 1943, and operate at 0.1 watt for two weeks, during which time a determination will be made of the percent of delayed neutrons and studies will be conducted on barometric, humidity and shielding effects. The power level will then be raised to 1 kw for measurements of air flow activity and distribution of activity relative to the stack. Beginning August 7, when the pile will operate at 100 kw for a week, the pile temperature will be checked, among other experiments. The first discharge of metal will take place August 15; the daily discharge will commence August 25; and full-scale operation will be in effect by September 15. It will be interesting to see if we can follow through on this optimistic schedule and whether there will be unexpected foul-ups.

Helen went to the West Side Y in the morning and a Girl Reserve meeting later.

Spedding's people held the stage at the Chemistry Division seminar this evening, with talks by Spedding on the use of magnesium as a reductant for UF_4 to produce uranium metal and the production of uranium hydride (of which he displayed a sample) and by W. H. Sullivan on gamma-ray scattering. Compton was there, too. Joe Kennedy is in town with his wife Adrienne, and he also attended.

Allied movements have picked up in Africa, and U. S. troops drove 20 miles in Tunisia in one day.

Tuesday, March 30, 1943

Langsdorf sent me the following telegram: "Please wire whether you are coming because if not I will arrange to come to Chicago the end of the week." I sent a return wire that my plans have changed and that I am going to California this Friday, but that I will be happy to see him here any time before this.

I attended the 2:00 p.m. conference on adsorption in Franck's office, along with Adamson, Boyd, Cooper, Franck, Miles, J. H. Peterson, Schubert, W. Q. Smith, Squires, Sutton, and Willard. Plans were made to test the effect of changes in physical dimensions of adsorption columns filled with amberlite IR-1 resin. It was also agreed to test the effect of temperature on adsorption and elution. The next meeting is scheduled for Tuesday, April 6, at 2:00 p.m. in Franck's office.

I submitted a memorandum to Compton outlining the duties of the 20 men from the "Chemistry of Final Products" section who will be at the Site X laboratory. Besides assisting the semiworks people with development work and trouble-shooting in the extraction plant, they will work on decontamination studies since there will be sufficient fission products present to give final answers on the extent of decontamination possible. There will also be some microchemists to prepare samples of the progressively increasing amounts of plutonium for shipment to Chicago and elsewhere. Other problems to be handled will be (1) development of methods for extracting protoactinium and uranium-233 from the thorium salt to be irradiated in the pile; (2) to attempt the extraction of 93^{237} as a means of determining the yield of the $n,2n$ reaction in the operating pile and to obtain samples for chemical studies; (3) the development of methods for separating plutonium from the UF_6 tubes to be operated in the pile.

An interesting report entitled "Report for the Month Ending March 27, 1943. Technology—Chemical Engineering and Separation Processes" (No. CN-544), is being issued covering work of the Chemical Engineering (semiworks) Section under W. Q. Smith and of the intermediate scale Separation Processes Section under J. B. Sutton. In the part written by

3/30/43

Smith, "Chemical Engineering Section," they report that the major difficulties in adapting the Wet Fluoride Process to larger scale plant-type equipment have been overcome on the basis of their semiworks scale experiments. Modifications in the process have been worked out which allow its operation even in 18-8 stainless steel equipment, thus the question of corrosion of 25-12 stainless steel plant equipment seems to have been definitely settled since this material is considerably more resistant to corrosion than 18-8. Some work is also reported on the Bismuth Phosphate Process. Plutonium has been successfully extracted by the precipitation of bismuth phosphate from one 30-pound and two 60-pound batches of St. Louis bombarded uranyl nitrate and the report states that this product was turned over to my Section. Sutton's Section describes their work on the separation of plutonium by adsorption using columns packed with amberlite IR-1 (an ion exchange resin) and columns packed with zirconium phosphate. Although adsorption has been found to be rapid in the case of these adsorbents, difficulties have been encountered in desorption of the plutonium and the separation of the plutonium and fission products. Working on the large beaker scale, Balthis has run a successful oxidation-reduction cycle on the Bismuth Phosphate Process using dichromate in 6 N HNO_3 as the oxidizing agent and finds about 97% recovery of plutonium with reduction of the beta and gamma activity to 0.1 and 0.1-0.3% respectively of their original values. He performed these cycles in the presence of 25-12 stainless steel and did not find any adverse effects. It is stated that additional semiworks tests of the Bismuth Phosphate Process will be carried out in the immediate future.

Helen went to a Public Affairs Committee meeting of the Loop Y and shopping with Wilma Ghiorso.

M. D. Whitaker, who is Director of the project at Site X, and Charles Cooper, Director of the Technical Division here, gave talks tonight summarizing the planning that is going on for construction of the pile, chemical extraction plant, etc., there.

Today's war news indicates that the Axis is in serious trouble in Tunisia and is in retreat.

Wednesday, March 31, 1943

I participated in a conference on the current status of the Bismuth Phosphate Separations Process. Others present were Balthis, Brown, Davidson, Perlman, W. Q. Smith, L. Squires, Sutton, Thompson and Willard. Points still to be investigated in the process were identified, including (1) microchemical studies on the carrying power of bismuth phosphate for plutonium from uranium-free solutions, the physical properties of plutonium phosphate precipitates and the solubility of the phosphate of oxidized plutonium in uranium-free solutions; (2) radiation effects (with Burton's group); (3) effect of fission product elements at Site W concentrations; (4) the effect of several cycles in effecting decontamination. Among the points mentioned in the course of the discussion were (1) carrying power of bismuth phosphate will be adequate for all concentrations of plutonium to be met at Site X, but must be investigated for Site W concentrations at all points in the process; (2) it is important to consider a 93 separation because the first material produced at both X and W will be processed soon after removal from the pile. Furthermore, even though the proposed cooling period of 60 days at W will make the 93^{239} activity very low, some 93^{237} will remain and eventually must be separated from the plutonium; (3) in coupling the Sodium Uranyl Acetate Method with the Bismuth Phosphate Method it seems important to remove phosphate from solution before the acetate precipitation in order to prevent uranyl phosphate from precipitating, which presumably would carry fission activity; (4) it is possible to reduce the amount of bismuth carrier to half of that now specified for the extraction step (i.e., to 1.2 grams/liter), and in the absence of uranium it is possible to carry 94 with as little as 0.1 gram/liter of bismuth.

Yesterday and today Cunningham, Werner and Cefola made a calibration, using a platinum weight, of the Kirk-Craig quartz fiber torsion balance against our Ainsworth balance. A weight of 175 micrograms, as determined on the Ainsworth balance, gave a deflection of 438.3° on the Kirk-Craig balance; this corresponds to a sensitivity of 0.399 microgram per degree.

3/31/43

Covey has been busy the last week conducting the property inventory required in connection with transfer of the Project from OSRD to the Army.

Joe Hamilton, from Berkeley, and Alex Langsdorf, from St. Louis (in response to my wire yesterday), are in town which gave us a chance to talk about scheduling of cyclotron time at Berkeley and St. Louis in a meeting this afternoon which also included Franck, Coryell, Boyd and Burton. Kennedy, in town, told us of the increasing need of Oppenheimer's Site Y program for cyclotron bombardment time, a serious competitor to our use of the two cyclotrons. We therefore discussed means of increasing the efficiency of Pu²³⁹ production in bombardments with cyclotron neutrons by better arrangements of uranium, such as uranium metal, UO₂, and uranium-hydrogen mixtures.

Henry Taube visited me from Cornell University, Ithaca, New York, to discuss the possibility of joining Section C-I. He is definitely interested in transferring here but there is a problem of getting security clearance, as he is a Canadian citizen.

Robert L. Patton started work as a Research Associate in Section C-I, coming from Cornell University, where he has been an instructor in the Department of Entomology. I am suggesting that he work in Room 10 with Cunningham, in view of his experience with Kirk at Berkeley in micro-chemistry, and that he test the carrying of 94 by bismuth phosphate, in the absence of UNH, at Site W concentrations of 94. This is an important aspect of the Bismuth Phosphate Process that needs to be investigated.

Baumbach sent me a letter from Hollywood on a Paramount Pictures letterhead. "Well," he wrote, "the house is rented, the car is sold, the tickets are bought and all that remains is to finish up the work here. The company has invested rather heavily in some research on a new color process, and I have to get the chemistry of it as well organized as possible before I leave. Also the regular routine running of the department has to be gone over carefully with my assistant." He asked for the name of a conveniently located hotel and mentioned that Leonard Dreher had called before he left and was very enthusiastic

3/31/43

about joining our Project. I sent him a wire suggesting the Mayflower Hotel at 6125 Kenwood as a good place to stay.

I sent a memorandum to General Groves as he requested, outlining possible requirements for O^{16} and C^{12} that might be needed in connection with our plutonium purification program. The main use for either of these isotopes would be to prepare refractory materials for making the plutonium metal, e.g., zirconium dioxide or graphite crucibles, the object being to eliminate from the final product the isotopes C^{13} , O^{17} and O^{18} , which undergo the α, n reaction with higher yield than O^{16} or C^{12} . I recommended that C^{13} be reduced by a factor of 100 and O^{17} and O^{18} by a factor of 50 each. I estimated the quantities of enriched O^{18} and enriched C^{12} needed would be equal in weight to the amount of plutonium metal to be processed. I emphasized that I do not think it is yet possible to decide whether or not these enriched isotopes will be necessary, the principal uncertainty being the lack of information as to the nature of plutonium metal. In conclusion I pointed out that work on metallic plutonium is now progressing on the microgram scale in order to obtain such information as is possible, which, together with the determination of the yield of neutrons from the reaction of alpha particles with C^{13} , O^{18} and O^{17} , will help to decide whether or not the enriched isotopes will be needed.

I attended the evening meeting (our first) of the Purification and Metal Production Groups of Section C-I, held in my office. Present were Brown, Cefola, Cunningham, Davidson, English, Ghiorso, Katz, Kirk, Kohman, Magel, Orlemann, Patton, Perlman, Rosenfels, Thompson and Willard. The following topics were covered:

Reasons for purification program. I discussed the α, n reaction on light impurities, pointing out that the danger in having too many neutrons present is that it will be impossible to bring together the two or more subcritical masses of metal in a short enough period of time; in such a case there would be a repulsion of the masses before the fast neutron chain reaction could be propagated so that only a very insignificant explosion would result.

Organization. The work of the purification group can be classified under physical measurements, analytical measurements and microchemistry. The work of the metal production group will embrace work with plutonium on the microscale, practice techniques with uranium and special refractories.

Amounts of plutonium. According to present expectations we will be dependent on St. Louis cyclotron material until August or September at which time milligram amounts will begin coming in from Site X. In December gram amounts might be available from Site X. In April 1944 large amounts on the production scale should become available from Site W, at which time the final methods of purification and metal production will have to be settled as quickly as possible.

Suggestions for near future work. (1) Volatility of fluorine compounds using uranium on a microscale to test the separation from beryllium; (2) development of microcollection apparatus for volatility work with microgram amounts of plutonium; (3) the preparation and density determination of plutonium metal; (4) preparation of refractories such as uranium nitride. Also, the alloying of plutonium with mercury and bismuth might be tested as a means of separating the oxide or carbide in a slag phase.

There was a Laboratory Council Policy Meeting at 10:00 a.m. attended by Allison, Compton, Fermi, Franck, Hilberry, Jeffries, Miles, Spedding, Stone, Whitaker and Wigner. Compton gave one of his "State of the Nation" talks. He stated that the overall schedule of the Met Lab as projected May 20, 1942, has slipped. The first gram of 94^{239} is now expected in October 1943 rather than April 1, tomorrow. It is doubtful if the original goal of many bombs by January 1, 1945, can be met, although there should be sufficient material available for the production of several bombs by that day. One of the delays he cited was caused by changing from helium to water cooling of the production piles. Compton agreed, however, that production might be ahead of schedule because we are now proceeding to build at once for full production.

Whitaker was the next to speak. He talked about the schedule for Site X and said that we are now "over the hump" on design and

that foundations for the chemical separations plant and pile will be started in about a week. With regard to the move to Site Y, Allison announced that a large contingent of persons has now joined Oppenheimer at Santa Fe (principally from California and from Princeton). Oppenheimer wants to expand the personnel as fast as possible. John Manley will leave the Met Lab for Site Y on May 1, and Allison expects to move there permanently on June 15. Other matters taken up at the meeting were related to a health monitoring committee, a training program for personnel not to be assigned to Site X, and shielding experiments at Argonne Laboratory.

As March comes to an end, Rommel's forces are in serious trouble in Tunisia.

APRIL 1943

Thursday, April 1, 1943

I wrote a memorandum to Moulton explaining what an outstanding inorganic chemist Henry Taube is and said that he would immediately become a key man in my Section. I asked that he be offered a position and given clearance so that he can come to work with us before his final United States citizenship papers are granted, for which he has already filed.

Roy H. Beaton started work as a Research Associate in Section C-I today, having been assigned to us by the du Pont Company for whom he has been working in Waynesboro, Virginia. The assignment came about as a result of my correspondence with him, culminating in a discussion I had with Greenwalt where I indicated our need for Beaton's talents. He has experience in the adsorption method, and I plan to have him work in this part of our program and act as a leader in it. He will make his headquarters in Room 11.

Irving Sheft also started working in Section C-I as a Research Assistant, coming from the University of Chicago where he has been working on uranium chemistry under an OSRD contract with Professor Schlesinger. I am asking him to work with Willard in Room 11 on the adsorption extraction method.

I received a wire from Dreher saying that he will arrive in Chicago Friday, 7:30 a.m., on the Santa Fe Limited. Moulton showed me a letter from Dreher's former employer, the General Petroleum Corporation of California, that I read with some amusement: "I understand that Mr. Dreher is joining your staff, to which we have no objection. However, his taking service with you is on the basis of a resignation from General Petroleum, because we cannot conceive of any war problem of any greater importance than that on which Mr. Dreher is engaged in his duties with this Company.

4/1/43

Just as you have a great urgency for properly qualified men, the same is true of the oil industry, in which there are many companies building high octane plants and pursuing research in petroleum products."

Compton sent a monthly report to General Groves, to which he attached separate condensed reports for March 1-April 1 of the four Research Divisions of the Metallurgical Laboratory, of its Administrative Office, and of the Director of the plutonium operations at Site X. It is an interesting document because it shows how much progress has been made since I arrived here last April a year ago, and how deeply we are involved in the production of ${}^{94}\text{Pu}^{239}$. Although lengthy, I will quote it in its entirety.

PROGRAM

Du Pont has selected the water-cooled plant, based on the laboratory's report CE 407, for the producing unit. The laboratory is placing its primary emphasis on solving problems essential to the design and construction of this plant.

A preliminary survey of the possibilities of a heavy water plant has been made in collaboration with Dr. Urey and others from Columbia University. Exploratory design work and basic physical and chemical experiments have been planned, which will enable the heavy water to be used for "49" production as soon as it becomes available.

It is planned to postpone study of the methods of utilizing the power from the chain reaction process until the problem of "49" production is well in hand, which is expected to mean at least six months.

Other major problems under consideration include (1) physical and chemical studies necessary to assure the satisfactory quality of the "49" as produced for the military objectives before us, and (2) methods of separating radioactive by-products and preparing them in a form suitable for military use.

ORGANIZATION

At the urgent request of the U.S. Engineers, the University of Chicago has agreed to operate the semiworks "49" plant at Site X, with the collaboration of the du Pont Company for its design and construction, and in supplying personnel. Dr. M. D. Whitaker of the Metallurgical Laboratory has been appointed as the director of this plant,

responsible to the Director of the Metallurgical Laboratory. His staff, composed chiefly of Chicago and du Pont men is being organized. The "49" plant at X will supply engineering and scientific information and experimental quantities of our product.

In planning for the increased work of the Metallurgical Laboratory, after careful consideration of the effect of transferring operations to more commodious quarters to be built at Argonne Forest, Site X, or Site Y, it was agreed that the work should remain centered at the University of Chicago, with, however, a concentration of the research facilities in buildings which can be more adequately guarded than those now in use. This decision was necessary to make possible the most prompt and adequate answers to the problems which the Laboratory is now being asked to solve. Major Peterson, with the counsel of Dr. Hilberry, is proceeding with the building changes required thus to house the research project in the University buildings.

RESEARCH PROGRESS

The reacting pile erected and operated by Dr. Fermi on the campus of the University of Chicago has been moved to the Argonne Laboratory and set in operation there. The success in making this reconstruction confirms our confidence that we can predict the action of the pile.

A lattice of graphite and tubealloy (uranium) wrapped in paper, closely approximating that planned for the water-cooled production unit, has been tested in an intermediate pile. Its multiplication factor is found to be slightly more favorable than assumed in designing the water-cooled plant.

The fluoride process for extracting the "49" from the treated tubealloy has been given a successful semiworks test, and has been found unaffected by intense radiation. The new adsorption method of extraction, which should be much simpler for operation by remote control, has been found to be somewhat affected by radiation, but several hopeful methods of reducing the radiation effects to negligible proportions are being tried. Plans are complete for a semiworks test of this new method.

The extrusion method of fabricating rods of tubealloy has produced successfully 1200 pounds of good product. Rolling has also been demonstrated as a possibility.

4/1/43

Calculation shows that the normal production process as planned at W should nowhere contaminate the air with radioactive materials beyond healthful conditions if the extraction is delayed at least 30 days after completion of the pile operation. Similar calculations, as yet provisional until the exact conditions of operation are set, indicate that no serious contamination of the river water will be caused by its use for cooling the power units.

TIME SCHEDULE

The date of April 1, 1943, for production of the first gram of "49" estimated in a memo to Dr. Conant dated May 20, 1942, is not met. This delay is due primarily to two changes, made against our recommendations, in the plans to carry on the necessary operations at Argonne Forest and to delay in preparing Site X for our work. At present, October 1943 appears to be a probable date for the first gram to be produced at Site X.

The date of January 1945 for the production of bombs at a useful rate, estimated in the same memo, still seems possible of achievement if the production plant at W is pushed hard and does not become unduly complicated, and if the six months delay in obtaining the first experimental gram does not seriously delay development of methods of using our product.

SUMMARY OF ACTIVITIES OF PHYSICS DIVISION (E. Fermi)

Reacting Pile: The pile in the West Stands has been taken down and reassembled in the Argonne Laboratory. The new pile has already reached the critical dimensions. Work is still in progress to complete the shielding, to install control and safety rods and to put the measuring equipment in shape. It is expected that this work will be completed by April 15.

Theoretical Group: Consultation work with the du Pont engineers on water cooled plant. Theoretical calculations on various designs of radiation shield.

Exponential experiments: Three experiments were performed by the Stearns, Froman, Christy group. One with 6 pound metal lumps in an 8-inch cubic lattice confirmed previous results on the same lattice. Two experiments were made to test rod geometries with and without

4/1/43

hydrogenous material surrounding the rod. The results were in general agreement with the theoretical expectations.

A number of diffusion length measurements were performed on graphite.

The group has now moved to the West Stands.

Cyclotron group: Work has been continued on the fast neutron reaction in metal. Samples of separated isotopes are now being investigated inside the large metal pile.

Bloomington group: Work has been completed on the resonance absorption in UO_2 as a function of the temperature. The result indicates a slight increase (about 1 percent at $100^{\circ}C$) of the absorption with increasing temperature and confirms the results obtained from the reacting pile. The experiment will be repeated on a metal lump and is expected to be completed in two weeks.

SUMMARY OF ACTIVITIES OF TECHNICAL DIVISION (C. M. Cooper)

Chemical Process Development: The various difficulties which arose in the early semiworks operation of the Wet Fluoride separations process as planned for Clinton Engineer Works (Site X) have been largely resolved, and a satisfactory process is now believed to be assured. One other process (bismuth phosphate) which offers some advantages over the wet fluoride and which could be worked in wet fluoride equipment is ready for semiworks evaluation.

Instruments and Control: Research toward development of new radiation measuring equipment for Site X and W is progressing rapidly. Definite plans are made for the X equipment. Detailed plans for pile control mechanisms are well underway.

Metallurgy: Successful manufacture of over 1200 pounds of metal rod by extrusion has demonstrated the industrial feasibility of this fabrication method. Protective coatings for the metal have narrowed down to aluminum jackets (for W) and methods of application are receiving intensive consideration.

Development Engineering: A large engineering research program is under way to answer design questions with especial reference to W. Additional space for this work is being developed and additional personnel obtained but few of the pressing problems requiring experimental solution can receive proper attention for several weeks.

In order to predict the performance of gas disposal stacks at W it is planned to initiate experimental studies at X within a few weeks' time.

SUMMARY OF ACTIVITIES OF HEALTH DIVISION (Dr. R. S. Stone)

During the month of March 1943, the Health Division has been occupied with carrying forward experiments started before this month and not yet completed and with procuring space and equipment for further work here and at Site X.

Routine examinations of personnel, both new and old, have continued to occupy a great deal of the time of the clinical staff. It is satisfying to report that no blood changes which could be attributed to radiation effects have been found during the past month. The clinical staff has also been interested in following the effects of total body irradiation, administered in the course of treatment of disease to some patients at the Chicago Tumor Institute. The clinical and physical divisions have cooperated in continued measuring of the actual exposures of personnel in different parts of the Chicago project. Some difficulties in keeping down the over-exposure of localized areas of the body, such as the hands, are being overcome as a result of such measurements.

Dr. Tannenbaum has continued his work on the toxicity of metal x (plutonium) in various forms and has so far proved that it is not likely to enter the body in any quantity via the two most likely portals, namely through the digestive tract or through the skin. The clinical and physical divisions have cooperated in devising an ionization chamber for measuring the radiations from very small quantities of the metal.

The biological experimental division under Dr. Cole has continued work previously begun on a comparison of effects of fast neutrons and x-rays on rabbits. They have been concerned with blood and lethal effects. Dr. Zirkle has kept going his colony of drosophila so as to have this available for biological calibration of physical instruments. Owing to a lack of availability of Xe^{127} the experiments with noble gases have not proceeded very far. However, the development of apparatus for this purpose has made satisfactory progress and preparations are under way for the use of Ar^{41} as a substitute for Xe^{127} .

4/1/43

It is satisfying to report that the animals which we kept in the West Stands near the experimental pile are still alive and well and show no ill effects from having been exposed to more radiation from the pile than were any of the personnel.

The physical division has made many calculations of probable radiation hazards such as the toleration limit of pollution of water with materials from a pile so that they will not be dangerous for men or fish, whether swimming in or drinking the water.

A survey of protective instruments has been undertaken in conjunction with a "Monitoring Committee." A Lauritsen electroscope has been modified to work more satisfactorily in survey work both around the Chicago project and elsewhere, and an alpha counting chamber for measuring micro-quantities of the metal has been devised so that it can be used either for samples of air from plants or laboratories handling the metal, or for the ashed tissue of human or animal origin. The development of a pocket electroscope that will function well in humid weather is progressing. The physicists have supervised the procurement of several radium sources.

There have been no reports from the projects at the University of California, the National Cancer Institute, or the Memorial Hospital, but all of these are continuing their respective investigations and will have reports in the very near future.

The planning of buildings, space and equipment for Site X, and the necessary outlining of experiments to be performed have taken a large part of the time of all sections of the Health Division.

SUMMARY OF ACTIVITIES OF THE CHEMICAL DIVISION (J. Franck)

This section is identical with the material sent by Franck to Compton last Friday.

SUMMARY OF SITE X DEVELOPMENTS (M. D. Whitaker)

Organization: A tentative organization has been drawn up for the work at Site X. This organization divides the personnel into two groups: (1) Plant Operations Group, and (2) Research and Development Group. These groups are subdivided for administrative purposes. Some progress is being made in selecting and assigning personnel to various positions in the organization.

4/1/43

Design for 100-Area (105): The design work on the pile and pile building is proceeding satisfactorily. Preliminary prints have already been discussed with various interested people in Chicago. The shield problem is not yet completely solved, but we hope it will be in the next few days.

Design for Separation Plant (205): This work is well along in spite of the fact that a new cell (no. 6) was added recently. This cell is to be used for other processes than the wet fluoride one.

Design of other facilities: Design work is in various stages, from completed to beginning, on the following buildings: Materials Testing Building (101), Administration Building (703), Cafeteria (708), Health Building (719), Maintenance Shop (717-a), Research Shop (717-b), Chemistry Laboratory (706), and various service buildings.

Construction: I visited the Site on March 12, 1943, and was disappointed by the small amount of construction work under way. The Materials Testing Building is now promised for April 20, with complete equipment installed by April 30, 1943.

SUMMARY OF ACTIVITIES OF ADMINISTRATIVE OFFICE (R. L. Doan)

Personnel: At the end of March the number of employees of the Metallurgical Laboratory stands at 558, of which 52, including Site X trainees, are from du Pont. About 60 new employees were acquired during the month, of which 15 were from du Pont. Seventeen employees left the project for one reason or another.

As of April 1, 18 employees designated to go to Site Y will be transferred to the Site Y payroll, in accordance with a memorandum received from Dr. Manley. As yet there has been no similar designation for Site X.

Increase in Working Hours for Non-academic Employees: On March 1st the regular working hours for non-academic employees were increased from 40 hours per week to 44 hours per week, with a proportional increase in pay calculated on a straight time basis. On April 1st there will be a further increase to 48 hours per week to bring the laboratory into line with government instructions relative to minimum working hours for contractors working on urgent war jobs in labor shortage areas.

4/1/43

Administrative Officer for Argonne Laboratory: In accordance with a request made by Colonel Marshall, an administrative officer has been obtained for the Argonne Laboratory. He is Mr. J. C. Hobart who comes to us from a position as Regional Director and Chief Administrator of the Food Distribution Administration in Chicago. Mr. Hobart will assume his duties at Argonne about April 1st.

Transfer of Contract from OSRD to Army: Plans have been formulated for a physical inventory for all project property which has been purchased with OSRD funds in order that a suitable accounting may be made to the OSRD, and also that the property may be turned over to the Corps of Engineers. Our property office is cooperating with Major Peterson's office in planning the inventory, and several special officers representing the army will be present when the inventory is made on the weekend of April 3rd and 4th.

New Laboratory Space: Negotiations were completed during the month whereby the Project has acquired the entire use of Eckhart and Ryerson Laboratory buildings, as well as a large building at 61st and University for housing certain special activities. Alteration work is in progress to make this space available at the earliest possible date, and it is anticipated that this move will satisfy such space requirements as are foreseeable at the present time.

Wilma and Al Ghiorso had dinner with Helen and me in our apartment tonight.

Zirkle and Parker talked on biological effects of radiation and medical aspects of the project at the laboratory Research Associates meeting this evening in Rosenwald Auditorium. Research Assistants also attended this meeting in line with the new policy of including them in some of the meetings.

Newspaper reports today say that there is fierce fighting in Tunisia with American troops making advances against stiff army resistance.

Friday, April 2, 1943

J. Leonard Dreher started working as a Research Associate in Section C-I today, coming from the General Petroleum Company in Los Angeles. I knew him as a fellow chemistry major during undergraduate days at UCLA. I intend to have him work on plutonium extraction processes, starting with the Bismuth Phosphate Process, with Thompson in Room 4. Later on he may work on some of the chemical engineering aspects in view of his background and training. Helen met him at 7:30 a.m. when he arrived by train.

Stearns sent me a schedule of lectures for the training program for Site X supervisors which starts April 5. The purpose of the program is to give an overall picture of the total project and not a working knowledge of any particular phase of the work. Scheduled speakers for April are Stearns, Coryell, Wollan, Willard and I. Willard will speak April 5 on nuclear chemistry, and I will continue on the same subject a week later when I return from Berkeley.

Franck has asked for a short history of our Section C-I for use in the preparation of a history of the Met Lab Chemistry Division for Compton. I sent him the following: "The early work on the chemistry of plutonium was carried out in Berkeley and may be thought of as covering the period of December 1940 to April 1942. In December 1940, Seaborg, Wahl and Kennedy bombarded uranium with high energy deuterons in the Berkeley cyclotron and isolated a beta-particle-emitting isotope of element 93 (neptunium). When this substance decayed an alpha-emitting substance, which was identified as an isotope of element 94 (plutonium), was obtained. This 50-year 94 was later identified as 94^{238} and it was with the use of this substance as a tracer that the first investigations on the chemistry of plutonium were made. One of the major earlier developments in plutonium chemistry was the discovery of the 'oxidation-reduction principle' whereby plutonium can be reversibly placed in different oxidation states whose chemical properties differ markedly. It is this principle that forms the basis for several of the extraction and decontamination processes that have been evolved.

4/2/43

"Making use of the chemical properties of plutonium as determined on Pu²³⁸ approximately 1/2 microgram of Pu²³⁹ was isolated, along with about 200 micrograms of LaF₃ carrier, from uranium that had been subjected to a rather lengthy neutron bombardment. In May 1941, Seaborg, Segrè, Kennedy and Lawrence in Berkeley made the first slow neutron fission measurements on Pu²³⁹ using the above mentioned sample.

"Work on the chemistry of plutonium was started in Chicago in April 1942 while work has also been continuing in Berkeley to the present date. This work has been done both on the tracer scale, using the 50-year Pu²³⁸, and on the ultra-micro scale using 'pure' Pu²³⁹. The first 'pure' plutonium was seen in 1942 in Chicago when about one microgram was prepared as the fluoride free of carrier material. Since then about one milligram altogether of Pu²³⁹ has been isolated from several cyclotron bombardments. Using this plutonium and working on the ultra-micro scale, many experiments have been carried out in which plutonium was treated as an ordinary chemical substance. One of the important measurements made upon this Pu²³⁹ was the direct determination of its half-life (21,300 years) by weighing the oxide and the iodate and determining the alpha-activity of such samples. The microchemical work has also been used to determine many of the chemical and physical properties that could not be obtained from tracer experiments.

"A major part of the effort of this group and the Berkeley group has been applied to the development of extraction methods for removing the plutonium from uranium and fission products. Among the processes developed may be listed: (1) wet fluoride, (2) dry fluoride, (3) acetate, (4) peroxide, (5) adsorption, (6) phosphate.

"Besides the work on plutonium a new slow neutron fissionable isotope of uranium, namely, U²³³, was discovered by Seaborg, Gofman and Stoughton in Berkeley in the fall of 1941, and possible means of forming this substance and separating it into a useable form have been worked on in Berkeley and are being worked on now in Chicago."

"Chemical Research—Chemistry of 94, Report for March 16-31, 1943," with the report number CN-556, is being issued. The following items are covered. Ultramicrochemical investigations on plutonium—Cunningham and Werner. Four micrograms of plutonous oxide have been converted to plutonous fluoride by treatment with anhydrous HF at 500°C (fluoride

4/2/43

treatment carried out by Hill) in order to obtain material required for an attempt to prepare plutonium metal. The increase in weight has been measured and found to correspond closely to that required for the reaction $\text{PuO}_2 \longrightarrow \text{PuF}_4$. In order to secure an independent determination of the ion charge of the fluoride insoluble state of plutonium, the oxalate of plutonium has been precipitated and the oxalate content determined by titration. A mole ratio of oxalate to plutonium of 2.17:1 is calculated from the results. The fact that the ratio is higher than 2:1 is believed due to the co-precipitation of potassium oxalate. Tests of the precipitation of oxidized plutonium with sodium hydroxide indicate it is not stable in alkaline solutions. Plutonium fluoride has been found not to precipitate from a solution containing 2 g plutonium per liter in 1 M HNO_3 when made 2M in HF, but precipitation occurs at once when 10 g per liter of KCl is added. An attempt has been made to isolate 93^{237} from the St. Louis bombardment which ended October 25. The object is to secure a quantity of this 3×10^6 -year half-life material for determining its chemical behavior in relatively large concentrations. Only about 600 d/m of alpha activity were isolated which could be ascribed to 93^{237} , whereas it has been calculated that 37,000 d/m could be expected. No explanation for the low yield can be found.

Volatility methods for separating plutonium--Brown, Hill and Bohlmann. When a bismuth phosphate precipitate containing plutonium is treated with HF at 500°C and then with fluorine at any temperature above 300°C , the bismuth and plutonium are completely volatilized. Both volatile species may be quantitatively condensed in a trap at 100°C . This is a phenomenon difficult to understand on the basis of previous work and may indicate that the plutonium is forming a pentafluoride and the BiF_5 is acting as a carrier. A dry fluoride cycle has been studied for the decontamination of bismuth phosphate precipitates from the bismuth phosphate extraction method. Each dry fluoride cycle appears capable of decontaminating by a factor of 50. This produces an overall decontamination of 500 for the extraction step plus one fluoride cycle, or of 25,000 for the extraction step plus two dry fluoride cycles.

Wet Fluoride Method for separating plutonium--Knox. A series of tests shows that the amount of uranium which is carried by lanthanum fluoride when precipitated from uranyl nitrate solutions depends upon the amount of

4/2/43

lanthanum precipitated but is relatively independent of the uranium concentration, a result which is significant in determining the correction to be made for uranium alpha radiation when analysis is being made for plutonium by precipitation with lanthanum fluoride carrier. A study has been made of H_2O_2 as a reducing agent for plutonium at room temperature and it is found that the rate of reduction increases with increasing HF and H_2O_2 concentrations.

Adsorption methods for separating plutonium—Turk and Fries. A number of specially prepared titanium oxides and phosphates have been tested and show good ability to adsorb tracer amounts of plutonium, but also adsorb considerable fission activity. The rate of adsorption of plutonium by silica gel from 10% uranyl nitrate solutions apparently is not altered by the presence of aluminum ion in the solution.

Phosphate Method for extraction and decontamination of plutonium—Thompson, Davidson, Miller and James. One oxidation-reduction cycle in addition to the extraction step in the Bismuth Phosphate Process is found to reduce the fission product activity carried with the plutonium to 0.08% of that initially present. A similar degree of decontamination is found when a sodium uranyl acetate decontamination cycle is coupled to a bismuth phosphate extraction step. A satisfactory oxidation procedure has been developed by using 0.1 M $K_2Cr_2O_7$ in a 6 N HNO_3 solution of the bismuth phosphate dissolved after the extraction step ($95^\circ C$ for two hours).

I left Chicago at noon on the Santa Fe Chief for Los Angeles.

As I left, Helen was planning to meet with the Girl Reserve mothers this afternoon, have dinner with the Ghiorso's tonight and with the Perlman's tomorrow night.

Saturday, April 3, 1943

Enroute to Los Angeles.

Sunday, April 4, 1943

I arrived in Los Angeles about two this afternoon and visited my parents in South Gate. I took the opportunity to call my UCLA chemistry schoolmate, Richard E. Lauterbach, who lives in South Gate and works for General Petroleum Corporation, and ask if he might be interested in joining our Section at the Met Lab. He promised to think it over and write me a letter when I return to Chicago. I also talked with Harlan Baumbach and Saul Winstein.

At 9:00 p.m. I caught the "Lark" to San Francisco.

Monday, April 5, 1943

I arrived in Berkeley this morning and registered at the Durant Hotel, where I will be staying until my departure Thursday. My first visit was with Latimer and his group with whom I will be spending most of my time throughout this week.

Later Segrè and I got together for a discussion about our draft patent application concerning production of energy by the application of 94^{239} .

Tuesday, April 6, 1943

Louis Strait came over from the Medical School in San Francisco. We met at the Department of Chemistry and discussed the possibility of his joining the Met Lab in June and the feasibility of his doing some advance preparation in his own facilities before coming to Chicago.

I spent most of the day in discussions with the fellows on the third floor of Gilman Hall. There are many new people on the job and new security arrangements, with guards, are now in effect.

Wednesday, April 7, 1943

This morning I took the jitney up the hill in back of the campus to see what progress is being made with Lawrence's electromagnetic process. When I was last here, January 7, I learned that five "racetracks" of 96 calutrons each will be built at Site X. A few days after my visit, on January 14, General Groves met here with representatives of General Electric, Westinghouse and Stone & Webster and insisted that they have the first racetrack built and ready for operation by July of this year. To them, this demand seemed impossible to meet on time. Subsequently, on February 18, Stone & Webster broke ground for the first of three buildings to house the five racetracks. The electromagnetic plant will be situated in its own valley at Site X (called the Y-12 area), adjacent to the valley where we will have the plutonium pilot plant operation (the X-10 area).

In addition to the five racetracks, a decision was made less than a month ago to build additional racetracks of calutrons to further enrich the U^{235} -enriched product of the first five racetracks. Thus there will be two stages in getting U^{235} of high enough concentration for an atomic bomb: The alpha stage consisting of five racetracks, and the beta stage consisting of two smaller race tracks, each having 36 calutron tanks and 72 sources. It has even been suggested that the beta plant be used to recycle the U^{235} -enriched material from the gaseous diffusion plant to be erected in a third valley at Site X (called the K-25 area). The K-25 plant is being designed by the Kellogg Corporation and will be operated by Carbide and Carbon Chemicals Corporation.

The preparation of feed material for the calutrons at Site X and chemical processing of the separation product will be in the hands of Tennessee Eastman Corporation, a subsidiary of Eastman Kodak. Tennessee Eastman will also be responsible for operation of the entire plant at Y-12. It has now established an office in Berkeley for the training of key operating personnel.

Lawrence's laboratory is a frenzy of activity. The atmosphere here is entirely different from that at the Met Lab, which has a quiet composure but a steady drive under Compton's direction. Research on the electromagnetic process here has not abated, with much effort going into improving the sources and receivers. Also, two calutron alpha units have been set

4/7/43

up in the 184-inch cyclotron building. The calutrons stand twelve feet high and consist of magnet coils encircling vacuum tanks that contain double sources and receivers. Three crews operate them around the clock, just as there are crews to perform experiments on the calutrons associated with the 184-inch cyclotron magnet.

Later today, I had a long discussion with Leo Brewer on possible schemes for making uranium and plutonium metal. He gave me many references and much information on refractories, the thermodynamics of reduction of UO_2 with electropositive metals and the role that UC_2 might play in reduction schemes. Brewer says that the reduction of UO_2 by hydrogen is thermodynamically impossible, but described a number of methods for making uranium metal (and also presumably plutonium metal), including the hot wire method.

Thursday, April 8, 1943

This was my last day at the University. Before I left, I visited Latimer's project once more. Among other matters, Latimer and I had a thorough discussion on the plutonium purification problem; he gave me some good tips on testing for light element impurities, especially fluorine. We also talked about the matter of patents on adsorption methods being studied by the Chicago attorneys.

At 4:30 p.m. I boarded the "City of San Francisco" for my return trip to Chicago.

Friday, April 9, 1943

Enroute to Chicago.

Saturday, April 10, 1943

I arrived in Chicago this morning, and Helen was at the station to meet me. Except for last Tuesday when she was ill, Helen kept busy with the YWCA, the Girl Reserves and the Newcomers Club. She had dinner engagements almost every evening, being invited to the Perlman's, the Howes' and the Ghiorso's. Wednesday she and the Ghiorso's again had dinner together and then went to the Tower Theater and saw a double bill, "Time to Kill" with Lloyd Nolan and "Journey into Fear" with Orson Welles, Dolores Del Rio and Joseph Cotten.

At the Lab, Covey told me that I missed a fascinating meeting of the Research Assistants seminar night before last, when Kirk was the principal speaker. Kirk reported on his trip with Eastman to the eastern United States and gave a description of the historical background for the production of uranium metal and described the possible application of similar methods to the production of plutonium metal.

I greeted a new member of my Section who started work last Wednesday during my absence. Clifford Smith, a Research Associate, is from San Francisco where he worked for Owens-Illinois Pacific Coast Company. He is a friend of Kirk and Cunningham, has some experience in microchemistry, and I plan to have him work with Cunningham in Room 10 in his ultra-microchemical program. This is the third time Smith and I have met; Kirk introduced us in Berkeley early in January, and we met again when he visited us in Chicago in the middle of March.

I also learned from Miss Smith that our new secretary, Virginia Crawley, left us last Tuesday. However, a new girl, Mary Jane Tharpe, has joined our secretarial staff. She, like Annis Moore, is the wife of an Air Force meteorological student at the University and joins Miss Smith and Mrs. Moore in Room 14.

Harrison Brown took a trip to Baltimore and Wilmington last Sunday and returned on Wednesday. He gave me a run-down on the results of his visits

4/10/43

to his former school, Johns Hopkins University, and with the du Pont people in Wilmington.

Three meetings of interest to me were held during the week, the Chemical Engineering Section meeting, the regular Adsorption Processes meeting, and the Laboratory Council Policy Meeting.

The Chemical Engineering Section meeting was held on Monday. Those present were W. Q. Smith, Apple, Lane, Peery, M. D. Peterson, Rodger, Vincent and Webster. It was noted that the semiworks operation has been delayed by leaks in the centrifuge bowl. The results of semiworks runs C-4 and C-5 were reported. These were wet fluoride runs, testing arsenious oxide as reducing agent in the extraction cycle, and using silver peroxydisulfate as oxidizing agent and hydrogen peroxide as reducing agent in the decontamination cycle. The operating manual for the semiworks bismuth phosphate runs has been prepared. These runs also will be carried through an extraction and one decontamination step. The first one started that evening. Two bismuth phosphate runs will be made with the same 5% active-95% inactive salt mixtures used for the previous wet fluoride runs. Three runs are then scheduled using 50% active and 50% inactive salt, one each: bismuth phosphate, wet fluoride with peroxide reduction, and wet fluoride with arsenious oxide reduction. There is not enough active UNH on hand for these high-activity runs, but sufficient neutron-bombarded uranium oxide is available, which will be dissolved in nitric acid to make an active salt solution. Methods of solution of the oxide in nitric acid that would avoid too violent reaction, and that would leave only a slight excess of acid in the final solution, were discussed. It was planned to carry out this solution step Wednesday on the day shift.

The Chemical Engineering Section plans to extract 50 pounds of the hottest UNH from the next St. Louis sample with ether for people in our chemistry section, as their chemical laboratory in the Service Building (where the cyclotron is also located) is the only feasible location for this operation. The group will cogitate on methods, equipment and safety precautions to be used.

4/10/43

The meeting on adsorption methods for 94 separation was held in Franck's office at 2:00 p.m. on Tuesday, attended by Adamson, Beaton, Boyd, Cooper, Franck, Miles, Maloney, Olson, J. H. Peterson, Russell, Smith, Sutton, Swartout and Willard. Adamson, Russell, Willard and Sutton reported on the progress during the preceding week on the adsorption processes for the separation of 94 from uranium and fission products. Adamson's report on the standard conditions for batch testing of adsorbents was discussed. Using this procedure, Adamson agreed to investigate the effect of temperature and pH on the rate of adsorption of 94 on IR-1 resin and on the saturation point. Boyd reported that he expects his group to have data available for the next meeting on the tests set up at the previous meeting on the effect of column height on the adsorption of 94 on IR-1 resin. It was decided that future meetings will be held at two-week intervals. The next is scheduled for 2:00 p.m. on Tuesday, April 20th, in Franck's office.

The Laboratory Council Policy Meeting took place at 10:00 a.m. on Wednesday in Room 209, Eckhart Hall, and was attended by Allison, Cooper, Doan, Fermi, Franck, Greenewalt, Hilberry, Miles and Stone. Topics discussed included a rating scheme for technical people, plans for research on pile shielding and disposition of the depleted material resulting from the U^{235} isotope separation project—tons will be available in about a year as hexafluoride.

On Wednesday (April 7) Compton wrote a memorandum to Major A. V. Peterson reviewing the status of the various contracts sponsored by the Metallurgical Laboratory. This is what he had to say about the chemistry contract at Berkeley: "University of California, Berkeley, California - OEmSr No. 651 - The work under this contract is concerned with the development of certain alternative methods for separation, decontamination, and reduction to the metallic form of final products. This work has also been carried on under direct supervision of the Laboratory Council at Chicago and has supplemented the work done by Seaborg's section of the chemistry division. At the present time Oppenheimer's group has taken over a considerable number of the personnel and this tends to limit the usefulness of the group somewhat. We are considering seriously the matter

4/10/43.

of transferring the remnants to Chicago if this can be arranged at California. The prospects seem fairly good with the exception of Professor Olson who is one of their strongest men but who is also involved with University responsibilities which appear to make his transfer extremely difficult. We will present a recommendation on this transfer at the earliest possible moment, but in the meantime the work there should be continued since the program is producing results of considerable importance in connection with the final stages of decontamination and with the purification processes."

On my desk was a copy of a two-page memorandum that Franck sent to Compton yesterday. It was entitled, "Historical Resumé of the Research Activity of the Chemistry Division from April 1942 to Date," incorporated part of the material I sent him Friday of last week, and read as follows:

"Section - G. E. Boyd (Analysis). The first task assigned to this section was to obtain uranium of a high degree of purity. That was accomplished by the use of the ether method of extraction, now used on a commercial scale. Another method tried out was the use of adsorption for purification of uranium; that work resulted in the development of an adsorption method for separation and decontamination of plutonium. The main job of this section was to set up an analytical organization which would carry out research and control on essential materials. In this connection, new methods have been perfected for the determination of micro amounts of Ca, Cl, Co, Cr, Cu, Fe, Mg, Mn, Mo, Na, Ni, Pb, Ti and Zn in uranium metal and its compounds. Control analyses and analyses of special materials of interest to the project have been requested in ever increasing number. The actual number of samples analyzed has increased from practically none in April 1942 to a present total of about 600 samples per month.

"Section - Milton Burton (Radiochemistry). Work on chemical changes of material under the influence of radiation started May 18, 1942. Many observations of that type are described in the literature, but no theory adequate to serve us as a guiding principle was available, and furthermore the radiation sources in our Project are complex and much more powerful than the ones previously used. It, therefore, became necessary to use cyclotrons (Chicago and St. Louis) as sources of positive rays and neutrons; Van de Graaff generators (Notre Dame and Massachusetts Institute

4/10/43

of Technology) and the Illinois betatron to produce electron beams and gammas, and an instrument of the Chicago Tumor Institute for X-rays.

"The list of chemical substances, solutions, mixtures and structural materials being studied under bombardments with beta, gamma, and X-rays and deuterons is too long to include in this report. However, it may be pointed out that the work of this section has done much to clarify the effects of radiation of different sorts on water, on corrosion by water, and on a variety of hydrocarbons as well as to permit a reasonable prediction of effects which may be anticipated in cases where no work has been done. The influence of neutron bombardment is, for the most part, studied indirectly, with the exception of some measurements on graphite irradiated in St. Louis. Measurements on the effect of neutrons and of fission recoils are planned at the Site X pile to supplement the work now under way.

"Section - C. D. Coryell (Work on Fission Products). In May 1942 about 64 fission products in 30 chains were known from various literature work dating from January 1939. The number of known fission products is now 110 in 43 chains. Fission yields have been determined for 24 of these chains. Our picture of the long-lived fission products of importance in the separation plant is nearly complete. Reliable beta and gamma energies have been determined for all major fission products of half-life greater than 1 day; from these data energy dissipation in any chemical operations can be predicted. Studies have been made of radioactivity accumulating in coolants, with considerable attention to problems of a He or air-cooled pile. In addition, studies are in progress on the gross beta and gamma activity and energies of very short-lived fission products.

"Section - G. T. Seaborg (Separation, Decontamination and Purification of Plutonium). The early work on the chemistry of plutonium was carried out in Berkeley. The most important discovery (used later in Chicago for separation work) was the oxidation-reduction principle, whereby plutonium can be reversibly placed in different oxidation states whose chemical properties differ markedly.

"Work in Chicago on plutonium started in April 1942, while work has also been continuing in Berkeley to the present date. This work has been done both on the tracer scale, using the 50-year Pu^{238} , and on the ultra-microscale using 'pure' Pu^{239} . The first 'pure' plutonium was seen in

4/10/43

August 1942 in Chicago when about one microgram was prepared as the fluoride free of carrier material. Since then about one milligram altogether of Pu^{239} has been isolated from several cyclotron bombardments. Using this plutonium and work on the ultramicroscale, many experiments have been carried out in which plutonium was treated as an ordinary chemical substance. One of the important measurements made upon this Pu^{239} was the direct determination of its half-life (21,300 years) by weighing the oxide and the iodate and determining the alpha-activity of such samples. The microchemical method has also been employed to determine many of the chemical and physical properties that could not be obtained from tracer experiments.

"A major part of the effort of this group has been applied to the development of extraction methods for removing the plutonium from uranium and fission products. Among the processes developed may be listed: (1) wet fluoride, (2) dry fluoride, (3) peroxide, (4) phosphate, and (5) contributions to the adsorption methods. (The acetate process was developed by the Berkeley group.)

"Besides the work on plutonium, a new slow neutron fissionable isotope of uranium, namely, U^{233} (discovered by Seaborg, Gofman and Stoughton in Berkeley in the fall of 1941) was studied by this Section and by the Berkeley group; possible means of forming this substance and separating it into a usable form have been investigated."

Covey told me the Army representatives were busy last weekend going over our property inventory.

On Thursday Charles Cooper sent a memo to Whitaker describing his proposed organization for the Chemical Engineering Section at Clinton Engineering Works. He suggests the following: W. Q. Smith, Section Chief, R. S. Apple, Assistant Section Chief; L. C. Peery, Group Leader; M. D. Peterson, Group Leader.

The long-planned-for reunion of UCLA chemists, initiated by Pete Heussenstamm of Madison, Wisconsin, last February, took place tonight. It started with a dinner at the Bismarck Hotel. Helen went with me, and the

4/10/43

Thompsons, Coopers, Perlman and Dreher were there. Jarrett also attended, as well as the Coryells and Engelkemeier, Brady and Campbell from his Section. A number of UCLA chemists now working at Northwestern University, including Professor Francis Blacet, also were there. I am glad I returned from California on time.

On the African war front Rommel is speeding his retreat from Tunisia at last and is evacuating some of his key officers and technicians to Sicily.

Sunday, April 11, 1943

I held a meeting of the Council of my section in my office at 10:30 a.m. Present were Perlman, Willard, Kirk, Cunningham, Brown, Orlemann, English and Thompson. I reported on my trip to Berkeley, mentioning that Strait will come for a visit in the near future and will probably be here in July permanently and that Brewer and Olson have suggested three schemes for making uranium (and presumably plutonium) metal: React the oxide with carbon and hydrogen at 1,500°C; react the oxide with an electropositive metal; or use the hot wire technique. We then discussed the following topics.

Extraction methods. Adsorption--Beaton will calculate the efficiency of columns of different shapes and sizes. Phosphate method--Tests on W concentrations of fission products show that barium sulfate does not precipitate whereas zirconium phosphate probably does so. Tests on whether or not plutonium phosphate will dissolve in acid solution are to be carried out on the microscale. Concentration methods--Attention must be given very soon to the concentration and isolation of the plutonium from the plants at X and W.

Purification work. Besides the precipitation of plutonium peroxide, plutonium iodate will also be tried as a means of separating light element impurities. The molecular distillation work that has been started shows promise of working.

St. Louis irradiation. The problem of working up the uranium metal irradiated with neutrons at the St. Louis cyclotron was discussed; the

4/11/43

chemical engineers can probably use up a considerable amount of metal in their semiworks runs either here or at Site X, depending on their moving date. In that case we would concentrate on processing the UNH using our usual ether extraction method.

I went directly home after the Council meeting and was pleased to find Harlan and Nathalie Baumbach there. They have just arrived from Los Angeles. Harlan will start in my Section tomorrow, and Nathalie, who is a chemist, will start in a week or so after they are settled. Helen prepared lunch for all of us. Later in the day, Frances Chilson came for a visit.

Monday, April 12, 1943

The Baumbachs had breakfast with Helen and me in our apartment, and then Harlan accompanied me to the Met Lab, where I started him on his security and employment procedures. He will have the rank of Research Associate and will work with Kirk in Room 13 on our plutonium metal production program.

From 9:45 to 10:45 a.m. in Room 102 of Kent Chemical Laboratory I lectured on nuclear chemistry and radiochemistry, with applications to the tracer chemistry of plutonium to the du Pont supervisors who are being trained for the operation of the facilities at Site X. My lecture dealt with the methods of radiochemistry and continued where Willard left off in his lecture last Monday.

Back at the New Chemistry Building I learned that Kirk and Rosenfels made another attempt on Friday to reduce PuF_4 with sodium. They started with about 16 micrograms of the PuF_4 prepared by Cunningham and Brown by the hydrofluorination of the oxide. This was divided among five glass tubes in the last of which they placed the platinum boat in which the hydrofluorination was carried out (and which contained remnants of PuF_4). The products of the treatment with sodium vapor were found to be distinctly harder and more flaky than the material produced on March 20 and more like

4/12/43

the material produced on March 26. Again it is not clear that this represents the production of plutonium metal.

Last week Knox made a test of the Wet Fluoride Process using neutron-irradiated UNH which was 60 days old. He used the modification of the process in which the lanthanum fluoride precipitates are dissolved by the zirconium method. He found that two cycles reduced the fission product gamma activity by a factor of 14,000 and three cycles reduced the fission product beta activity by a factor of 630,000 and gave a 90% recovery of plutonium.

In experiments last week Fries showed that the percent adsorption of plutonium on silica gel in batch tests with two hours or less contact time is greater in the region of room temperature than at either higher or lower temperatures; the percent of fission activity adsorbed in such tests falls off below room temperature but does not decrease with increasing temperature. These facts suggest the possibility of using two silica gel columns in series, one at approximately 95°C and one at approximately 25°C to decontaminate plutonium solutions.

Stoughton told me that last Wednesday he made lead absorption measurements on the gamma rays from the 27.4-day beta-emitting Pa²³³ using different Geiger counters and slightly differing set-ups, each designed to avoid the contributions of bremsstrahlung. He found by analysis of the absorption curves the presence of two gamma rays of 0.4 and 1.5 Mev, respectively. Judging from their intensity and the known large number of conversion electrons, he estimates that in Pa²³³ there are probably two gamma ray transitions per beta particle and about one-half gamma ray per beta particle emerges without internal conversion.

Miller completed today three complete oxidation-reduction cycles with the Bismuth Phosphate Process in order to determine the overall yield of plutonium and the overall decontamination from fission products. He used 1,000 grams of neutron-bombarded UNH (from St. Louis bombardment Chicago III completed January 23) in order to have sufficient fission product radioactivity. The precipitation of bismuth phosphate was made in the

4/12/43

usual manner from the initial solution and in the subsequent oxidation-reduction cycles, the oxidation was performed by dichromate ion in 6 M HNO_3 and the reduction by SO_2 . After the initial precipitation the amount of Bi^{+3} was reduced to 0.8 mg per cc in order to reduce the volume, thus making it possible to reduce the volume by a factor of 3 in each of the second and third oxidation-reduction cycles. Carriers for fission products were added in order to help the removal of the fission product activity in the procedure. He found an overall yield of 85% of plutonium and a decontamination factor from fission product beta radioactivity of 0.7×10^7 ; the level of fission product gamma ray radioactivity, of course, was much too small to measure in the final sample. These results indicate that the Bismuth Phosphate Process has the capacity to decontaminate plutonium from fission product activity by the required factor of 10^7 .

The du Pont people have decided that we should reduce our effort on the Dry Fluoride Process. They feel that the problems of controlling the temperature to the degree required, the difficulties in collecting the plutonium, and the corrosive nature of the process make it appear relatively unattractive compared with the other processes.

Arthur C. Bond, an outstanding chemist from Schlesinger's uranium chemistry group at the University of Chicago, who has been working on the volatile uranium borohydrides, has started to work with us as a Research Associate in our Section C-I. I am asking him to start his work with Katz and make his headquarters in Room 2.

Hamilton is visiting the Met Lab. We had a discussion about the target plates and probes Creutz is preparing for use for the deuteron bombardment of uranium in the Berkeley cyclotron. We decided to ask Creutz to also prepare some target plates and probes containing thorium, using target and probe mounts which Hamilton will send him.

Harrison Brown sent a memo to Libby at Columbia giving estimates of radiation intensities from a pile fueled with liquid UF_6 .

4/12/43

English and Willard wrote to Whitaker regarding control analyses at Sites X and W. As an aid to plans being made for routine control analysis in the extraction and decontamination processes, they made estimates of the size samples for each analysis, methods of analysis, accuracy of analysis and points in the procedures at which analysis is necessary.

Perlman replied to a letter written by H. W. Newson April 6 regarding the method of containment for the thorium salts to be irradiated in the pile at Site X. He said that Newson's suggestion that the thorium salts be placed in 1-inch x 4-inch aluminum capsules will be satisfactory.

There was a Chemical Engineering Section meeting today attended by W. Q. Smith, Lane, Peery, M. D. Peterson, Vincent and Webster. Completed and planned semiworks runs were discussed. Runs C-6 and C-7, each with an extraction step and one bismuth phosphate decontamination cycle, have given erratic results due to analytical problems. Run C-8, a Wet Fluoride Process run in which the lanthanum fluoride is dissolved with the help of metathesis with NaOH, is still under way. Run C-9 is planned to be a wet fluoride run with reduction by hydrogen peroxide in the extraction step and by SO₂ in the decontamination cycle, run C-10 the same as run C-9 but with a high concentration of active UNH, run C-11 the same as run C-10 but with arsenite reducing agent in the extraction step, and run C-12 a bismuth phosphate run.

The fourth large neutron bombardment of UNH at St. Louis (Chicago IV, started February 9) ended tonight at a total of 200,000 microampere-hours.

Helen had lunch with Nathalie Baumbach. In the evening Helen and I ate with Joe Hamilton at Ray's (a steak house) on East Illinois Street, and then we all went to a show.

From two fronts the war news is good today. There was a furious air battle over Oro Bay, New Guinea on Sunday with 23 Japanese planes shot down. The Tunisian battle shows Allied forces moving at 20 miles a day.

Tuesday, April 13, 1943

Koshland, working with Al Clifford and Donald Shepard of the Technical Division, has tested the oxidation of plutonium in high concentrations of UNH since it is advantageous to oxidize the plutonium in as concentrated a solution as possible in the first step of the Wet Fluoride Method. They carried out oxidation at 80°C with 0.1 N dichromate ion. They find at 31% UNH and 1.3 N HNO₃ complete oxidation in one hour and at 42% UNH and 2 N HNO₃ complete oxidation in three hours.

Last week Davidson conducted experiments on the Bismuth Phosphate Process in which he added concentrations of barium and zirconium such as will be produced with the plutonium at Site W. His experiments indicate that at these concentrations zirconium phosphate may be expected to precipitate in the bismuth phosphate extraction step but that barium sulfate will not precipitate. The amount of zirconium phosphate probably will not be enough to interfere chemically or mechanically with the process.

James today completed a test of a "reverse" Bismuth Phosphate Process in which the first bismuth phosphate precipitation from the UNH solution is brought down after oxidizing the plutonium so as to leave it in solution. This modified procedure would be useful if high concentrations of fission products at Site W should interfere with the present standard bismuth phosphate process. In the procedure in which the bismuth phosphate is first precipitated, together with zirconium phosphate and barium sulfate, from an oxidized solution, using dichromate ion as oxidizing agent, followed by the co-precipitation of the reduced plutonium with bismuth phosphate after reduction with SO₂ and then reprecipitation of the bismuth phosphate, James finds a yield of 87% plutonium and the reduction of the fission product beta activity to 0.7% and of the fission product gamma activity to 0.8% of that originally present.

As a follow-up to my talk with Hamilton yesterday, I sent a letter to Creutz asking if he would prepare some target plates and probes containing thorium for use in bombardments in the Berkeley cyclotron.

4/13/43

At the meeting of Section C-I Extraction Group Research Associates held in my office this evening, I reviewed the status of bombardments at St. Louis, the status of plans for Sites X and W as they affect our Section, and the properties and potential for use of U^{233} .

Helen went to the Metro Y volunteer lunch today. Wilma spent the evening with her while Al and I were at the Extraction Group meeting.

Today's paper reports that the Japanese have flung 100 planes at Port Moresby (main Allied base in New Guinea) and 37 were shot down. The Axis forces, meanwhile, have been pressed into one corner of Tunisia.

Wednesday, April 14, 1943

Alexander Langsdorf had breakfast with Helen and me this morning. This gave us an opportunity to discuss in detail his experiment on 93^{239} radiations.

Paul A. Schulze started to work in Section C-I today as a Research Assistant, coming from the University of Chicago where he has been working on the OSRD uranium project directed by Professor Schlesinger. I plan to have him work on the U^{233} problem in Room 2 as soon as I can get a group under Stoughton started on this.

General Groves is in Chicago today.

I sent a memorandum to Franck designating Stan Thompson as leader of the group on wet methods of extraction because of his already considerable responsibility for the direction of the work; I had been reserving this position for Friedlander, whom we have not been able to obtain. I also told Franck I am interchanging two men: Knox is being transferred from Perlman's purification group to extraction work, which is under the overall direction of Willard; and Joe Katz is being transferred from the extraction group to the purification group.

4/14/43

Covey made preparations for the next large St. Louis shipment and cyclotron bombardment, this time a mixture of UNH, uranium oxide and metal which should increase the yield of Pu²³⁹. He spent all afternoon loading the truck, which involved arranging 82 bricks (a ton) of lead shielding, weighing and loading the UNH, oxide and metal in special tinned and coated boxes, plus some target material for Coryell. He then made final arrangements for the driver and told him how to proceed to St. Louis. On his return trip the driver will bring back the Chicago IV sample.

Today John Willard and I signed patent papers in connection with case no. S-59 entitled "Adsorption Process for Separation of Materials."

Theodore Magel left for Ames, Iowa, by train at 5:00 p.m. to study metal production at the Ames Laboratory. He and Dallas have been searching for a "solvent" for plutonium which will dissolve the metal but not the oxide, thus making it possible to purify the metal from the oxide. A possibility is mercury and they have done stand-in experiments with metallic uranium in which they find uranium dissolves in mercury to the extent of about 0.1% at 75°C and at 162°C—a value considerably higher than that previously reported in the literature. This indicates that this method for oxygen removal might be feasible but this is probably doubtful. They have also investigated the production of uranium nitride for possible use as a crucible material in the production of plutonium metal because of the high concentration of nitrogen impurity that can be tolerated in the final plutonium metal. They have synthesized uranium nitride from N₂ and UH₄ at 660°C. When this was dried in an oven at 150°C, it caught fire showing that crucibles prepared from the nitride would have to be heated in the absence of air and moisture.

We held the regular Wednesday evening meeting of the Purification and Metal Production Groups in my office. We reviewed the fluoride volatility and precipitation (peroxide and iodate) methods of purifying 94 and the salient points of the metal production program. In the metal production program the problem is enhanced by the electropositive nature of 94 and the burden this places on the refractories. Perlman emphasized again, in connection with the purification requirements, that the tolerable neutron

4/14/43

emission rate is equal to or less than 7,000 neutrons per minute per kilogram of 94^{239} and that one kilogram of PuO_2 gives 7×10^6 neutrons per minute and of PuF_4 1×10^9 neutrons per minute (a dangerous quantity for human beings). The tolerance limits set for any one impurity corresponds to 3,000 neutrons per minute per kilogram of 94. English pointed out that with the presently available neutron detection technique (a BF_3 counter) about 30 grams would be needed to establish the required purity, an impractical amount. Cunningham described his program of 94 purification based on molecular distillation of relatively volatile 94 compounds.

Nathalie Baumbach and Wilma Ghiorso had lunch with Helen and spent the afternoon with her.

There was a Laboratory Council Policy Meeting at 10:00 a.m. in 209, Eckhart Hall, attended by Compton, Cooper, Doan, Fermi, Franck, Hilberry, Marshall, Miles, Spedding, Stone, Whitaker and Wigner. Later, Groves dropped in.

Compton opened the meeting by giving three scheduled completion dates at Site X: Graphite Building, May 15; Pile Building, July 15; and pile construction, August 15. Plans for living quarters for Site X people, he said, will arrive in Chicago in a few days. He expressed the belief that within a year or two Site X will be an excellent place for doing research. As for the Argonne pile, it is practically ready, with the shielding being completed next week. He is concerned about the transfer of Met lab men to Oppenheimer's laboratory in New Mexico, saying it will leave us the weakest in physics support. The names of several theoretical physicists and physical chemists around the country were then suggested by Fermi, Franck, Wigner and Whitaker as possible replacements, including Joseph and Maria Mayer. Compton said that Henry D. Smyth will arrive here about April 28 to spend three-fourths time for the summer.

The next topic concerned the coordination at Chicago of the work on the production and use of a heavy-water pile. Compton thought this might involve bringing some of the Columbia personnel to Chicago and he offered a possible organization scheme: The D_2O pile under Urey,

4/14/43

the graphite pile under Allison and future developments under Smyth. Contracts are now being worked on and the change from OSRD to U.S. Army should not appreciably change the research arrangements. The discussion then turned to more general matters. Compton mentioned the news item that a heavy-water production facility in Norway under German control was destroyed by a British commando raid last month. He said that the importance of heavy water is now out in the open and that sabotage against our work is probable. The reason for the raid, of course, is that the British fear the Germans might know about 94 and would be, or were, producing it in a D_2O -moderated pile.

Doan brought up the matter of vacations and suggested that all Met Lab personnel take a two-week vacation at one time. Compton replied that the G. E. Lamp Research Division does just that, but he didn't see how we could manage. Groves pointed out that the Army allows civilian employees to take seven days a year for vacation, but it is very restricted; in fact, Army officers have no vacations. He suggested that if vacations are taken at all, they should be made part of a long weekend at several times. But there will be no shutdown. Stone spoke up and said that people are working very long hours; Groves retorted that he is not really interested in the next year or two, but is intensely interested in the next few months. It was finally decided that those concerned with Site X should take a vacation, if practicable, before Site X starts up, whereas those not concerned should delay their vacations until late in the year.

Doan next raised the subject of purity requirements for uranium metal and gave some suggestions, accompanied by calculations and a table, how impure metal might be used on the outside of a pile. Stone next spoke on tolerance exposures and said that although the international safety standard is 0.2 roentgen per day, the Health Division is agreeing to allow 0.1 roentgen per day without regard to rate of exposure.

The Council discussed the manufacture of radioactive tracers. It was noted that large quantities of tracers of interest to research other than ours could be produced without interfering with our program; however, the fact that large quantities are available might give away what is going on. Fermi and Compton agreed that tracers should be

4/14/43

manufactured and then let out only as appears feasible. Groves inquired if such manufacture would be of use to the project. Compton replied that, although this is minor to our interests and should not be allowed to interfere in any way, yet we should keep in mind the need of tracers for other war research. He then went on to say that Oppenheimer is asking for one-quarter to one-half milligram of plutonium in about two months for neutron multiplication experiments. Franck asked that a decision be held up for about one week while further investigation of improved manufacture at St. Louis is gone over. Compton said he is not convinced that Oppenheimer's experiment is as important as our chemical program, and Fermi volunteered to talk it over with Oppenheimer. Franck then stated that Berkeley plans to have about one milligram available for Oppenheimer in about three to four weeks, which concluded the meeting.

Thursday, April 15, 1943

Brown, Jaffey and Kohman left for St. Louis by train last night at midnight, along with Coryell, Elliot, Turkevich and Engelkemeier, to work at the cyclotron to improve uranium setups for our neutron bombardment, especially for the forthcoming Chicago V neutron irradiation of UNH and uranium metal. They will be able to work at the target area, now that the Chicago IV irradiation is finished. Using the material that left for St. Louis by truck yesterday, they will measure the yield of U^{239} at various positions in the setup.

I attended a meeting on problems of control analysis at "X" and "W." Others present were Perlman, English, Willard, Ghiorso, Squires, Peery, Struthers, Greager, W. Q. Smith, Kirk and Cunningham. The purpose of the meeting was to enable the du Pont representatives to obtain the recommendations of my section for setting up laboratories to analyze for plutonium by counting techniques. Sampling, analytic techniques and counting equipment were discussed.

Helen ate lunch at Wilma's today.

4/15/43

I presided over the Research Assistants seminar in my office this evening. Thompson gave a complete description of the present status of the Bismuth Phosphate Method, and then I gave a summary of the requirements of an extraction and decontamination process for operation at Site W, comparing the relative advantages of the Wet Fluoride Process, the Bismuth Phosphate Process, adsorption methods, the Sodium Uranyl Acetate Process, and dry volatility methods.

War news continues from the Pacific and Tunisia. For the third time in less than a week the Japanese launched a massive air raid on our Allied New Guinea base--75 to 100 planes and 30 were shot down. The Axis is being driven out of Africa, and Allied bombers are ripping their bases in Sicily as well as in Tunisia.

Friday, April 16, 1943

We have noticed that when uranium containing plutonium is dissolved in nitric acid some of the plutonium is oxidized. Today James conducted an experiment in which neutron-bombarded uranium containing plutonium was dissolved in concentrated nitric acid, and he established by precipitation with lanthanum fluoride that about 12% of the plutonium is oxidized to the fluoride soluble form. This is a factor that must be taken into account in any process in which plutonium is co-precipitated in the reduced form in the initial step.

To our consternation Patton is finding that bismuth phosphate carries only about 70% of the 94 from uranium-free solutions at a bismuth to 94 ratio of 100; this is bad news if it is true.

Today Nathalie Baumbach started working in Section C-I as a Research Assistant with Cunningham in Room 11. Her most recent employment has been in the Citizens National Bank in Los Angeles, but she is trained as a chemist. I knew her as a fellow chemistry major at UCLA during undergraduate days.

4/16/43

Brown returned from St. Louis this morning; the others are returning tomorrow. They made measurements on the distribution of U^{239} in the UNH and uranium metal to be irradiated with neutrons (Chicago V) at the Washington University cyclotron.

The truck with its load of Chicago IV sample arrived back from St. Louis today, and the material was unloaded in the chemical engineers' area of the Service Building.

I attended a meeting with du Pont personnel to discuss concentration methods for the final product at Site X and Site W and disposal of wastes at Site W. Others present were Perlman, Willard, Davidson, W. Q. Smith, L. Squires and O. H. Greager. Perlman estimated that after two wet fluoride cycles in the concentration step, volumes will be reduced to one gallon or less and allow laboratory manipulations. This "semiworks" scale of operation will be followed by several cycles on a beaker scale, and I emphasized that highly trained personnel will be required for these operations. I also pointed out the need to carry out research work on concentration concurrently with the first few production runs. I estimated that six men would form a suitable crew to isolate the plutonium from each half-ton batch of neutron-irradiated uranium. Since two batches will be worked up in parallel, laboratory space for a dozen men is required. Total space in the building must therefore be 10,000-15,000 sq. ft. in order to accommodate the "semiworks" scale concentration work, the final isolation procedure, the offices, counter rooms and other accessories. Squires said that some consideration is being given to the possibility of solar evaporation at Site W of waste solutions containing uranium. Storage in underground tanks may be necessary until procedures for decontaminating the uranium can be worked out. The estimated waste solution volume at Site W is 12 million gallons per year, assuming no evaporation. Smith outlined plans for "Room D" at Site X where volume reduction will take place on the solutions coming from the chemical extraction plant (Building 205) preparatory to giving the material to our chemists for final isolation of the pure plutonium; "Room D" will have an area 50 feet by 30 feet, a number of centrifuges of different sizes and accessory equipment.

4/16/43

After the meeting, W. Q. Smith and I discussed waste storage problems at Site X. We estimate there will be 600,000 gallons of waste per year, assuming no evaporation.

This was the last day of work with us for Wallace Vogwill, who has served us as Laboratory Helper.

Helen had Wilma over to lunch and then had tea at Alice Thompson's with Mary Cooper. In the evening, Wilma and Al Ghiorso came up to play cards with us, the game of "Hell."

Saturday, April 17, 1943

Harlan Baumbach began experiments today preparatory to undertaking the production of plutonium metal, the assignment that I gave him. He is practicing with experiments to reduce UF_4 with active metals such as the alkali and alkaline earth metals to produce metallic uranium.

Dick Lauterbach wrote that ever since my phone call to him April 4 in South Gate his mind has been going around in circles about my job offer. He said that he is assured that his position with General Petroleum is permanent and that, unless extreme pressure were brought to bear, his boss would not let him have a leave of absence. Because his letter is so representative of the quandary that people are in when they are first asked to come to the Project on faith alone, I will quote part of it:

"In order to throw up this job, I would have to have some idea of what I would be getting into. If I were straining at the leash and anxious to leave the Generous Petroleum, any offer would be acceptable. But I don't feel that way, and I wonder if you could tell me that my job would be something like one of the following:

- to make routine chemical analyses in connection with the development of a new method of exterminating the enemy.

- to sit at a desk and calculate heat transfer coefficients at minus 287 centigrade.

4/17/43

- to carry on original research on a laboratory scale on some phase of the production of the universal solvent.

- to supervise the operation of a pilot plant, interpret data, and devise new methods of producing the said solvent.

"Perhaps you see what I am getting at and what I would like to know. I am not trying to break you down and get at the secret of your work. I just want to know enough to enable me to decide whether to quit my job or not."

Lauterbach then asked some specific questions like, does he have a definite job offer? Is the work largely academic? He added that if he were to rely on his wife Dorothy to make the decision they would be on the way right now.

I learned about the possible availability for work at the Met Lab of French T. Hagemann and Lyle Jensen. They are completing their Ph.D. work at the University of Washington in June, Hagemann in organic chemistry with a minor in physics and Jensen in physical chemistry.

Today was the last day with us for Robert Paulsen, who has been working as a Laboratory Helper.

Helen went downtown with Wilma this afternoon, and tonight Helen and I went to Tivoli Theater on Cottage Grove at 63rd Street with Wilma and Al to see "Shadow of a Doubt," featuring Teresa Wright and Joseph Cotten.

According to newspaper reports the U.S. is making forays against the Japanese positions in the Solomon Islands.

Sunday, April 18, 1943

I held a meeting of the Council of my Section in my office at 10:30 a.m. Attending were Perlman, Willard, Kirk, Cunningham, Brown, Orlemann, English and Thompson. We discussed the following topics: Manpower situation. It was decided to leave the scouting work for extraction processes in Chicago. Work should also be started soon to develop

4/18/43

concentration and isolation processes to be used at Sites X and W, the aim being to obtain plutonium 99 percent pure, decontaminated by a factor of 10^7 and containing less than 0.01 percent of boron, beryllium and lithium.

Extraction Processes: Wet Fluoride Process. Koshland, Clifford (du Pont) and Shepard (du Pont) are spending considerable time testing efficiency and reproducibility of control methods. James has found evidence for partial oxidation of plutonium in the dissolving steps--should be checked. Work planned for the future includes retesting of the effects of radiation, decontamination and high fission product concentrations and carrying through of the entire process on a micro scale.

Extraction Processes: Bismuth Phosphate Process. The high temperature in the oxidation step has been found to produce corrosion. The use of cerium seems to remedy the situation and is receiving more consideration. In the reduction step SO_2 has produced some very peculiar results in the semiworks equipment. It seems that sulfur is formed as well as H_2S , presumably through the action of the iron from the tanks. A search for a new reducing agent is in order. Dreher is trying out some new ideas in decontamination involving the use of multiple precipitations from the oxidized solution and reprecipitating the subsequent product precipitate. Experiments are also planned to study, under Site W concentrations of fission products, the decontamination in the phosphate method. Patton is studying the carrying by bismuth phosphate of high concentrations of plutonium for uranium-free solutions, but the early results do not look too promising.

Adsorption. Fries is carrying out more experiments on the effect of temperature on silica gel adsorption and Cooper is determining the effect of pH. Turk is determining column capacity and the degree of concentration obtained on elution. Zirconium phosphate seems to adsorb well, but difficulty has been experienced in eluting. The possibility of adsorbing plutonium while in the oxidized state was brought up, and it was decided to try such experiments when time permits.

Dry fluoride. Brown pointed out that the dry fluoride process was originally discontinued because of the difficulty in temperature control, collection and corrosion troubles. The original method operated over a range of 35° between the temperature at which the uranium and plutonium volatilized. The concentration of fission products made it seem unlikely

4/18/43

that the temperature could be controlled within this range. Brown pointed out it seems as though one might fluorinate UF_4 directly in the presence of BiF_3 , condensing out the bismuth and plutonium, allowing the UF_6 to pass on through, thus obviating the need for careful temperature control. One of the most corrosive steps in the original dry fluoride process was the hydrogenation to reduce upper oxides of uranium to a lower state before HF treatment. It now seems possible to treat the metal directly with a mixture of steam and HF to get a mixture of oxide and fluoride which can be fluorinated directly.

Purification work. Analytical facilities are being looked into for the determination of the prohibited elements. Boyd's section will probably be able to analyze for sodium, potassium, magnesium, calcium, lithium, beryllium, boron, silicon and phosphorus. No methods are yet available for carrying out the analyses to the limits necessary using as little as a milligram of starting material. Cunningham will make a survey of the literature on microchemical analysis to see if analysis on this scale might be possible. Work is also starting on the vacuum sublimation of uranium halides with an effort being made to test wherever possible the separation from the light elements.

Metal production. The main trouble in obtaining a density determination by a capillary displacement method and other bulk properties of plutonium metal lies in the fact that most preparations come out as a powder. There is a need to develop methods of remelting the preparation, possibly in a quartz tube with a refractory lining. It appears that the type of preparation of metal obtained depends upon the starting particle size of PuF_4 . The particle size will govern the rate of reaction which in turn will determine whether the resulting product will melt from the heat of reaction.

This afternoon Helen and I visited the Museum of Science and Industry with Nathalie and Harlan Baumbach and Wilma and Al Ghiorso. After returning to our apartment we received a phone call from Rudolph and Edith Ericson—Edith is my father's first cousin, and they had a brief stop-over in Chicago between trains. The Ghiorso's and Baumbach's then stayed for supper, followed by an evening of cards—a party for my birthday tomorrow.

Monday, April 19, 1943

It is just a year ago today since I arrived in Chicago to undertake my research program here.

Cunningham today measured the solubility of plutonous phosphate in 0.05 M H_3PO_4 and 0.5 M HNO_3 to be 5.8 mg per liter.

Because the oxidation conditions that have been prescribed for the Bismuth Phosphate Process have been found to introduce some corrosion hazards, Miller has experimented in order to seek better, less corrosive conditions. Today he finds that it is possible to oxidize plutonium quantitatively in 2 N HNO_3 at 75°C (as contrasted with 6 N HNO_3 at 95°C) in the presence of dissolved bismuth phosphate. This is accomplished through the use of 0.002 M Ce^{+4} and 0.02 M dichromate ion and requires two hours of time. The presence of the small amount of Ce^{+4} allows the original solution to be diluted to 2 N HNO_3 without precipitation of bismuth phosphate.

Compton asked C. M. Cooper and M. D. Peterson to visit the Mallinckrodt Chemical Company in St. Louis to investigate an explosion that occurred there while uranium metal was being dissolved. Today I received a copy of Cooper's memo to Compton telling about their Saturday visit to the plant, where they conferred with Mallinckrodt himself, Farr, Winters, Williams, Lacher and Dr. Lamb, who was there as a consultant from Harvard University.

The explosion occurred while dissolving some seven pounds of apparently oil- and solvent-free uranium metal turnings, which nearly filled a twenty-two liter quartz evaporating dish. About two liters of nitric acid had been added and further acid was being poured in when a small incandescent spot was observed and the man backed away. A very rapid reaction apparently took place; and at the end of perhaps three to five seconds, the quartz dish shattered and flying pieces broke windows some distance away. There was evidently considerable concussion because the heater on which the evaporating dish stood was badly damaged. No one was seriously hurt. They also discussed the stability of nitrate solutions and Cooper and Peterson pointed out that the literature references to uranium explosions always

4/19/43

refer not to solutions but to crystals prepared from ether solution or from the associated water phase.

"Chemical Research--U²³³ Production and Extraction, Report for Period Ending April 15, 1943," report number CC-595, by R. W. Stoughton is being issued. The topics discussed are: Energy of Pa²³³ gamma rays--curves for the absorption of Pa²³³ gamma rays in lead have been obtained; analysis of the curves indicates two gamma rays of 0.4 and 1.5 Mev respectively, with probably two gamma rays emitted per beta particle of which about one-half gamma per beta is not internally converted. The number and energies of gamma rays from Pa²³³ is important because in the extraction of U²³³ from irradiated thorium, the greatest radiation hazard will arise from the Pa²³³ intermediate. Separation methods for extraction of U²³³ from thorium-- Summaries are given of methods considered for separation of U²³³ from thorium (wet methods, volatility methods, ether extraction, etc.), separation of Pa²³³ from thorium (MnO₂ extraction, iodate concentration, wet fluoride) and separation of U²³³ from Pa²³³ (ether extraction, wet methods, volatility).

"Chemical Research--Special Chemistry of 94, Report for Month Ending April 15, 1943," with the report number CN and CF-591, is also being issued. The following topics are covered: The reduction of plutonic fluoride. Kirk and Rosenfels have reduced microgram quantities of PuF₄ with redistilled sodium in a distillation train. The product has a metallic luster and dissolves in 6 N HCl with the production of gas bubbles, indicating metal might have been formed. An attempt to reduce PuO₂ by similar means did not produce a metallic-type product.

Preparation of uranium amalgam. Magel and Dallas, using uranium as a stand-in, have studied the possibility of purifying plutonium from plutonium oxide by dissolving the metal in mercury. The concentration of uranium in mercury at saturation has been found to be 0.1 percent, a value considerably higher than previously reported in the literature.

Determination of light element impurities in the final product by neutron counting has been studied by Kohman, English and Ghiorso, who have

4/19/43

found that about 30 grams of plutonium would be needed in order to detect the maximum permissible number of neutrons if the alpha particle source is the plutonium itself. The sensitivity might be significantly increased by the use of an external alpha source.

Possibility of purification of plutonium by "molecular distillation." Cunningham, Jaffey and Smith. Vacuum sublimation of a volatile salt, carried out under conditions such that the distance between the heating and condensing plates is less than the mean free path of the molecules at the operating pressure (so-called "molecular distillation") is particularly suited to work on the microscale. The method might be particularly suited to the purification of plutonium from lithium, sodium, magnesium and calcium since the chlorides of these elements have boiling points several hundred degrees higher than the estimated boiling point of 500-600°C for plutonium chloride. An apparatus for carrying out studies of this type has been constructed and was found capable of subliming 0.5 mg of $U\text{Br}_4$ in one hour at 200°C.

Radiation dosage from purified plutonium compounds. Perlman has calculated the neutron and gamma ray production from plutonium and finds that the danger from the neutron irradiation of handling 1 kg of plutonium is of precautionary importance only in the case of the fluoride. Assuming one gamma ray for 1,000 alpha disintegrations, it is possible that more than 0.1 roentgen would be obtained in eight hours at a distance of one meter from a 10 kg sphere of plutonium metal.

"Chemical Research—Production and Extraction of 94, Report for the Month Ending April 15, 1943," with the report number CN-601, is also being issued. The following topics are covered: Plutonium control analyses at Sites X and W. English has made estimates of the size samples which must be withdrawn from solutions of pile materials during chemical processing by the Wet Fluoride Method at Sites X and W. In order to give 500 Pu alpha disintegrations per minute, the size of the samples are of the order of 10^{-2} cc for Site X solutions and 10^{-4} cc for solutions at Site W.

Bismuth Phosphate Method for extraction and decontamination of plutonium. Thompson, Davidson, Dreher, Miller and James. A bismuth phosphate extraction step and three bismuth phosphate decontamination cycles have been carried out using 1,000 grams of UNH from a 178,000 microampere-hour

St. Louis neutron bombardment which was completed January 23, 1943. The yield of plutonium was 85% and the fission activity was reduced by a factor of 10^7 . The use of holdback and precipitation carriers was only slightly effective. Experiments in which concentrations of barium and zirconium such as would be produced with the plutonium at Site W were used indicate that the amounts probably will not be enough to interfere chemically or mechanically with the process. Two promising oxidation procedures are being studied: addition of a small amount of Fe^{+3} to the solution of bismuth phosphate in HNO_3 apparently complexes the phosphate and permits lowering the acidity which speeds the oxidation by $\text{K}_2\text{Cr}_2\text{O}_7$, even when the temperature is lowered from 95°C to 75°C ; another method consists of adding a small amount of Ce^{+4} to the nitric acid solution of bismuth phosphate, which leads to precipitation of ceric phosphate when acidity is reduced to the 2 N HNO_3 level found desirable for oxidation with dichromate.

Wet Fluoride Method of extraction and decontamination of plutonium.

Kohman, Knox, Shepard, Koshland, Clifford. Studies on the oxidation of plutonium in zirconium solutions show that the plutonium can be satisfactorily oxidized with 0.5 mg/cc of Ag^+ and 0.05 M $\text{S}_2\text{O}_8^{--}$ (a reduction by a factor of two over previous recommendations). Reduction studies show that ferrous ion reduces plutonium rapidly in the zirconium cycle and SO_2 reduces it slowly but completely. A preliminary run on 60-day old irradiated uranyl nitrate solutions where lanthanum fluoride precipitates were dissolved by the zirconium method reduced the gamma ray activity by a factor of 1.4×10^4 in two cycles and the beta particle activity by a factor of 6.3×10^5 in three cycles and gave 90% recovery of plutonium.

Adsorption methods for the extraction and decontamination of plutonium. Beaton, V. R. Cooper, Fries, La Chapelle, Sheft and Turk. Batch tests indicate that the rate of adsorption and equilibrium value for the adsorption of plutonium on silica gel are both greater in a 10% UNH solution which has been raised to pH 4.5 by ammonium acetate than in a similar solution of pH 2.4. A considerable portion of the fission activity continues to be adsorbed from a uranyl nitrate solution by a 2 gram column of silica gel after passage of 1,000 cc at 75°C .

General problems in the chemistry of plutonium. Knox, English, James. Metal dissolving studies show that when neutron-bombarded uranium is

4/19/43

dissolved in nitric acid under plant operating conditions, some of the plutonium appears in an oxidized state.

Berkeley group: Ultramicrochemical investigations. Hamaker and Sheline. Oxidized plutonium was carried (95% or more) by sodium uranyl acetate over a wide range of U:Pu ratios (2.2 to 2×10^7). In similar solution (5.7 M Na^+ ; 0.2 M Ac^-) oxidized plutonium was found to have a solubility of approximately 100 mg Pu/l. Decreasing the sodium ion concentration to 2.0 M increased the solubility to approximately 300 mg Pu/l. (The solubility of sodium uranyl acetate under these latter conditions is approximately 760 mg U/l.) The results indicate that the acetate decontamination procedure can be used at any ratio of U to Pu.

Berkeley group: Other investigations. Connick and E. King have a section on "Oxidation Reactions of Neptunium," L. J. Beaufait a section on "Oxidation of Pu and Np by Bromate in Sulfuric Acid Solutions," H. Crandall a section on "Reduction of Pu and Np by U^{+4} ," Gofman a section on "A Np and Pu Separation for the Sodium Uranyl Acetate Procedure," and O. A. Cook a section on "Electrolysis of Uranium, Neptunium and Plutonium from Aqueous Solution."

Latimer is visiting the Met Lab today; so I took the opportunity to bring him up-to-date on our research program and to discuss with him his Berkeley program.

This afternoon Helen went to the West Side Girl Reserve meeting. Marilyn Howe spent the evening with her while Howe and I were at the regular Chemistry Division Seminar. The program was put on by Burton's Section, with talks by Burton, Warren M. Garrison, Leslie T. McClinton and John P. McBride describing their work on radiation chemistry.

Tuesday, April 20, 1943

Today Hill and Bohlmann, working with Brown, completed the distillation of UF_6 from UF_6 bombarded with neutrons (sample F-6-5, 53,000 microampere-hours) at the St. Louis cyclotron which was then allowed to stand for 50 days. They performed a series of four successive distillations

4/20/43

which separated the UF_6 from 99% of the fission product gamma activity and 99% of the plutonium which were initially associated with UF_6 . They find that there is apparently a volatile fission product constituent which distills with the UF_6 and is still present 50 days after the neutron bombardment.

Baumbach is working on the preparation of small ThO_2 crucibles which might be satisfactory refractory material for the production of plutonium metal.

Cunningham measured the solubility of plutonous phosphate in 1 N HNO_3 as 79 mg per liter.

At 2:00 p.m. I attended a meeting in Franck's office on adsorption processes for 94 separation. Others present besides Franck, were Adamson, Beaton, Boyd, Greager, Ketelle, Maloney, Olson, J. H. Peterson, Russell, Schubert, Smith, Sutton, Swartout and Willard. Sutton's group presented information on their work showing that IR-1 resin cannot be eluted with 2 N HNO_3 plus 0.02 M H_3PO_4 . Adamson also presented similar data. Olson described a run on a column using IR-1 adsorbent which failed after five cycles on active UNH. Gas formation was observed at the bottom, and the flow rate decreased. The resin became hot and was destroyed. It was not possible to flow any water through the column. When the resin was tested at 40°C, bubbling began in 30 minutes and the temperature rose 2°C per minute up to 100°C, leading to the destruction of the resin. This presented a rather dismal picture and has lead the chemical engineering group to be quite pessimistic about the potential use of an organic resin as the adsorbent in an adsorption separation process for plutonium. Willard presented data indicating that silica gel retains its adsorptive properties after treatment with concentrated HNO_3 for long periods. High temperatures favor fission product adsorption and low temperatures plutonium adsorption. The adsorption rate increases with increased pH.

In the evening we held our regular Section C-I meeting of our Extraction Groups. Brown reviewed the status of the Dry Fluoride Volatility Method and Perlman and I summarized the plans for the piles at Site X

4/20/43

and Site W. We pointed out that the pile at Site X will have about 70 tons of uranium metal, will be air-cooled and may be capable of operating at 1,000 kw, while the three piles at Site W will operate at 250,000 kw, will have uranium metal extracted after 100 days of operation and this will be cooled for 60 days before going to the chemical extraction plants.

Allies are bombing an Axis airfield and supply ships in Sardinia as well as in Sicily according to today's newspapers.

Wednesday, April 21, 1943

Cefola finished isolating today about 300 micrograms of Pu^{239} , well purified from fission product beta and gamma activity, from the lanthanum fluoride and bismuth phosphate precipitates he has received from Smith's chemical engineers--this is the result of the procedure he started on March 8. He put the product through a total of six lanthanum fluoride oxidation-reduction cycles and gave the material to English and Ghiorso for measurements.

Louis Strait of the University of California Medical School in San Francisco is visiting my Section to get background information in order to conduct spectrochemical analyses. The emphasis will be on measuring trace quantities of light element impurities in various stand-in substances for purified plutonium, such as uranium, when he joins us in June.

I sent a letter to G. F. Mills of the Chemical Process Company in San Francisco saying that the preliminary tests on his resin samples are negative. I accepted his offer to send me some small samples of his new, insoluble, porous resins containing -SH and -PH₂ groups.

In a meeting in Franck's office the decision about the distribution of the neutron-bombarded UNH from the last St. Louis large neutron Chicago IV, which ended April 12 with 200,000 microampere-hours, was made. The following distribution of the 300 pounds will take place: Sutton, 10%; University of California group, 5%; Boyd, 5%; my section for general

4/21/43

extraction and decontamination studies, 10%; my section and Coryell's section for extraction to recover 93 and fission products, 25%; the medical section, 5%; and the semiworks section, 40%. The concurrent bombardment of a considerable quantity of uranium metal which will presumably furnish material for the chemical engineers to practice on was also discussed.

Following the Laboratory Council Policy Meeting this morning, Cooper wrote a memorandum to Whitaker in which he explains why the semiworks area at Site X, together with counting rooms and other facilities shared with my group there, should be available before the pile starts up. He said this must be so in order that the equipment be thoroughly tested on inert or weak material, new men trained, and all will be in readiness to start work on pile material just as soon as it approximates the concentration of the St. Louis neutron-bombarded nitrate (estimated to require about 100 kw-days of pile operation), which is a desirable concentration for general experimental work. For much the same reason, he added, the Separations Plant should be ready at least as early as the pile, and preferably earlier. He reasons that should it lag the pile in completion, it might well be another month before operation could be established, and in that case the first 50-200 milligrams of product would probably be supplied by the semiworks.

Franck sent a memorandum to Hilberry proposing that Edward Shapiro and Theodore J. Neubert of Burton's Section and Stan Thompson of my Section be promoted from the rank of Research Associate to that of Group Leader. He gave for his reason the increase in personnel because of the demands at Site X.

Tonight we held our meeting of the groups working on plutonium Purification and Metal Production. Present were Willard, Cunningham, Patton, Rosenfels, Katz, Kirk, Kohman, Perlman, Ghiorso, English, Davidson, Smith, Baumbach, Cefola, Magel, Brown, Thompson, Jaffey, Stoughton and Orlemann, and Strait (as a guest). I started a general discussion of gamma-ray emission from 94^{239} . Perlman discussed some work reported in the book by Rutherford, Chadwick and Ellis, leading to a possible conclusion that when alpha particles are stopped in lead one gamma may result per 1,000 alpha

4/21/43

particles. I suggested taking a thin 49 sample to measure the gamma rays through cellophane, lead, copper, aluminum, etc., to determine whether the gamma rays found depend on the material used to stop the alpha particles. This should lead to some conclusion as to whether the gamma rays emitted by 49 are due to alpha particle bremsstrahlung or are directly emitted by the nucleus.

Magel described his preparation of uranium amalgams. The solubility of uranium in mercury was found to be around 0.1%. If plutonium behaves similarly, amalgamation does not look too promising as a method of oxygen removal. As an aid in studying the extraction procedures, he is preparing a "master alloy" of uranium containing the amounts of columbium, zirconium, cerium, etc., to be expected in the pile at Site W. Studies of the solution of this material in HNO_3 will be important in all extraction processes.

Kirk summarized the metal production studies. Reduction of PuF_4 with sodium usually results in a powder or sintered mass unsuited for investigation of physical properties. Sodium also attacks pyrex, SiO_2 and soft glass, although least in the case of soft glass. Hence, potassium, cesium and rubidium are to be tried to decrease the attack on the vessels. He also described a simple density determination to be tried when about five micrograms of plutonium are available as the metal. A small amount of a suitable liquid is to be put in a small uniform capillary under a microscope. The liquid will be pulled over the weighed piece of metal in the capillary and the increase in volume determined.

Baumbach is trying to line small quartz tubes with various refractories such as ThO_2 and ZrO_2 to permit melting the 49 produced by reduction of various salts; ThO_2 appears promising.

Davidson discussed methods of studying the properties and preparation of higher plutonium fluorides. The micro molecular still of Cunningham was recommended. CoF_3 , AgF_2 and PdF_3 were suggested as fluorinating agents and removal of O_2 from F_2 was discussed.

Brown summarized some results which indicate the existence of two higher plutonium fluorides which are produced depending upon the temperature of fluorination of PuF_4 .

4/21/43

Katz discussed materials used in dry HF and F₂ reactions including the simplified version of Brown's copper apparatus which is being tested using gamma (microgram) amounts of uranium with U²³² as a tracer.

Patton briefly discussed fluorescence methods of analysis.

There was a two-page picture story in the Tribune today, disclosing details of our American air bombing raid over Tokyo, Nagoya, Kobe and Osaka a year ago. Bombs were dropped on armament plants, oil refineries, docks and railroad yards. The 16 planes were North American (Billy Mitchell) two-engined bombers. They took off from the aircraft carrier U.S.S. Hornet—the "Shangri La"—which later was lost in the battle of Santa Cruz, October 26, 1942. The raid was led by Major General James H. Doolittle (then a lieutenant colonel), who also trained the men, all volunteers. The planes were launched from the Hornet ten hours before the scheduled launching time when they were 800 miles from the target area, the morning of April 18—the same time Perlman and I were enroute to our new jobs at the Met Lab. Originally it was planned to fly in low over the target after dark, but the Hornet encountered three enemy patrol ships earlier that morning, and it was feared they might send a wireless to Japan. The pilots had instructions to land in specified airfields in China after the raid, but because of depleted gasoline, no one reached his destination. Some of the planes landed in Japanese-occupied territory or in waters off the China coast; all were wrecked except one that landed 40 miles north of Vladivostok in Siberia. Many men bailed out at 6-8,000 feet. Of the 80 men who were on the mission, five are interned in Russia, eight are presumed to be in Japanese hands, two are missing and one was killed. The other 64, including Doolittle, made their way to camps of the Chinese Army and then back to U.S. territory.

There was a Laboratory Council Policy Meeting at 10:00 a.m. in Room 209, Eckhart Hall, attended by Compton, Cooper, Doan, Franck, Hilberry, Miles, Spedding, Stearns, Stone, Whitaker and Wigner. Compton stated that attempts are being made to design the Site W production piles to operate at 250,000 kilowatts without the water going above 70°C, because at 90°C there is severe corrosion. He also announced that some of Urey's group will come to Chicago to help in

4/21/43

the design of the P-9 (heavy water) pile. Whitaker reported on the status of Site X. According to him, the principal design problems are now solved and design is nearly complete. He said that du Pont estimates the pile will be ready for operation September 1 and the entire plant by November 1, although he believes these dates are conservative. Cooper pointed out the chemistry building at Site X must be ready a month before the pile is ready so that equipment can be thoroughly tested on inactive or weak material and new men trained.

Thursday, April 22, 1943

The main part (40 pounds) of our portion of neutron-irradiated UNH from the Chicago IV sample was put through an ether extraction cycle, under the supervision of Jaffey, by Covey and his assistants. They worked in the Chemical Engineers' area of the Service Building because this has the best available fume hood for this purpose.

Leonard I. Katzin wired stating that he will arrive at the Met Lab tomorrow.

Lois Russell, a secretary at the Radiation Laboratory in Berkeley, sent a letter inquiring about the shipment of radioactive material weighing 150 pounds (with lead case) mentioned in a memorandum of shipment from Chicago. When I asked Covey about this, he informed me that the carton had been addressed to Gofman in Berkeley. Covey then phoned Gofman, who said that he had received the shipment and assumed that Hamilton knew about it. Lois is a girl whom Helen hired to help her with her secretarial work in the Radiation Laboratory before she left to join me in Chicago. She sent her greetings to Helen.

The Burtons' son, James, was born today.

I replied to Lauterbach's letter dated April 15, attempting to answer his questions as to the type of work he will be doing if he comes with us. I indicated it will be similar to research work such as is carried on at a

4/22/43

larger university toward the Ph.D. degree, but with a very practical aim to it. With regard to the examples he posed, it comes closest to "original research on a laboratory scale on some phase of the production of the universal solvent." I also suggested pilot plant work as a possibility if he were interested, but that this is going on in a chemical engineering section and not in my section. I also explained that he has a definite offer of a job and that I have the authorization to hire five or ten men within the next month or so, and probably more later on. I suggested that he might like to get the reactions of Harlan, Leonard, Stanley and Vance, fellow UCLA graduates whom he knows and who are working here with me now.

I held an informal meeting in my office with Perlman, English, Ghiorso, Jaffey and Kohman on instrumentation needed in connection with plutonium chemistry. The problems discussed and their assignments were as follows: (1) Preparation of polonium α -ray source (Kohman), (2) Neutron counting (Kohman), (3) Slow-neutron fission chamber (English, Ghiorso), (4) Fast-neutron fission chamber (Ghiorso, English), (5) Alpha-particle range chamber (Jaffey), (6) Low-geometry vacuum chamber (English), (7) Magnetic field alpha counter (Crawford, Ghiorso, English), (8) Beryllium electrode chambers (Ghiorso, English), (9) Conversion of Tibbets' second stage to fit high-resolving first stage (Ghiorso), (10) Freon ionization chamber (English), (11) Circuit to measure grid currents of FP54 tubes (Jaffey), (12) Plans for obtaining a complete new FP54 circuit and ionization chamber for Site X (English, Ghiorso), (13) Drawing of circuits (English), (14) Beta and gamma activity of plutonium (English, Ghiorso), (15) Bremsstrahlung problem (Kohman), (16) Geiger-Müller counter work (Jarrett, Kohman), (17) Coincidence counting (Kohman).

Brown conducted the seminar of Research Assistants in my office this evening. He devoted the time to a complete description of the uranium hexafluoride pile concept and the operational characteristics of such a pile.

Kirk spoke at the regular Project Research Associates meeting, giving a complete description of the evolution of the field of ultramicrochemistry

4/22/43

and of the present status, including the quartz fiber torsion balance that he and his colleagues have developed.

The Russian front has come back into the news with violent fighting in the Caucasus.

Friday, April 23, 1943

Yesterday and the day before English and Ghiorso used Cefola's 300-microgram plutonium sample to measure gamma rays and electrons present in the decay of Pu^{239} . They find one gamma ray per 10,000 alpha particles, measured through 3 grams per cm^2 of lead, and 3.5 electrons per 10,000 alpha particles, measured through an absorber thickness of about 20 mg per cm^2 . If these are due to unseparated fission products, this represents a decontamination factor of about 3×10^8 for gamma rays; the factor may be larger than this if the gamma rays are due, at least in part, to Pu^{239} itself.

Also today Cunningham and Werner started their procedure for the extraction of plutonium from part of our allotment of the last neutron bombarded UNH (Chicago IV) from St. Louis. It was put through an ether extraction yesterday, leading to four pounds in a concentrated water layer containing the Pu^{239} , 93 and fission products. Cunningham and Werner plan to put this through a series of oxidation-reduction cycles in order to isolate both the Pu^{239} and any 93^{237} that might be present.

Patton has continued his experiments to test the carrying of plutonium by bismuth phosphate, in the absence of uranium, at the concentrations of plutonium that will exist in the Site W chemical extraction plant; to our dismay he still finds poor carrying, generally below 80%.

Leonard I. Katzin, who arrived yesterday, started work as a Research Associate in Section C-I today, coming from the University of Rochester School of Medicine, where he has been a research fellow in the Radiology Department. He graduated from UCLA in chemistry, where I knew him as a

4/23/43

fellow chemistry student at the time of my attendance there. I am going to have him work with Stoughton in Room 2 on the U^{233} problem.

In the morning I had a meeting with Kohman and Coryell to discuss the Project Handbook into which Coryell is putting much effort. He is compiling Chapter III, "Nuclear Physics and Chemistry," with assistance from Philip Morrison and me. Coryell stayed on a while after Kohman left, and we discussed our relationship and ways of improving it. He is still unhappy about the Goldschmidt-Perlman report on fission products of last September.

Dreher, Thompson and Willard of Section C-I met with Joseph H. Balthis, Collins and M. F. Acken of the Technical Division for discussion of conditions which should be tested with respect to corrosion in the Bismuth Phosphate Process. The 95°C temperature currently used for the dichromate oxidation gives a corrosion rate of 0.01 inch per month in 25-12 stainless steel, in contrast to the allowable rule of 0.0008 inch per month, which condition is met with dichromate oxidation at 50°C . It was decided to investigate more thoroughly the original dichromate oxidation conditions and also to investigate the recently improved conditions (use of ceric or ferric ion in conjunction with dichromate), as well as the temporarily discarded silver peroxydisulfate method.

Coryell asked Doan to release eight standard uranium metal eggs to Jaffey. They will be split for monitoring and then incorporated as part of a general charge for neutron bombardment at the St. Louis cyclotron.

Helen went apartment hunting with Mary Cooper and Wilma Ghorso to help Mary find a suitable apartment for Vance and herself.

Saturday, April 24, 1943

Since aluminum will probably be used to coat the uranium billets in the operating piles, we have been carrying on experiments to test the effect of aluminum on the wet fluoride method. For example, James has

4/24/43

found that the presence of this aluminum in the initial solution, to the extent of 1.2% of the uranium by weight, inhibits the precipitation of lanthanum fluoride and lowers its carrying power for plutonium. As a result, the aluminum must be removed from the uranium before the metal is dissolved for the extraction process or the process must be modified to accommodate the aluminum. The effect is observed even in the presence of a large excess of fluoride ion over aluminum ion.

Perlman and I attended a conference on the Project Handbook, called by Herman Fussler, the librarian, in Room 209, Eckhart Hall at 10:00 a.m. The first edition is due June 10, 1943. Perlman raised the question of whether a write-up on extraction methods would be too long (200 pages) to be included in the Handbook. With regard to Chapter II, "Properties of Substances," Mulliken recommended that Lane, Coryell and I constitute ourselves a committee to investigate how the chapter should be reorganized.

Helen and I went to the movies tonight and saw "Dodge City" and "West of the Law."

"Furious Battles in Tunisia" reads the headline in today's newspaper. Heavy fighting is taking place on two-thirds of the Tunisian front.

Sunday, April 25, 1943

Gofman and Sheline arrived from Berkeley to attend the Laboratory Council Information Meeting on Chemistry scheduled for tomorrow.

Helen and I went to the Harrison Browns' for dessert and coffee, followed by an evening of cards, the game of "Hell."

Monday, April 26, 1943

Cunningham and Werner have completed their extraction of plutonium from the 40 pounds of neutron-bombarded UNH started last Thursday and

4/26/43

Friday. They have recovered about 170 micrograms of Pu^{239} and close to 10^{11} beta disintegrations per minute of 93^{239} ; the latter can serve as a tracer for the recovery of 93^{237} . Part of the Pu^{239} will be used to test further the carrying of plutonium by bismuth phosphate at high concentrations of plutonium. This is critical information that still needs to be pinned down for the concentrations of plutonium that will exist in the extraction plant at Site W.

This morning I gave my second lecture on nuclear chemistry in Room 102 of Kent Chemical Laboratory to the du Pont supervisors being trained for operation of facilities at Site X. My lecture dealt with the study of nuclear reactions.

I attended the Laboratory Council Information Meeting on Chemistry, along with Boyd, Burton, Cohn, Compton, Cooper, Coryell, Doan, Gofman, Hilberry, Johns, Miles, Mulliken, Potratz, Shapiro, Sheline, Spedding, Sugarman, Whitaker, Wigner and Willard. I presented the results of decontamination tests of various separation processes carried out on about 60-day material which show:

Wet fluoride: One oxidation-reduction cycle plus two decontamination cycles gives 10^6 reduction in beta activity. I included the important information that six cycles by our microchemists (in isolation of Pu^{239} from neutron-irradiated UNH) gives 3×10^8 decontamination from gamma activity.

Bismuth phosphate: One precipitation plus three decontamination cycles, reduced beta activity by 10^7 ; conditions were near W pile conditions, including use of zirconium.

Dry fluoride (not now seriously considered for W) factor of 50 per decontamination cycle.

Adsorption (silica gel process): Attempting to speed up process by adding NH_4Ac which permits increase in pH from 2.5 to 4.5. Around 95°C , plutonium is not adsorbed, but fission activity is, somewhat; might use two columns—one to remove fission activity and the other for plutonium.

I also summarized Stoughton's work on the gamma rays from Pa^{233} . I mentioned molecular distillation as a promising method of purification of plutonium. I also described the observations on the possible production of

4/26/43

microgram quantities of plutonium metal by sodium reduction of the fluoride.

Gofman then discussed the sodium uranyl acetate extraction and decontamination method—decontamination factors are being tested element by element. He reported on the separation of neptunium and plutonium in the sodium uranyl acetate cycles, indicating that 9% of the neptunium comes through in one cycle which means that three cycles will separate neptunium up to a factor of 1,000 from plutonium. Sheline reported on ultramicrochemical work at Berkeley, studying portions of the sodium uranyl acetate cycle. He finds over 90% of oxidized plutonium carried at ratios of varying from 2×10^7 to 0 (0 means no uranium carried). Solubility measurements on plutonium and uranium as a function of sodium concentration show a solubility of plutonium of 170 mg/liter at 4.0 moles sodium/liter and 75 mg/liter at 5.7 moles sodium/liter.

Coryell said that four men from my Section and four from his Section have been to St. Louis to study means of increasing Pu^{239} production through the use of uranium metal, etc. In reply to a question from Compton, he said that he hopes for an improvement factor of five but expects it will be more like two.

Helen went to a YWCA advisers' meeting from 2:00-4:00 p.m.

Gofman and Sheline had dinner with us this evening. At the Chemistry Division seminar afterwards, Sheline described the present status of the Berkeley research on the Sodium Uranyl Acetate Process, Gofman summarized their investigations of 93 chemistry and fission products and Stoughton gave a status report on our U^{233} program. Waldo Cohn played an amusing record which is a sort of parody on the cyclotron. After the meeting I had a beer with Ghiorso, Gofman, Sheline, Boyd and Coryell at Hanley's, a beer joint on 55th Street.

The newspapers today say that the battle in Tunisia continues to rage.

Tuesday, April 27, 1943

In experiments yesterday and today using their vacuum sublimation apparatus, Cunningham and Smith have brominated (with bromine) some of the plutonium metal produced by Kirk and Rosenfels. They carried out the bromination at 210°C and distilled the product at 250°C for an hour and find that about 40% of the plutonium distills, presumably as a bromination product. In a similar experiment yesterday they found that about 65% of the brominated plutonium distilled. The undistilled portion is probably due to oxide or unreduced fluoride present with the plutonium metal.

Patton finds somewhat better carrying of plutonium by bismuth phosphate from uranium-free solutions at Site W concentrations, up to 90%, when he heats the solution and precipitate to about 95°C for 30 minutes; this is better than his previous discouraging results but still not entirely satisfactory.

There was a meeting today of Balthis, Willard, Peery, M. D. Peterson, Apple, Thompson, Hugh W. Bellas, J. H. Peterson, Vincent, Dreher and Miller to decide on the conditions to be used in the semiworks operation of the bismuth phosphate extraction process. Points brought out in the discussion include: (1) Leave holdback carriers out of the extraction step for the time being. (2) If temperature of digestion (extraction step) cannot be held at 95°C, the time of digestion should be greater than 45 minutes. (3) The oxidation procedure to be used will be left open for the time being since the previously used method of dichromate in 6 N HNO₃ at 95°C causes corrosion. (4) Filtration will be used if the expected filters arrive on time. (5) Thompson volunteered to investigate the use of H₂O₂ for reduction. (6) Since only 5-10% of the UNH to be used in the first run will be active material, the difficulty of analyzing for fission product activity beyond one decontamination cycle makes the value of investigation of additional cycles doubtful.

Kohman distributed a memo and table (MUC-GTS-88) giving the estimated weights of fission products for various times of operation and cooling in terms of grams of element per 100 grams of 39 + 49.

4/27/43

I attended a meeting with Greenewalt, Cooper, Smith, Sutton and Coryell to discuss problems connected with the chemical extraction plants at Site W, their siting, etc. Greenewalt said he will make a choice between the Wet Fluoride and the Bismuth Phosphate Processes by a deadline of June 1. Greenewalt told us there will be two separate areas at Site W four miles apart, each with piles containing 200 tons of uranium and operating at a power level of 2,500 kw per ton. The chemical separation of plutonium will be performed, after 60 days of cooling of the uranium, in chemical separation plants housed in long buildings (canyons) at separate sites that are, in turn, separate from the pile areas.

After the meeting I wrote a letter to Greenewalt, who expressed concern about the prospects for adequate decontamination of Pu^{239} . I reviewed the recent laboratory results which show that the desired decontamination factor of 10^7 can be attained in three cycles of either the Bismuth Phosphate or Lanthanum Fluoride Processes. I pointed out that the microchemists have run through six wet fluoride cycles and obtained a gamma-ray decontamination factor of 3×10^8 , which exceeds by 30 the specifications set for delivery of the material from Site W. I also mentioned that in the Sodium Uranyl Acetate Process a decontamination factor of well over 10^5 has been reached and the question of whether 10^7 can be attained should be answered very soon. I told him we intend to run through a complete cycle on the ultramicrochemical scale using Site W concentrations of 94 and fission products for each of the precipitation procedures sometime in the future, but this will be the most difficult set of experiments which we have yet attempted. I explained that I consider such a complete run-through most important from the point of view of our uncovering anything which we might have overlooked in our thinking about the procedures as they apply to the Site W condition.

C. M. Cooper sent Compton a four-page memorandum giving a brief history of technical and engineering developments by the Project up to April 1943. The Technical Division, he states, was organized early in 1943 to include all the Project development studies, the purpose of which is to translate laboratory and theoretical information into the design, construction and operation of equipment to produce plutonium in metallic

4/27/43

form ready for final fabrication. He then summarized the activities of individual groups now included in the Technical Division, beginning with February 1941 when a small group with Wigner and R. R. Wilson at Princeton began the study of the penetration of fission and resonance neutrons in spheres of uranium oxide and of the $1/v$ law for fission. In December, Wilson left the group and studies were begun with H. Jupnik on some detail of the advantage factors for various-sized uranium-oxide lumps in a large graphite cube. The investigation of water as a coolant for a power plant was started. In April 1942 work was started on the effect of temperature on the resonance absorption of neutrons by spheres of uranium oxide, the vapor pressure of uranium and methods of purification of nitrate. In June 1942 a nucleus of the group moved to Chicago, where a study of melting and casting methods for uranium was begun.

T. V. Moore was retained in April 1942 as the first engineer on the Project. Other engineers soon followed and active work on the design of a helium-cooled pile was undertaken, because of its relative simplicity compared with the other designs then proposed. A decision to go ahead with the helium-cooled pile in collaboration with the Stone & Webster Company was reconsidered when du Pont took over. In view of the considerable progress that had been made in the design of a water-cooled pile, helium as a coolant was abandoned in favor of water. This group was reorganized under M. C. Leverett as the Engineering Technical Section; its function is experimental work of an engineering nature, necessary for the design and operation of the piles at Sites X and W.

In August 1942 C. M. Cooper joined the Project to initiate semiworks studies on chemical extraction processes. The work developed rapidly, necessitating a present staff of about 23 men. One separation process has been successfully carried through the development and into plant design, and now a second method is ready for consideration. In the reorganization of January 1943 this group was made part of the Technical Division under the name of Chemical Engineering Section, headed by W. Q. Smith. In the latter part of 1942 it became apparent that a group to work on process development, but on a scale intermediate between semiworks and the laboratory, was needed. J. B. Sutton was brought in from the du Pont Company to head such a Process Development Section.

4/27/43

Helen went to the Metro Y. Later she went to Helen Lane's with Wilma to see an apartment--they had coffee at our home afterwards.

We held our regular meeting of the Extraction Groups this evening. Brown gave a review of heavy water piles, including descriptions of designs for the type fueled by uranium metal and the type fueled by circulating UF_6 . I presented a rather complete description of the neutron physics and neutron balance in a graphite-moderated pile of the type being built at Site W.

Wednesday, April 28, 1943

Today Cunningham and Smith tried to chlorinate (using chlorine) some of the plutonium metal produced by Kirk and Rosenfels but were not successful in producing a volatile product.

A request to hire Jerome J. Howland, Jr., of the Department of Chemistry, University of Rochester, was sent to Stearns by Willard. Last Monday Stearns notified Milton Burton, at the request of James Franck, of his appointment as Section Chief of the section of Radiation Chemistry. During the month ending April 15, the Met Lab hired 148 new employees, including 21 Research Associates and 32 Research Assistants. Also, 21 employees were transferred to Site X.

Perlman and I provided John Wheeler with information on the danger of fire in dealing with solutions of uranyl nitrate in ether. Wheeler is collecting information in response to a phone call today from Ruhoff at the Mallinckrodt Chemical Works. We indicated we have had no difficulty with fire in a long experience in making ether separations of products from uranyl nitrate.

In a memorandum from Cooper to Compton, summarizing monthly progress in the Technical Division, he states that all essential information for the design of a wet fluoride separation plant at Site X has been completed and transmitted to the du Pont Company; however, work remains to be done to

4/28/43

achieve optimum operating conditions. Work in the immediate future will emphasize semiworks studies of the Bismuth Phosphate Process.

I attended the evening meeting of the Purification and Metal Production Groups of my Section. Others present were Baumbach, Brown, Cunningham, Davidson, English, Ghiorso, Jaffey, Katz, Katzin, Patton, Perlman, Rosenfels, Smith and Willard. Orlemann outlined analytical arrangement agreed on between Boyd's and our groups. The analytical work will be done by a unit whose manpower is drawn from both groups and has only this problem to handle.

Katz described his plans with Bond to study the $UF_4 + F_2 \rightarrow UF_6$ system with the help of U^{232} tracer as a stand-in for study of the $PuF_4 + F_2 \rightarrow PuF_6$ system. They have been having trouble with the carrying of U^{232} tracer by $Fe(OH)_3$.

English described the program of his group in the construction of special circuits—low geometry alpha counter not sensitive to the area of the sample, neutron counters of greater efficiency (Kohman), simple instrument to measure alpha particle ranges with high accuracy (Jaffey), fission counters for both slow and fast neutron fission, use of magnetic fields to permit alpha counting in presence of high beta backgrounds. Also, Kohman is to prepare pure polonium sources for use in studying alpha,n yields while Jarrett and Scott are working to improve Geiger counters.

Rosenfels and Baumbach described their studies using ThO_2 -lined quartz tubes which give the following results: U, UO_2 , UO_3 , UO_2F_2 and UF_3 heated in these evacuated vessels always end up as U_3O_8 , and the ThO_2 shows a yellow discoloration. Reduction of uranium oxide with Na gives some metal and UO_2 . Some suggestions were to use liquid NaK to introduce the reducing agent more easily (Katz); to use calcium amalgam for the same reason (Davidson); to use refractories containing no oxygen.

There was a Laboratory Council Policy Meeting, attended by members Allison, Cantril (representing Stone), Compton, Cooper, Doan, Franck, Hilberry, and Whitaker. Guests and observers were Spedding, Wigner, Peterson, Miles, Greenewalt, Mulliken and Stearns. In his "State of the Union" message Compton said the University of Chicago

4/28/43

has not yet signed its contract with the Army, but everything is in good order to do so soon. He announced that all research on the heavy water pile (P-9 project) will be at Chicago under the direction of Allison and Smyth. The pile will be at Argonne or Site X and du Pont will be kept informed because they will design production piles of this type should it still become necessary. He then outlined such a research program consisting of five parts: preliminary designs (Wigner, chairman of the Design Committee, and Vernon, vice-chairman); physics studies; corrosion studies, miscellaneous problems; and plans for the first semiworks plant. Urey has been asked by the Army to undertake other matters and so will not spend full time on the Chicago project, but a number of chemists will come from Columbia University. Whitaker announced that the official name of the Metallurgical Project at Site X is Clinton Laboratories; identification with Chicago is to be avoided. At Compton's suggestion the Council approved the chemistry building for Site X. Hilberry said that shortly after signing the Army contract we must submit a statement of our program. Compton added that within ten days we must furnish a schedule on estimated dates of initiation and completion of the program's major items. He then mentioned what the items are: supply of information for the water-cooled graphite pile and then the heavy water units; chemistry of separations and decontamination; and final purification of product and fabrication. Franck questioned the wisdom of discontinuing work on the adsorption separation process—this process has been put into question because of the difficulties encountered by the chemical engineers. Compton said the question of whether the Berkeley chemistry group will move to Chicago has not yet been settled. Compton concluded the meeting by announcing that the Argonne pile reached a power level of 40 kw yesterday.

Thursday, April 29, 1943

Cefola received his Pu²³⁹ sample back from English and Ghiorso, and continuing from the point he was on April 21, he purified it further with precipitations of plutonium peroxide. Then he made an assay with the help

4/29/43

of Cunningham, counting an aliquot on the low geometry alpha counter and determined that a total of 145 micrograms of pure Pu^{239} has been recovered in the final peroxide precipitate by the long procedure which started on March 8; there is additional plutonium in by-product fractions that can be recovered.

Baumbach has been making tests on the reduction of UF_4 with active metals in ThO_2 crucibles in a quartz system. Today he attempted reduction of UF_4 with calcium; but there didn't seem to be any uranium metal formed, as shown by the lack of reaction of the product with 1.2 N HCl.

Cunningham and Smith chlorinated (with chlorine) some of the plutonium metal produced by Kirk and Rosenfels at 170°C and distilled the product at 350°C for an hour, and find that about 35% distills, presumably as a volatile plutonium chloride. Again the undistilled portion must be due to oxide or unreduced fluoride in the plutonium metal.

Perlman conducted the Research Assistants seminar in my office this evening. He had Crawford give a description of the effect of sample thickness on alpha counting and Beaton give a theoretical description of adsorption separation processes. Then Perlman himself gave a description of the chain-reacting pile, its production of plutonium including the pertinent nuclear reactions and a summary of the rate of production of plutonium with respect to the power of the pile.

At the Met Lab Research Associates seminar, which was also held this evening, Herbert Anderson described the neutron column planned for CP-2 (Chicago Pile no. 2) at the Argonne Laboratory.

Reports appear in the paper today of U.S. and British air raids on Burma in addition to reports on the wars in Tunisia and an English Channel battle.

Friday, April 30, 1943

"Chemical Research—Production and Extraction of 94, Report for Period April 16–April 30, 1943," with the report number CN-633, is being issued. The topics covered are the following: Wet Fluoride Process for extraction and decontamination of plutonium. James, Knox and Kohman. It has been found that aluminum, which will be present from its use as a cladding material for the uranium metal, inhibits the precipitation of lanthanum fluoride and lowers its carrying power for plutonium. The effect is serious enough to necessitate either removing the coating before dissolving the uranium or modifying the extraction procedure.

Bismuth Phosphate Method for extraction and decontamination of plutonium. Miller. The oxidation conditions previously prescribed for the process have been found to be excessively corrosive. A satisfactory laboratory method has now been found which oxidizes plutonium quantitatively in 2 N HNO₃ at 75°C (as contrasted to 6 N HNO₃ at 95°C). This is done with the use of 0.002 M Ce⁺⁴ and 0.02 M K₂Cr₂O₇; the presence of the Ce⁺⁴ prevents precipitation of bismuth phosphate upon dilution to 2 N HNO₃.

Adsorption methods for extraction and decontamination of plutonium. Beaton, Cooper, Fries, La Chapelle, Stoughton, Sheft and Turk. Further investigations show that adsorbed plutonium is quantitatively eluted from silica gel in as little as one minute's time of contact with either 1 N or 6 N HNO₃. The moisture content of certain samples of the gel as received and ground for use has been found to be 4%. Further investigations of the properties of heat-treated zirconium phosphate as an adsorbent for plutonium indicate that: (1) the temperature of treatment (in the range of 100°–800°) does not appreciably affect the characteristics of the adsorbent; (2) the rate of adsorption of plutonium from uranyl solutions is rather low although the percentage adsorbed at equilibrium is equivalent to that with silica gel; (3) adsorption of plutonium in the absence of uranyl ion, at pH = 0 to pH = 2.5 is nearly 100% complete in one minute at solution to solid ratios where it would be only 40–50% complete in the presence of 16% UO₂(NO₃)₂·6H₂O.

Volatility methods for the extraction and decontamination of plutonium. Brown, Bohlmann and Hill. In order to obtain further information about the possible separation of fission activity from the UF₆ in a

4/30/43

continuously operating UF_6 pile, a series of four successive distillations of a sample of bombarded UF_6 has been carried out. Separation of the uranium from 99% of the plutonium and 99% of the gamma fission activity was achieved. In a continuously operated extraction unit for a UF_6 pile there will be a certain equilibrium distribution of each fission species among the pile, the concentration still and the disposal system. Mathematical expressions for this distribution in terms of the decay constant of the species and the fractional bleeding rates from the pile and the still have been developed. A revised dry fluoride process for the extraction of plutonium from the uranium metal of a chain-reacting pile is suggested. It involves converting the metal to a mixture of fluoride and oxide with HF and steam at 500° - $700^{\circ}C$ followed by fluorination at $500^{\circ}C$. The plutonium may readily be condensed at a higher temperature than that at which the UF_6 condenses. Bismuth may be used as a carrier for the plutonium. This type of extraction would involve less corrosion hazard and a lesser problem of temperature control than was present in the dry fluoride method originally proposed.

General problems in the chemistry of plutonium. Davidson has prepared a relatively concentrated "master solution" of inactive isotopes of fission products in the proportions to be produced at Site W. These will be used to test the effect of these elements on plutonium recovery, decontamination and the properties of precipitates.

Patton is finding excellent carrying, about 99%, of plutonium by bismuth phosphate from 10% UNH solution at a bismuth to plutonium ratio of 100. The remaining worry is the adequacy of the carrying from uranium-free solutions at Site W concentrations.

I received a wire from Alfred Nier at Columbia University advising me that he will arrive in Chicago about Saturday noon and would like to see me if possible.

Semiworks run C-13 is in progress, consisting of a wet fluoride extraction plus three decontamination cycles. The starting material was thirty pounds of uranium nitrate from dissolved, bombarded oxide (Chicago III, 60 days bombardment, 177,000 microampere-hours, cooled 95 days),

4/30/43

containing approximately 30 micrograms of plutonium. The extraction cycle was carried out using $K_2Cr_2O_7$ and As_2O_3 for the oxidation and reduction steps. All decontamination cycles are employing peroxydisulfate plus Ag^{+2} and SO_2 for oxidations and reductions, and all coupling is being done by zirconium complexing. Extraction and decontamination cycles are being carried out in semiworks equipment, ending up with a product precipitate of approximately three grams of lanthanum as lanthanum fluoride sludge. The product will be delivered to Knox of my Section, who will carry through two more decontamination-concentration cycles and determine an accurate plutonium balance.

We now have in our Section C-I a total of 51 people—these include 27 Research Associates (Perlman, English, Brown, Willard, Magel, Cefola, Jaffey, Cunningham, Kohman, Ghiorso, Thompson, Davidson, Kirk, Orlemann, Stoughton, Rosenfels, Fries, Cooper, Katz, Patton, Beaton, Dreher, Smith, H. Baumbach, Bond, Katzin and me); 17 Research Assistants (Covey, James, Knox, Hill, Koshland, Turk, Werner, Jarrett, Crawford, Bohlmann, Miller, La Chappelle, Dallas, Scott, Sheft, Schulze and N. Baumbach); 4 laboratory helpers (Paulsen, Fulan, Summers, Young); and 3 secretaries (Smith, Moore, Tharpe). Figure 31 shows the present disposition of laboratory benches, hoods, facilities, etc., throughout our rooms and Figure 32 depicts the disposition of our people in these rooms.

4/30/43

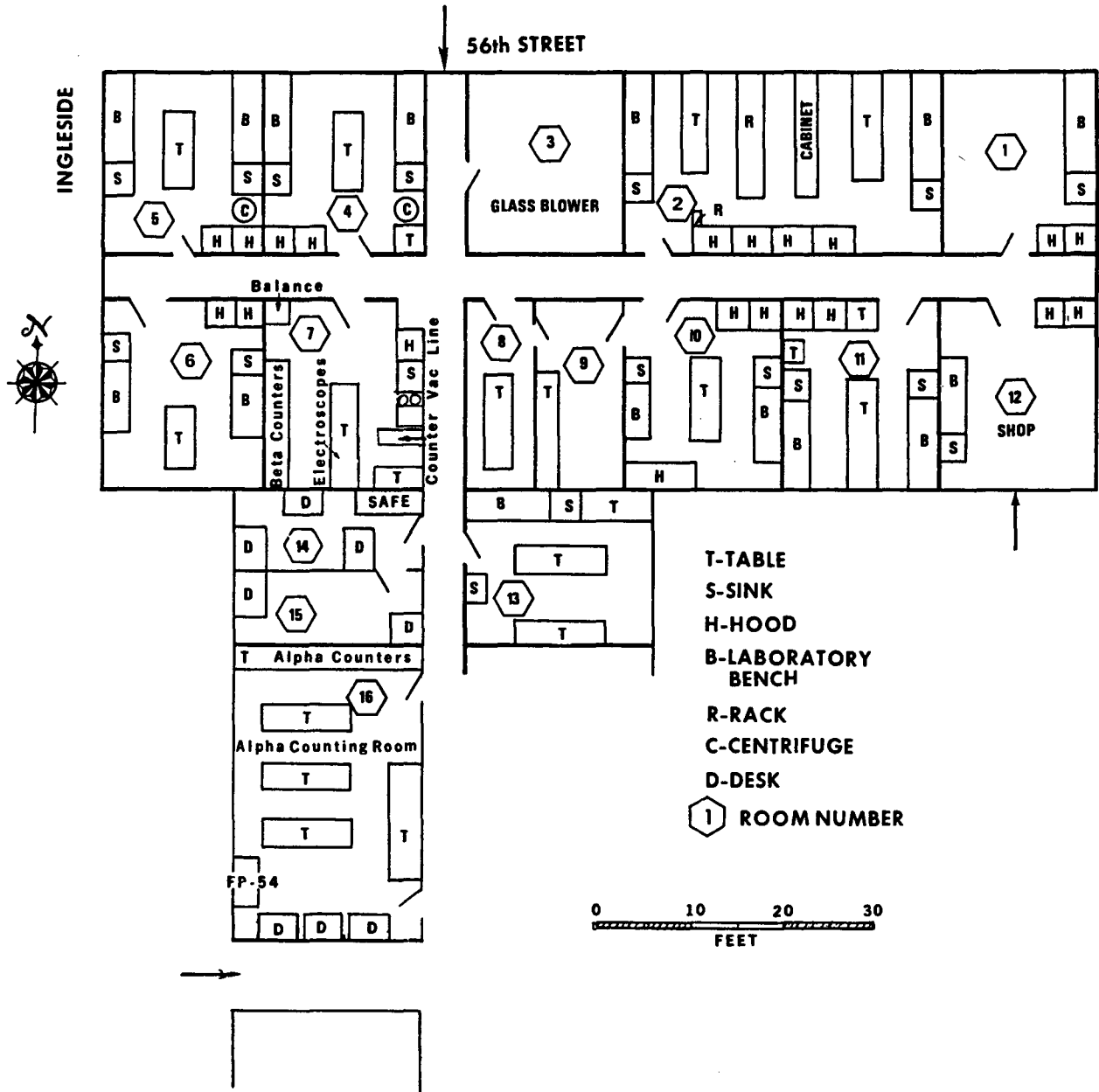

Fig. 31 Floor plan and layout of laboratory benches, hoods, facilities, etc., for Section C-I in New Chemistry Building, end of April 1943. (XBL 758-3805)

4/30/43

5 KOHMAN JAMES KOSHLAND	4 THOMPSON DAVIDSON COOPER DREHER MILLER	3 OSTAPOWICZ	2 STOUGHTON KATZIN BOHLMANN BOND	BROWN HILL SCHULZE JAFFEY	1 MAGEL DALLAS
6 PERLMAN ORLEMANN KATZ KNOX	7 JARRETT SCOTT	8 CUNNINGHAM	9 WERNER CEFOLA SMITH PATTON N BAUMBACH	10 WILLARD TURK BEATON FRIES LA CHAPELLE SHEFT	11 COVEY SUMMERS PAULSEN FULAN YOUNG
	14 THARPE E. SMITH MOORE	13 KIRK H BAUMBACH ROSENFELS			
	15 SEABERG PERLMAN				
	16 ENGLISH GHIORSO J. CRAWFORD				

Fig. 32 Room assignments of members of Section C-I, late April 1943.
(XBL 768-3255)

I N D E X

- Abbott, M. D., 614
 Abelson, Philip H., 24,28,150
 Abraham, Bernard M., v,522
 Abrams, Stanley T., 34,124,176,
 492
 Acken, M. F., 675
 Adams, Gayle E., 34
 Adamson, Arthur, 421,441,534,
 542,556,560,573,585,595,
 598,616,641,667
 Aebersold, Paul C., 166
 Akers, Wallace A., 366
 Allison, Samuel K., 10,13,17,
 30,50,71,73,74,76,77,88,90,
 93,100,101,108,118,119,127,
 143,145,198,214,224,253,255,
 268-270,273-275,284-287,288,
 289,293,298,314,315,318,333,
 354,355,358-360,374,375,377,
 383,384,392-394,408-411,414,
 420-422,437,439,441,444,445,
 447,456,459,484,486,494,498,
 502,503,515-517,525,530,537,
 547,556,562,565,575,576,584,
 591,595,600,614,621,622,641,
 654,683,684
 Anderson, Herbert L., 93,170,
 357,390,433,525,526,532,602,
 614,685
 Apple, Richard S., 219,246,249,
 250,257,264,276,311,351,440,
 534,598,599,640,644,679
 Aranoff, Sam, 32
 Armstrong, Walter W., 541
 Asprey, Larned B., v
 Auerbach, Charles, 26
 Auger, Pierre, 381,499

 Babcock, S. H., 266,267
 Bacher, R. F., 256
 Baird, D. O., 544,570
 Balthis, Joseph H., 541,609,
 610,618,675,679
 Baumbach, Harlan, 134,182,198,229,
 230,268,275,278,286,314,392,
 521,552,593,614,619,646,658,
 661,666,669,670,673,683,685,
 688
 Baumbach, Nathalie, 182,278,314,
 646,649,653,656,661,688

 Baxter, Gregory P., 525
 Beaton, Roy H., 520,529,574,581,
 623,641,645,665,685,686,688
 Beaufait, L. J., 492,666
 Bellas, Hugh W., 578,679
 Benedetti-Pichler, Anton Alexander,
 38,39,41,78,96,424,425,436,453,
 490,578,581
 Bennett, W. E., 256
 Blacet, Francis, 46,546,645
 Blaedel, Walter J., 546
 Blair, Robert C., 338
 Blanchard, Charles G., 15,109,124,
 218,363,422,492
 Bloch, Felix, 256
 Bohlmann, Edward G., 454,464,522,
 524,544,550,559,566,587,588,
 607,608,634,666,686,688
 Bolton, E. K., 331
 Bond, Arthur C., 32,522,533,648,
 688
 Bonner, Norman A., 25,65,91,100,
 111,125,127,151,152,172,209,
 211
 Booth, Eugene T., 36
 Borst, Lyle B., 357,411,441,506,
 517,533,615
 Bowers, George, 99,128,164
 Boyd, George E., v,8,10,12-14,
 20,53,71,84,115,130,170,224,
 300,318,392,421,441,461,475-
 477,481,486,505,530,534-536,
 542-544,548,549,551,556,573,
 574,585,595,598,605,616,619,
 641,642,661,667,668,677,678,
 683
 Boyer, H. K., 433
 Brady, E. L., 645
 Bray, William C., 424
 Breit, Gregory, 24,28,34,52,75
 Breslow, David S., 7,14,111,127,
 150,292
 Brewer, Leo, 492,638,645
 Briggs, Lyman J., 14,24,27,28,35,
 147,150,239,248,254,366
 Brown, Adele, 516,586
 Brown, Harrison, 15,24,25,27,29,
 42,44,46,47,50,51,59,71-73,
 77,79,81-83,89,92,95-97,102,
 103,105,107,116,121,122,130,

Brown, Harrison, (con't.)
 137,138,140,152,153,165,166,
 177,178,184,188,190,204,209,
 212,218,224,226,246,262,276,
 311,312,318,326,329,330,335,
 344,349,381,389,390,399,401,
 403-405,419,421,428,430,432,
 433,441-443,454,459,460,464,
 470,474,489,506,508,511,516,
 522,524,529,534,544,545,551,
 556,559,566,577,581,587,588,
 593,594,598,607,608,610,611,
 614,618,620,634,639,645,646,
 648,655,657,659-661,666,667,
 670,671,673,676,682,683,686,
 688
 Brown, Herbert, 32,185
 Burns, J. A., 430
 Burton, Frances, 536
 Burton, Milton, v,33,38,48,
 50,53,54,70,71,88,93,103,
 115,118,308,314,316,318,333,
 340,392,421,427,441,462,463,
 471,481,505,506,542,549,584,
 589,590,595,602,605,614,618,
 619,642,666,669,672,677,682
 Bush, Vannevar, 94,254,269,385
 Butenhoff, Robert L., v

 Calvin, Melvin, 32,34,60,62,64,
 68,102,260,278,434,446,479
 Camenson, C. E., 433
 Campbell, George W., Jr., 186,
 546,645
 Campbell, J. Arthur, 461,492,
 529
 Cannon, C. V., 542
 Cantril, S. T., 200,293,300,302,
 358,362,374,411,468,505,517,
 534,536,547,572,575,584,683
 Carmichael, Leonard, 488
 Carruthers, Wallace H., 438
 Cefola, Michael, 39,41,47,49,56,
 78,81,86,112,124,129,140,143,
 145,152,165,175,177,193,195,
 209,210,218,226,228,242,247,
 261,263,276,283,304,311,312,
 327,332,334,340,349,404,416,
 425,427,432,436,443,450,453,
 464,470-472,480,506,510,532,
 569,571,598,618,620,668,669,
 674,684,688
 Chadwick, James, 366

 Chaikoff, I. Lyon, 276,280,281
 Chilson, Frances, 524,580,582,
 646
 Chilton, T. H., 293,298,331,336
 Chipman, John, 494,496
 Christy, Robert F., 17,30,135,
 353,362,374,375,377,421,526,
 568,614,626
 Churchill, Winston, 40,93,387,
 486,550
 Clifford, Alan F., 650,660,665
 Cohn, Waldo E., 303,420,542,
 572,595,677,678
 Cole, Kenneth S., 293,300,302,
 358,362,374,391,400,504,
 505,517,530,542,556,565,
 571,628
 Collins, J. A., 675
 Compton, Arthur H., 5,8,10,14,
 25,26,28,30,32,43,44,45,53-
 56,59-61,71,73,76,77,88,89,
 93,94,100,101,118,120,123,
 130,131,139,145,146,157,
 159,160,214-217,223,224,
 239,240,248,253-255,265,
 267-271,273,274,284,285,
 288-291,293,295-299,301,
 302,314-316,328,329,335-
 337,339,343,346,354,355,
 358-362,366-368,374-378,
 390,392,394-396,410,412,
 418,420,424,434,436-438,
 444,453,454,456,457,467,
 472,475-477,484,488,494,
 498,502-505,517,520,525,
 530,531,534,536,542,547,
 549,552,556,565,566,568,
 574-576,579,584-586,591,
 595-597,600,602,604,614-
 616,621,624,629,632,637,
 641,642,653-655,662,671,
 677,678,680,682-684
 Compton, Betty, 509,537
 Conant, James B., 15,18,48,94,
 160,239,248,254,269,290,315,
 339,366,374,384,394,395,412,
 626
 Conklin, Frederick R., 338
 Connick, Robert E., 150,172,
 177,209,248,398,399,402,470,
 492,533,589,591,593,595,597,
 598,666
 Connor, Phyllis, 536

Cook, Oscar A., 34,492,666
 Cooksey, Don, 67,166,248,279
 Cooper, Charles M., 163,169,178,
 208,219,270,271,273,274,285,
 289,290,298,300-302,307,312,
 314,316,347,350,355,364,374-
 377,379,396,399,404,408-411,
 421,427,430,436,439,441,475-
 477,484,488,494,497,503-505,
 509,515,517,525,527,529,530,
 534-537,542,543,545,547,548,
 551,556-558,560,564,565,568,
 573,575,576,578,584-586,595,
 598,600,601,614,616,617,627,
 641,644,653,662,669,671,672,
 677,680-683
 Cooper, Mary, 658,675
 Cooper, Vance R., 415,481,507,
 547,548,578,590,593,598,645,
 660,665,673,675,686,688

 Coryell, Charles D., 9,10,31,41,
 53,54,70,71,73,74,88,93,115,
 119,126,143,186,218,300,308,
 316,318,357,392,421,441,453,
 462,481,493,498,505,518,525,
 534-536,542,546,549,567,595,
 598,599,601,606,614,619,632,
 643,645,652,655,669,675-678,
 680
 Coryell, Gracemary, 31, 70
 Covey, Elwin H., iv,v,vi,5,29,
 44,48,50,58,77,79,89,98,99,
 128,136,137,145,148,152,179,
 193,204,222,244,247,265,273,
 311,318,323,328,334,353,404,
 422,428,451,458,464,478,479,
 480,491,497,503,513,553,556,
 560,619,639,644,652,672,688
 Craig, Roderick, 78,80,85,89,
 175,267,404,433,492,523,570,
 573,574,577,581,582
 Crandall, H. W., 492,666
 Crawford, John A., v,414,439,
 464,550,673,685,688
 Crawford, Lorraine, v
 Crawley, Virginia, 575,639
 Crenshaw, Major, 248
 Creutz, Edward C., 120,333,361,
 408,437,494,496,517,556,558,
 648,650
 Crist, Ray H., 614

 Crowell, William R., 373
 Cunningham, Burris B., vi,40,65,79,
 81,99,112,140,143,145,152,153,
 161,163,165,177,178,184,188,
 189,190-192,195,199,202,203,
 209,210,217,226,228,232,234,
 242,243,246,247,261-263,276,
 281,282,288,291,292,303,304,
 305,308-312,317,318,326,331,
 334,344,345,348,382,388,392,
 401,404,411,413,415,418,421-
 423,426,427,432-435,440,441,
 443,450,451,454,456,460,461,
 464,470,473,474,486,487,489,
 496,508,510,517,532,534,537,
 539,540,545,546,548,559,570,
 571,574,577,580-582,586,590,
 593,594,598,599,602,603,609-
 611,618-620,633,639,645,646,
 653,655,656,659,661,662,664,
 667,669,670,674,676,679,682,
 683,685,688
 Cunningham, Irene, 595
 Curie-Juliot, I. & F., 38

 Dallas, Nick S., 425,504,505,562,
 597,652,663,688
 Davidson Norman R., vi,478,499,
 523,541,558,559,577,588,592,
 598,612,618,620,635,650,657,
 664,669,670,683,687,688
 Davis, W., 88
 Debye, Peter, 400
 Dempster, Arthur J., 270,562
 Dixon, John, vi
 Doan, Richard, 2,10,73,77,83,86,
 91,93,100,135,145,159,224,226,
 273,293,298,356,358,359,437,
 439,444,459,475,484,494,496,
 503,515,517,525,530,533,536,
 542,556,565,566,575,630,641,
 653,654,671,675,677,683
 Dodgen, H. W., 492,556,574
 Dodson, Dick, 46
 Doolittle, James H., 671
 Dorn, J., 492
 Dreher, Dagmar, 490,632
 Dreher, J. Leonard, 478,490,580,
 585,593,619,623,632,645,660,
 664,673,675,679,688
 DuBridge, Lee, 18,31

Duffield, Robert B., 34, 67, 105,
 109-111, 116, 125, 127, 152, 155,
 156, 164, 166, 177, 209, 226, 248,
 250, 277, 327, 356, 363, 402, 424,
 445-447, 470, 492, 533, 589
 Dunning, John R., 35, 38, 134,
 142, 266, 422
 Eastman, Ermon D., 64, 127, 156,
 183, 446, 459, 461, 487, 492, 529,
 560, 564, 566, 576, 579, 591, 592,
 595, 597, 604, 610, 611, 639
 Eisenhower, Dwight D., 93, 499
 Elliott, Norman, 508, 525, 595,
 655
 Embry, Norris W., 452, 556
 Emery, Clyde R., 441
 Engelkemeir, Donald W., 186,
 546, 645, 655
 English, Spofford G., 7, 15, 16,
 19, 25, 44, 46, 48, 50, 51, 72, 73,
 78, 79, 81, 85, 88, 89, 92, 98, 100,
 107, 108, 111, 117, 123, 137, 142,
 160, 167, 181, 189, 192, 207, 209,
 220, 224, 238, 243, 244, 246, 247,
 253, 264, 275, 277, 282, 304, 311,
 356, 362, 386, 413, 422, 443, 444,
 452, 464, 506, 508, 533, 562, 567,
 581, 590, 593, 610, 611, 620, 645,
 649, 653, 655, 659, 663-665, 668,
 669, 673, 674, 683, 684, 688
 Ericson, Edith, 661
 Ericson, Rudolph, 661
 Evans, R. Monte, 437
 Failla, Gioacchino, 362
 Fajans, Kasimir, 15, 40, 41, 119, 157,
 485
 Farmakes, John, vi
 Farr, Henry V., 662
 Fermi, Enrico, 10, 30, 52, 73, 74, 77,
 83, 84, 86, 87, 88, 91, 93, 98, 100,
 108, 118, 119, 120, 133, 145, 159,
 164, 169, 172, 174, 175, 193, 198,
 200, 217, 222-224, 254, 255, 268,
 269, 271, 273, 284-287, 289-291,
 293, 295, 298, 299, 302, 307, 308,
 314-316, 330, 333, 343, 347, 348,
 358, 361, 373-377, 390, 392-396,
 408-411, 433, 434, 437, 439, 444,
 472, 475, 484, 488, 502, 517, 521,
 525, 530-532, 535, 536, 542, 543,
 547, 556, 568, 575, 576, 584, 591,
 595, 614, 621, 624, 641, 653-655
 Fermi, Laura, 434, 471
 Fieldhouse, Margaret, vi
 Fields, Paul, vi
 Finholt, A. E., 522
 Flagg, John F., 552, 581, 583
 Florin, Al, vi
 Florin, Kay, vi
 Fontana, Beppino J., 7, 26, 34,
 66, 104, 110, 112, 133, 134, 172,
 176, 213, 214, 272, 387, 402, 405,
 419, 492, 513, 529, 546
 Foote, Frank G., 534
 Fowler, Robert D., 35
 Franck, James, 8, 87, 308, 316,
 333, 392, 421, 441, 444, 456, 457,
 464, 481, 484, 488, 494, 503, 505,
 506, 513, 517, 520, 525, 530, 534,
 536, 537, 542, 547-549, 551, 556,
 558, 560, 565, 568, 573-576, 584,
 585, 595, 598, 600, 604, 614, 616,
 619, 621, 629, 632, 641, 642, 651,
 653, 655, 667-669, 671, 682-684
 Fred, Mark S., vi, 544
 Fredrickson, J. E., 492
 Freedman, Mel, vi
 Freeman, Y. Frank, 521, 552
 Friedell, H. L., 517
 Friedlander, Gerhart, 15, 18, 27,
 28, 34, 40, 43, 48, 61, 62, 75, 76,
 108-111, 116, 143, 155-157, 164,
 167, 176, 213, 357, 372, 423, 456,
 508, 651
 Friedman, Francis L., 135, 362,
 411, 614
 Fries, Bernard A., 276, 520, 533,
 572, 574, 579, 583, 588, 598, 602,
 635, 647, 660, 665, 686, 688
 Frodin, Muriel Kathryn, 253
 Froman, D. K., 468, 505, 626
 Fulan, Emil, 503, 688
 Fulbright, Harry W., 26, 427, 428,
 452, 461, 479, 508, 549
 Furman, N. H., 71
 Furnas, C. C., 520
 Fussler, Herman, 676
 Gaarder, Sydney, iv
 Garner, Clifford S., 54, 55, 65,
 91, 99, 100, 111, 112, 127, 151,
 152, 164, 166, 172, 177, 209, 211,
 226, 248, 277, 305, 327, 350, 398,
 399, 402, 424, 445-448, 468, 469,
 471, 488, 492, 494, 512, 516, 523,
 533, 549, 589
 Garrison, Frances, 536

Garrison, Warren M., 536,595,598,
666
 Gary, T. C., 293,298,331,367,377
 George, Warren, 338
 Ghorso, Albert, vi,108,117,124,
156,175,192,214,220,246,272,
275,311,386,389,413,414,422,
439,443,444,464,471,524,549,
550,563,579,590,599,620,631,
635,639,651,655,658,661,663,
668,669,673,674,678,683,684,
688
 Ghorso, Wilma, 108,125,175,192,
518,524,525,530,536,567,590,
591,599,617,631,651,653,655,
658,659,661,675,682
 Giauque, W. F., 54
 Gibson, G. E., 60,64
 Gilbreath, James, 32,522
 Gilman, Henry, 313,319
 Gish, Eleanor, 17
 Glendenin, Larry, vi
 Goebbels, J., 492
 Goering, H., 492
 Gofman, John W., 7,8,14,19,34,42-
45,49,52,55,61,62,66,67,72,75,
76,92,104,109-113,115,116,123,
127,133,134,142,143,145,147,
151,155,156,164,166-169,172,
173,177,209,211,220,226,240,
248,250,266,272,277,278,280,
307,308,319,322,324,327,329,
356,357,363,364,386,387,398,
399,402,405,407,408,422,423,
448,461,470,471,473,478,479,
488,492,494,512,516,523,533,
540,549,551,553,559,563,564,
566,589,633,644,672,676-678
 Goldschmidt, Bertrand L., vi,
40,139,145,152,153,165,198,
200-202,206,219-222,228,246,
251,252,262,281,310,311,317,
330,499,500,506,509,528
 Grady, James T., 201,203
 Grafton, Capt., 224,253,293,
298
 Grahame, David C., 498
 Graves, Alvin C., 529,571
 Graves, G. D., 600
 Greager, O. H., 655,657,667
 Greenberg, David, 373
 Greene, Priscilla, 215

Greenewalt, Crawford H.
314,331,355,367,377,390,394,
436-439,441,475,476,484,491,
500,502,503,535,547,548,568,
569,575,576,578,579,586,600,
601,623,641,680,683
 Griggs, Iva B., 68
 Grosse, Aristid V., 36,38
 Groves, Leslie R., 269,274,284-
286,290,293,298-302,331,354,
355,358,366,367,403,412,424,
448,454,473,502,518,524,527,
530,536,543,547,565,570,595,
596,620,624,637,651,653-655
 Gucker, Frank, 46
 Gueron, Jules, 499
 Gullberg, Jonas E., 267,404
 Hagemann, French T., 659
 Hahn, Otto, 420,581
 Halban, Hans von, 5,8,34,56,
139,310,354,499,584
 Hall, David, 541
 Hall, Jane, 541
 Hall, Norris F., 400,415,417
 Hamaker, John W., 7,14,32,34,
67,90,111,127,138,142,143,
145,150,152,166,175,226,248,
257,292,471,492,560,564,589,
591,597,666
 Hamilton, Joseph G., 28,32,36,
37,43,44,56,61,67,75,76,78,
80,85,87,89,95-97,125,142-
144,151,155,158,176,178,183,
222,273,279,280,292,314,338,
341,353,356,387,391,400,408,
410,412,413,448,475,494,529,
551,553,571,619,648-650,672
 Harkins, William, 32,41
 Helmholtz, A. Carl, 150
 Heussenstamm, Peter, 546,644
 Heydenburg, N. P., 223,251,256,
265,275,282,292
 Hilberry, Norman, 5,8,10,19,30,
73,77,93,100,120,159,214,224,
293,298,302,336,339,357,358,
362,364,394,408,410,411,421,
436,474,484,488,494,503,517,
520,525,530,536,542,547,556,
565,573,575,576,584,595,600,
614,621,625,641,653,669,671,
677,683,684

Hildebrand, Joel, 230
 Hill, David, 74, 79
 Hill, Orville F., vi, 72-74, 79, 81-
 83, 92, 95, 96, 102, 107, 121, 122,
 138, 166, 177, 178, 185, 188, 190,
 198, 204, 209, 212, 218, 226, 246,
 262, 276, 311, 326, 335, 344, 349,
 381, 389, 401, 403, 404, 419, 430,
 432, 433, 442, 443, 454, 455, 459,
 464, 470, 489, 511, 522, 524, 529,
 544, 550, 559, 566, 587, 588, 590,
 607, 608, 634, 666, 686, 688
 Hindman, Clark, vi
 Hitler, Adolf, 492
 Hobart, J. C., 631
 Hoekstra, Henry, vi, 32, 522
 Hogness, Thorfin, 32
 Hollander, Margie, vi
 Howe, John P., 106, 308, 361, 392,
 494, 496, 508, 554, 590, 610, 614,
 639
 Howe, Marilyn, 554, 666
 Howland, Jerome J., vi, 682
 Hull, Donald E., 42, 79, 266
 Hutchins, Robert, 286
 Hutchison, Claude B., 89
 Hyde, Earl K., vi, 522
 Hyman, Herb, vi

 Jaffey, Arthur H., vi, 78, 99,
 121, 137, 140, 152, 158, 170, 173,
 175, 183, 186, 193, 198, 201, 210,
 219, 228, 242, 261-264, 267, 281,
 283, 303, 305, 311, 326, 334, 345,
 348, 349, 368, 388, 430, 432, 433,
 441, 443, 461, 464, 478, 511, 518,
 532, 598, 655, 664, 669, 672, 673,
 675, 683, 688
 James, Ralph A., 26, 44, 50, 58,
 72, 78, 79, 80, 85, 88, 92, 111,
 160, 167, 177, 181, 189, 198, 206,
 207, 209, 218, 243, 247, 282, 304,
 311, 362, 407, 416, 427, 439, 440,
 443, 459, 464, 480, 496, 532, 550,
 592, 607, 635, 650, 656, 660, 664,
 665, 675, 686, 688
 Jarrett, Alan A., 132, 192, 311,
 464, 546, 550, 645, 673, 683, 688
 Jeffries, Zay, 621
 Jenkins, Francis A., 510, 522,
 560, 570, 580
 Jenny, Hans, 581

 Jensen, Lyle, 659
 Jesse, W. P., 316, 534, 558
 Jilek, Walter, vi, 77, 79, 128,
 179, 311, 312, 497, 498
 Johns, Iral B., 8, 10, 11, 13, 340,
 392, 442, 485, 515, 533, 542, 595,
 677
 Johnson, C. R., 331
 Johnson, Fred D., 464
 Johnson, Gordon, 415, 417
 Johnson, Lloyd, 68, 336
 Johnson, Warren, 32
 Jones, Haydn, 468, 505
 Jupnik, H. 681

 Kamen, Martin, 16, 29, 34, 42, 95,
 96, 104, 125, 155, 183, 230, 241
 Katz, Joseph J., iii, 32, 522,
 609, 620, 648, 651, 669, 671, 683,
 688
 Katzin, Leonard I., vi, 604, 672,
 674, 683, 688
 Kennedy, Adrienne, 615
 Kennedy, Joseph W., 5, 8, 12, 13,
 17, 34, 42, 44, 55, 61, 64, 66, 111,
 115, 116, 127, 159, 166, 236, 238,
 256, 266, 267, 278, 281, 292, 309,
 322, 328, 335, 393, 424, 445, 447,
 454, 455, 544, 551, 570, 615, 619,
 632, 633
 Kent, J. W., 350
 Ketelle, Bruce H., 667
 Kihara, Sylvia, vi
 King, E. L., 492, 666
 King, M. V., 492
 Kirk, Paul L., 40, 65, 112, 153,
 175, 260, 266-268, 281, 332, 391,
 392, 404, 413-415, 418-420, 429,
 433, 440, 447, 448, 455, 462, 464,
 491, 499, 506, 518, 523, 540, 546,
 566, 573, 581, 582, 586, 587, 592-
 597, 603, 609, 610, 611, 619, 620,
 639, 645, 655, 659, 663, 669, 670,
 673, 679, 685, 688
 Kirkpatrick, E. E., 285
 Kirst, W. E., 445
 Kittredge, Mabel, 157
 Klein, August C., 293, 298, 302,
 338
 Knight, J. D., 522
 Knox, Frank, 323

- Knox, William J., vi, 26, 44, 57, 58,
72, 79, 82, 88, 90, 91, 95, 102, 117,
131, 133, 149, 165, 180, 191, 198,
202, 206, 209, 225, 246, 249, 250,
257, 264, 276, 311, 317, 318, 322,
348, 401, 464, 496, 506, 523, 532,
550, 558, 577, 581, 592, 647, 651,
665, 686, 688
- Koch, Charles W., 420
- Kohman, Truman, vi, 80, 144, 148,
152, 158, 170, 173, 175, 183, 186,
193, 198, 201, 219, 228, 233, 261,
262, 281, 311, 320, 322, 355, 400,
401, 416, 427, 463, 468, 464, 469,
518, 528, 533, 560, 567, 588, 598,
620, 655, 663, 665, 669, 673, 675,
679, 683, 686, 688
- Korzybski, Alfred, 429, 442
- Koshland, Daniel E., vi, 26, 27,
45, 51, 79, 80, 101, 113, 142, 149,
151, 152, 158, 165, 170, 173, 175,
183, 186, 209, 244, 248, 291, 304,
311, 352, 407, 416, 427, 439, 444,
451, 452, 455, 469, 506, 515, 550,
551, 559, 560, 581, 650, 660, 665,
688
- Kowarski, Lew, 310
- Kvidera, Myrtle, 87, 291, 311
- La Chapelle, Theodore J., 400,
415, 417, 425, 427, 492, 493, 550,
577, 579, 588, 665, 686, 688
- Lacher, J. R., 662
- La Crosse, Emmart, 293, 298, 299,
302
- Lad, R. A., 522
- Laitinen, H. A., 115, 244, 249,
310
- Lamb, Arthur B., 662
- La Mer, Victor, 38
- Lane, James A., 640, 649, 676
- Lane, Helen, 682
- Lange, Howard W., vi, 464
- Langsdorf, Alexander, 26, 44, 45,
242, 479, 508, 582, 602, 613, 616,
619, 651
- Latimer, Wendell M., 16, 18, 26,
27, 33, 44-46, 52, 55, 60, 61, 64,
71, 76, 84, 89, 99, 102, 109, 112-
114, 126-128, 138, 143, 155, 156,
157, 166, 168, 176, 182, 184, 204,
209, 213, 218, 224, 260, 267, 268,
278, 292, 331, 363, 365, 369, 391,
394, 397, 412, 419, 420, 423, 424,
427, 434, 436, 446, 447, 469, 488,
492, 503, 505, 508, 528, 531, 547,
549, 565, 573, 636, 638, 666
- Lauritsen, Thomas, 359
- Lauterbach, Dorothy, 659
- Lauterbach, Richard E., 636, 658,
672
- Lawrence, Ernest O., 26, 34, 46, 53,
54, 67, 77, 89, 94, 147, 150, 153,
155, 160, 174, 214, 215, 236, 239,
240, 248, 261, 266, 278, 279, 288,
366, 367, 386, 412, 448, 637
- Lawrence, John, 166, 277, 391, 571
- Lawrence, Molly, 67
- Lawroski, Steve, vi
- Lee, Donald, 578
- Lemke, Valda M., 389, 452, 534,
- Levanas, Leo, 49, 52, 68, 494, 513
- Leverett, Miles C., 77, 83, 91, 100,
108, 111, 169, 174, 256, 361, 431,
494, 534, 547, 555, 556, 602, 614,
681
- Leverett, Nancy, 534
- Levinger, S. J., 217
- Lewis, Gilbert N., 18, 54, 64, 84,
208
- Lewis, Warren K., 255, 359, 367,
374, 377, 390, 394, 395, 412
- Lewitz, Elaine, 513
- Libby, Willard F., 36, 38, 79, 99,
603, 614, 648
- Lichtenberger, Harold, 17
- Lindner, Robert, 433
- Lingane, James J., 520, 525, 533,
540
- Lipkin, David, 166, 480, 513
- Livingston, H. K., 573
- Lockhart, C. C., 430
- Lofgren, N. L., 492
- Long, Earl, 36, 38
- Macy, Harry, vi
- Magel, Theodore T., 46, 48, 55, 56,
79, 80, 101, 105, 113, 140, 142, 149,
149, 151, 152, 165, 209, 244, 248,
291, 304, 311, 312, 327, 329, 340,
345, 349, 373, 401, 432, 437, 441,
443, 464, 474, 487, 491, 505, 513,
517, 562, 564, 566, 592, 596, 597,
613, 620, 652, 663, 669, 670, 688
- Makower, Benjamin, 424
- Mallinckrodt, Edward, 662
- Malm, John, vi
- Maloney, J. O., 578, 641, 667

Manley, John H., 75,93,115,116,
 127,142,143,156,168,223,256,
 273,326,337,353,374,392,393,
 408,473,530,622,630
 Marshall, Colonel, 253,254,293,
 298,631,653
 Mastick, D. F., 420
 Mayer, Joseph, 653
 Mayer, Maria, 653
 Melhase, Margaret, 18
 Merritt P. L., 403
 Meyers, Robert, 573
 Miles, John B., 560,565,575,595,
 598,601,614,616,621,641,653,
 671,677,683
 Miller, Daniel R., 493,577,588,
 592,612,635,647,662,664,679,
 686,688
 Mills, G. F., 668
 Mitchell, A. C. G., 93,111,123,
 124,270,316,320,357,419,427,
 471
 Moore, Annis, 480,481,575,639,
 688
 Moore, Tom V., 14,30,73,77,83,
 84,86,91,93,94,100,101,108,
 118-120,130,145,146,159,174,
 208,214,224,253,255,269-271,
 273,284,285,287,289,293,298,
 307,314,315,354,357,358,361,
 376,392,394,408,430,431,437,
 444,535,681
 Moquin, Lois, 54,168,183,281,
 492
 Morris, Humbert, 589,610
 Morrison, Philip, 541,675
 Motta, Ercole E., 170
 Moulton, C. Robert, 198,229,
 246,414,425,448,456,471,473,
 518,538,580,596,604,623
 Muller, Ralph H., 37
 Mulliken, R. S., 333,362,414,
 475,488,494,517,525,542,556,
 560,584,595,676,677,683
 Murayama, Makio, 429,442
 Murphree, Eger V., 14,37,239,
 248,254,293,298,299,359,366,
 367,377
 Murray, Forrest H., 420

 MacArthur, Douglas, 433
 MacTavish, W. C., 47,49
 McBride, John P., 666

 McClinton, Leslie T., 666
 McCoy, Herbert N., 9,10,71
 McKibben, J. L., 256
 McLellan, F., 430
 McMillan, Edwin M., 273,274,
 366,367,424

 Neubert, Theodore J., 392,421,
 669
 Newson, Henry, W., 357,394,395,
 408,411,468,505,649
 Newton, Amos S., 40,357,485
 Nichols, Kenneth D., 224,248,
 253,293,298
 Nickson, James, 198
 Nier, Alfred O. C., 36,562,687

 O'Donnell, Thomas, 441
 Ohlinger, Leo A., 475,614
 Olson, A. R., 64,492,547
 Olson, Carl M., 541,598,610,
 641,645,667
 Oppenheimer, J. Robert, 75,76,
 110,116,127,215,248,268-271,
 273,274,286,287,293,325,337,
 366,367,374,377,424,445,446,
 473,498,502,528,530,541,562,
 571,619,622,641,653,655
 Orlemann, Edwin F., 55,446,448,
 462,509,512,516,540,579,581,
 582,588,593,598,609,610,620,
 645,659,669,683,688
 Orr, W. C., 492
 Osborne, Darrell W., 18,31
 Ostapowicz, Julius, 464
 Overbeck, W. P., 550,558

 Paden, William G., 218
 Paneth, Fritz A., 499,528
 Pardee, F. W., Jr., 293,298,
 331,336
 Parker, Herbert M., 649,631
 Patton, Robert L., 523,533,546,
 567,580,619,620,656,660,669,
 671,674,679,683,687,688
 Paulsen, Robert, 452,659,688
 Pearson, Charlotte, 590
 Peery, Luther C., vi,219,311,
 351,352,440,534,598,599,640,
 644,649,655,679
 Perlman, Isadore, vi,1,2,5,7,8,
 12,13,17,19,25,26,29,34,36,
 40,44,46-48,51,52,57-60,67,

Perlman, Isadore, (con't.)
 70-72,78,79,82,83,85,88,90,
 91,95,97,102,103,106,117,
 130,131,133,137,139,140,149,
 152,153,155,165,169,180,191,
 193,195,198,201,202,204,206,
 207,209,213,217,220-222,228,
 242,246,249,250-252,257,260,
 261,263,264,276,279-281,291,
 307,311,318-322,324-328,330,
 331,334,348,357,362,364,365,
 379,381,388,389,391,392,399,
 400,401,416,417,421,426,440,
 441,443,449,451,452,459,462,
 464,473,480,493,499,503,506,
 508,510,516,542,547,550,553,
 569,571,575,581,583,587,593,
 594,596,598,609-611,618,620,
 635,639,645,649,651,652,655,
 657,659,664,669,671,673,676,
 682,683,685,688
 Perlman, Lee, 33,516
 Perlman, Morris, 46,55,65,125,
 211,238,447
 Perrin, Francis, 93
 Peterson, Arthur V., 341,421,
 468,475,484,488,534,547,573,
 625,641
 Peterson, James H., 541,616,
 641,667,679
 Peterson, Marian, 603
 Peterson Merlin D., 445,455,
 469,494,517,525,534,536,551,
 551,556,575,576,603,640,644,
 649,662,679,683
 Pettitt, E. Newman, vi
 Pimentel, George, 453,492
 Pitts, J. N., 546
 Pitzer, Kenneth, 64,65
 Placzek, George, 499
 Plass, Gilbert, 17,135
 Plass, John, 17,135
 Pontecorvo, Bruno, 499
 Porter, C. W., 64
 Potratz, Herbert A., 130,170,
 574,595,677
 Pregel, Boris, 409
 Prestwood, René J., 26,34,44,
 67,83,133,134,176,213,214,
 324,327,350,447,470,571,589
 Purnell, William R., 269
 Randall, Merle, 59,528,562,565,
 576,591
 Reed, Ned R., 34,213,214,492
 Richards, H. T., 256
 Riley, Harold P., 541
 Robinson, Herman, vi
 Rochford, Paul E., 424,436,453,
 490,578,581
 Rodden, C. J., 71,383,384,580
 Rodger, W. A., 640
 Rollefson, G. K., 64,127,492,
 546,555,574,582,583,604
 Rommel, Erwin, 220,231,334,347,
 416,418,479,491,534,537,550,
 552,572,599,603,622,645
 Roof, Jack, 546
 Roosevelt, Franklin D., 88,93,
 171,337,347,399,412,486,492
 Rosenfels, Richard S., 414,429,
 447,448,473,540,587,593,596,
 598,603,609,620,646,663,669,
 679,683,685,688
 Ruben, Samuel, 16
 Rubinson, W., 525
 Rudolph, D. P., 459
 Ruhoff, John R., 87,89,94,120,
 130,131,143,155,291,403,682
 Rundle, Robert E., 9-11
 Russell, E. R., 598,641,667
 Russell, Lois, 672
 Saunders, Bernard G., v,356
 Saunders, Paul, 31,34,47,48
 Schlesinger, Herman, 32,94,522,
 533,609,623,648
 Schmidt, Fred H., 356
 Schroeder, Roy C., 179,311,312,
 484
 Schubert, J., 598,616,667
 Schulze, Paul A., vi,522,651,688
 Schutz, Phil, 36,38
 Scott, Benjamin F., Jr., vi,567,
 683,688
 Seaborg, Helen L., iv,vi,2,8,14,
 16,18,24,25,27,29,32,35,36,39,
 40,45,48-52,54,56-58,60-62,64,
 68-70,77,79,85,87,90,95,99,103,
 107,108,114,125,131,145,171,
 175,182,184,186,192,203,204,
 214,241,251,258-260,272,273,
 281,331,347,380,387,400,431,
 433,456,494,503,509,512,513,
 516,518,522,524,525,528,530,
 536,543,545,547,554,556,563,
 565,567,569,570-572,574,577,
 579,580,584,586,590,591,595,

Seaborg, Helen L., (con't.)
597,598,603,606,610,611,615,
617,632,635,639,644,646,649,
651,653,655,658,659,661,666,
672,675,676,678,682

Seaborg, Jeanette, 68

Seaborg, Peter, vi

Seaborg, Theodore, Mr. & Mrs., 68

Sedlet, Jake, vi

Segrè, Emilio, 41,103,159,236,
256,393,544,570,614,633,636

Serber, Robert, 374

Shapiro, Edward, 420,584,669,677

Sheft, Irving, vi,522,623,665,
686,688

Sheldon, Clayton, 68

Sheldon, Rita, 68

Sheline, Glenn E., 34,67,133,
176,213,214,276,305,327,350,
402,471,492,564,589,666,676-
678

Shepard, Donald, 650,660,665

Siegel, Samuel, 546

Simmons, Julius M., 596

Simpson, Oliver, vi

Skei, T., 546

Slotin, Louis, 17

Smith, Clifford, vi,429,447
473,448,516,568,586,596,639,
664,669,679,683,685,688

Smith, Edrey, v,291,292,324,
325,400,456,464,480,481,575,
639,688

Smith, W. Q., 312,364,379,392,
394,395,441,494,495,503,504,
534,545,548,551,557,558,560,
564,565,571,585,598,602,616-
618,640,641,644,649,655,657,
658,667,668,680-682

Smyth, Henry D., 653,654,684

Snell, Arthur H., 17,123,160,
217,525,526

Somervell, Brehon B., 94

Spector, N. A., 581

Spedding, Frank H., 9,10,12-14,
30,33,41,48,53,58,71,73,74,
77,83,84,88,93,100,108,115,
120,130,131,156,159,174,208,
214,224,253,293,315,319,333,
358,360,361,374-376,379,392,
408,421,427,437,441,444,464,
471,475,477,485,488,494,503,
505,515,517,525,533,542,557,
565,575,584,589,595,601,606,
615,621,653,671,677,683

Spence, Roderick W., 541

Sperry, Milicent, 67

Sproul, Robert G., 230,446

Squires, Lombard, 445,585,616,
618,655,657

Stearns, Joyce C., 5,17,29,48,
51,58,59,74,93,107,108,293,
362,373,374,394,395,408,411,
461,467,488,494,503,505,525,
531,626,632,671,682,683

Steinbach, E., 130,174,200,208,
214,222,224,253,255,271,274,
284,285,293,298,357

Steinberg, Ellis, vi

Stephens, Sophie, vi

Stewart, Irvin, 565

Stewart, T. D., 64

Stimson, Henry L., 93,269

Stine, C. M. A., 331,359

Stone, Robert S., 248,256,277,
303,387,410,475-477,484,494,
503,517,595,601,614,621,628,
641,653,654,671,683

Stoughton, Raymond W., 7,8,19,
34,42,44,61,67,76,89,95-97,
115,116,125,128,133,167,168,
209,257,266,272,402,405,419,
447,448,455,471,508,512,515,
516,524,570,579,588,594,598,
599,633,644,647,651,663,669,
675,677,686,688

Strait, Louis, 610,614,636,645,
668,669

Struthers, George W., 655

Styer, Wilhelm D., 94,269,593

Sugarman, Nathan, vi,508,525,
542,677

Sullivan, John H., 453,485

Sullivan, Lucartha P., 5,19,20,
25,34,70,76,359

Sullivan, W. H., 484,615

Summers, Mildred M., 534,688

Sutton, J. Bart, 493-495,504,
534,541,545,548,551,556-558,
560,564,573,585,610,616-618,
641,667,668,680,681

Swartout, J. A., 641,667

Szilard, Leo, 10,13,30,73,86,91,
93,100,106,108,111,118-120,
145,159,214,224,253,255,268,
273,284,287,289,293,297,307,

Szilard, Leo, (con't.)
 308,329,330,353,358,361,374,
 375,421,433

Tannenbaum, Albert, 628
 Tanzillo, A., 34
 Taube, Henry, 400,613,619,623
 Teller, Edward, 71,73,74,86-88,
 90,91,93,111,113,199,319,
 326,337,362,374,421,441,526
 Tharpe, Mary Jane, 639,688
 Thiele, Ernest W., 8,10,13,30,
 353
 Thompson, Alice, 203,380,571,
 579,603,658
 Thompson, Stanley G., vi,141,147,
 179,203,246,251,268,273,283,
 289,291,293,310,311,313,314,
 320,321,327,334,335,344,349,
 353,380,400,416,425-427,430,
 432,434,435,439,440,442,443,
 449,460,464,469,477,478,480,
 486,487,493,496,499,506,509,
 510,518,519,521,532,537,547,
 552,559,560,563,571,577,579,
 584,588,590,592,593,598,603,
 618,620,632,635,645,651,656,
 659,664,669,673,675,679,688
 Thon, N., 36
 Thornton, R. L., 248
 Tompkins, Frank, vi
 Tracy, Kay, 5
 Turk, Elton H., vi,80,103,114,
 115,137,141,146,147,152,158,
 161,170,171,173,177,186,205,
 209,225,250,283,288,311,349,
 363,435,439,443,455,460,464,
 469,476,550,577,579,588,602,
 635,660,665,686,688
 Turkevich, Anthony, 655

Uhlenbeck, G. E., 381
 Underhill, Robert M., 215
 Urey, Harold C., 8,11,13,25,56,
 78,94,156,160,239,248,254,
 288,354,385,526,527,531,591,
 602,614,615,624,653,671,684

Van Dorn, John F., 497
 Vatter, William J., 469
 Vaughan, Frank B., 219,361,421,
 441,553
 Vernon, Harcourt C., 338,614,684

Vincent, P. S., 219,311,640,649,
 679
 Vogwill, Wallace H., 99,128,179,
 311,312,658
 Voigt, Adolf F., 40,319,485
 Volman, David H., 546

Wade, H. S., 568
 Wahl, Arthur C., 5,7,8,13,17,27,
 34,41,46,49,62,65,85,92,100,
 104,109,111,113,122,125,127,
 128,132,133,151,152,155,167,
 183,209,211,213,223,228,233,
 238,243,264,278,292,309,324,
 329,331,333,335,353,356,402,
 424,445,447,470,533,549,589,
 632
 Walsh, Pat, vi
 Way, Katherine, 420
 Webster, Donald S., 219,246,248,
 262,276,311,351,352,640,649
 Webster, R. A., 492
 Weinberg, Alvin M., 135,362,411,
 525,526,535,569,614
 Weiss, F. T., 546
 Weissman, Sam, 490
 Wells, Robert Lee, 292,329
 Wensel, H. T., 35,266
 Werner, Louis B., vi,112,143,145,
 153,161,163,165,177,178,184,
 188-192,195,199,202,203,209,
 210,217,226,228,232,234,242,
 243,247,261-263,276,281,282,
 288,291,292,303-305,308,310-
 312,317,326,331,332,334,348,
 382,388,401,404,411,413,415,
 418,426,427,432,434,435,440,
 443,450,451,454,460,461,464,
 470,473,486,487,489,496,510,
 517,520,532,537,539,540,548,
 559,570,577,580,582,590,601,
 618,633,674,676,688
 West, George H., 528
 Wheeler, John A., 7,8,10,13,30,
 73,77,83,84,86-88,91,100,108,
 118,145,159,174,213,214,224,
 253,254,268-270,273,286,287,
 289,290,293,296-298,307,308,
 314,316,319,333,353,357,374,
 392,394,408,421,430,437,441,
 444,488,526,526,535,547,586,
 591,598,682

Whitaker, M. D., 17,93,100,120,
 130,134,145,156,200,208,214,
 216,222,223,270,271,273,279-
 281,284,290,338,357,358,362,
 374,390,395,408-411,430,468,
 472,481,491,494,510,526,527,
 529,535,557,600,601,617,621,
 624,629,644,649,653,669,671,
 672,677,683,684
 White, H., 546
 Wigner, Eugene, 8,10,17,30,71,
 73,84,86,87,93,108,118,120,
 135,145,159,174,198,214,224,
 268-271,273,284,285,287,289,
 293,297,307,308,314,333,354,
 358-361,374,392-394,408,437,
 444,475,476,488,494,517,526,
 530,535,542,603,614,621,671,
 677,681,683,684
 Wilhelm, Harley A., 8,10,13,485
 Wilkinson, R. G., 217
 Willard, John, vi,58,59,71,79,
 80,93,103,106,114,115,137,
 140,141,146,147,152,161,171,
 177,205,207,209,225,226,250,
 283,288,311,329,349,363,403,
 408,421,435,441,443,445,455,
 464,469,475-477,493,500,506,
 508,509,520,521,530,533-535,
 543,545,548,556,560,563,573,
 579,581,585,588,590,593,595,
 598,601,610,611,616,618,620,
 623,632,641,645,646,649,652,
 655,657,659,667,669,675,677,
 679,682,683,688
 Williams, J. H., 256
 Williams, Paul, 498
 Williams, Roger, 331,367,377,
 437,454
 Williams, T. C., 338
 Williamson, R. R., 135
 Wilson, H. A., 256
 Wilson, R. R., 681
 Wilson, Volney C., 73,77,83,84,
 91,93,100,108,174,182,293,
 295,430,468,494,505,550
 Winnick, Theodore, 372
 Winstein, Saul, 18,49,52,68,79,
 84,85,123,171,268,275,278,
 279,400,422,553,613,636
 Winstein, Sylvia, 613
 Winters, C. E., 662
 Wollan, E. O., 100,108,182,217,
 488,505,517,526,557,575,614,
 632
 Woodard, M. L., 492
 Worthington, Hood, 445
 Wu, Chien-Shiung, 103,159
 Yancey, E. B., 434
 York, Albert Foster, 292,329,
 364,386,512,517,544,546,551,
 570,575
 Yost, Don, 46,48,453
 Young, Fraser, 32,274,361,475,
 526,569,614
 Young, Robert B., 540,688
 Young, William G., 453
 Zechmeister, L., 575
 Zinn, Walter H., 30,93,100,134,
 159,223,293,390,433,434,468,
 526,532
 Zirkle, Raymond, 526,628,631

LAWRENCE BERKELEY LABORATORY
UNIVERSITY OF CALIFORNIA
INFORMATION RESOURCES DEPARTMENT
BERKELEY, CALIFORNIA 94720